

American National Standard

SAAMI Z299.4-2025

*Voluntary Industry Performance Standards
for Pressure and Velocity
of Centerfire Rifle Ammunition
for the Use of Commercial Manufacturers*

SAAMI[®]

SPORTING ARMS
& AMMUNITION

EST. 1926

MANUFACTURERS' INSTITUTE[®]

www.saami.org

*Voluntary Industry Performance Standards
for Pressure and Velocity
of Centerfire Rifle Ammunition
for the Use of Commercial Manufacturers*

Sponsor:

Sporting Arms and Ammunition Manufacturers' Institute, Inc.

Voting Members:

*Ammo Inc.
Beretta USA Corporation
Browning Arms Company
Colt's Manufacturing Company, LLC
Federal Cartridge Company
Fiocchi of America, Inc.
Glock, Inc.
Hodgdon Powder Company, Inc.
Hornady Manufacturing Company
Kahr Arms
North American Arms, Inc.
Northrop Grumman / New River Energetics*

*O.F. Mossberg & Sons, Inc.
Olin Corporation/Winchester Division
Q, LLC
Savage Arms, Inc.
SIG SAUER INC
Smith & Wesson Corp.
St. Marks Powder, Inc.
Sturm, Ruger & Co., Inc.
Taurus Holdings, Inc.
True Velocity Ammunition, LLC
Weatherby, Inc.*

Associate Members:

*Bachstein Consulting, LLC
FN America, LLC
Nosler, Inc.
Norma Precision USA
Quantum Ammunition, LLC*

Supporting & Affiliate Members:

*AAC Ammunition
Armscor Cartridge Inc.
Atlas Development Group, LLC
Barnes Bullets, LLC
Black Hills Ammunition, Inc.
Blackpowder Products, Inc. (d/b/a Bergara USA)
Bristol Ridge Precision, LLC
Capstone Precision Group
CZ-US Holdings, inc.
Daniel Defense, LLC
Defender Ammunition Company
Doubletap Ammunition, Inc.
Dynamic Research Technologies, LLC
Geissele Automatics
General Inspection, LLC
Henry Repeating Arms
H-S Precision, Inc.*

*Just Cause Solutions, LLC
Kent Cartridge, America
Liberty Ammunition
Oehler Research, Inc.
PCB Piezotronics, Inc.
Prospector Training, LLC
ROAM
Sierra Bullets LLC
Southern Ballistic Research, LLC d/b/a SBR
Specialty Cartridge Inc. (d/b/a Atlanta Arms)
The Hunting Shack Inc. (DBA: HSM)
Tippman Arms Co., LLC
Traditions Performance Firearms
TXAT LLC
Vairog USA
Wilson Combat*

Approved February 10, 2025

Abstract

In the interests of safety and interchangeability, this Standard provides pressure and velocity performance and dimensional characteristics for centerfire rifle sporting ammunition. Included are procedures and equipment for determining these criteria.

American National Standard

Approval of an American National Standard requires verification by ANSI that the requirements for due process, consensus, and other criteria for approval have been met by the standards developer.

Consensus is established when, in the judgment of the ANSI Board of Standards Review, substantial agreement has been reached by directly and materially affected interests. Substantial agreement means much more than a simple majority, but not necessarily unanimity. Consensus requires that all views and objections be considered, and that a concerted effort be made toward their resolution.

The use of American National Standards is completely voluntary; their existence does not in any respect preclude anyone, whether they have approved the standards or not, from manufacturing, marketing, purchasing, or using products, processes, or procedures not conforming to the standards.

The American National Standards Institute does not develop standards and will in no circumstances give an interpretation of any American National Standard. Moreover, no person shall have the right or authority to issue an interpretation of an American National Standard in the name of the American National Standards Institute. Requests for interpretation should be addressed to the secretariat or sponsor whose name appears on the title page of this standard.

CAUTION NOTICE: This American National Standard may be revised or withdrawn at any time. The procedures of the American National Standards Institute require that action be taken to reaffirm, revise, or withdraw this standard no later than five years from the date of approval. Purchasers of American National Standards may receive current information of all standards by calling or writing the American National Standards Institute.

Published by

Sporting Arms and Ammunition Manufacturers' Institute, Inc.

www.saami.org

Copyright © 2025 by
Sporting Arms and Ammunition Manufacturers' Institute, Inc.
All rights Reserved.

No part of this publication may be reproduced in any form, in an electronic retrieval system or otherwise, without the prior written permission of the publisher.

Printed in the United States of America

Note: This foreword is not part of SAAMI Z299.4-2025

Foreword

The development of this voluntary industry performance standard was initiated under the auspices of the Sporting Arms and Ammunition Manufacturers' Institute, Inc. (SAAMI). A Products Standards Task Force was established by the Institute in 1975 and charged with the drafting of this and other standards with their subsequent periodic revisions.

The material presented provides the commercial manufacturer of factory-loaded ammunition with pressure and velocity performance and dimensional characteristics. Included are procedures and equipment for determining these criteria. For the purpose of this standard a commercial manufacturer is defined as one who produces ammunition by fabricating component parts from raw materials as opposed to remanufacture with parts originally made by others.

This standard for Centerfire Rifle Sporting Ammunition was first published in 1979 and periodically updated until this revision in 2025. Changes in the standard with each revision include minor adjustments of velocities, the addition of new load offerings, updating of recommended equipment sources and the latest procedures for reporting reference ammunition assessments. Many of the drawings contained in this standard have been revised to reflect a change in the method used to calculate reference, or driven, dimensions which resulted in no or small (mostly $\leq 0.003''$ / 0.001mm) adjustments. Specific details on drawing revisions can be obtained by contacting the SAAMI Office.

Suggestions for improvement of this standard are welcome. They should be sent to: admin@saami.org.

SAAMI's criteria for obtaining consensus on all proposed standards is a majority of the consensus body casting a vote (counting abstentions) and at least two-thirds (2/3) of those voting approve (not counting abstentions).

The consensus body for this standard consisted of the following individuals and their respective affiliations.

<u>Interest Category</u>	<u>Name</u>	<u>Affiliation</u>
Expert	Buford Boone	Boone Ballistics
Expert	Earl Griffith	Individual, Retired Chief Firearms and Ammunition Technology Division, Bureau of Alcohol, Tobacco Firearms and Explosives (ATF)
Expert	James E. Hamby	Association of Firearms & Tool Mark Examiners
General Interest	Randy Bimson	Retired Firearm Design Engineer, Journeyman Gunsmith and Avid User
General Interest	Gentry Boswell	Individual, Retired US Air Force General Officer, Competitive Shooter, Avid User
General Interest	Ken Kees	Individual, Retired Ammunition Engineer and Avid User
Government	Jason Armstrong	The Bureau of Alcohol, Tobacco, Firearms and Explosives (ATF) - Firearms & Ammunition Technology Division
Government	Lowell Johnson	Department of Homeland Security (DHS) –National Armory
Government	Mark Greene	National Institute of Justice (NIJ) - Office of Technology and Standards
Government	A. Scott Patterson	Federal Bureau of Investigation (FBI) – Ballistic Research Facility
Producer	Adelar Garcia	Companhia Brasileira de Cartuchos (CBC)
Producer	Raymond Gross	Manson Precision Reamers
Producer	Melissa Maze	PCB Piezotronics, Inc.
Producer	John Miller	DEWESoft, LLC
Testing Laboratory	Dan Gubernat	United States Army Research Laboratory
Testing Laboratory	Jennifer Long	Dayton T. Brown, Inc.
Testing Laboratory	Matt Rixham	NTS Technical Systems
User	Jennifer Floyd	Arkansas State Crime Lab
User	Samuel Perry	Birmingham Proof House
User	Jeromey Schroeder	Royal Canadian Mounted Police (RCMP)
User	Cody Walton	Naval Surface Warfare Center, Crane Division

TABLE OF CONTENTS

<u>SECTION I – CHARACTERISTICS</u>	<u>PAGE</u>
Cartridges and Chambers	
Full and Abbreviated Names	1
Velocity & Pressure	
Velocity Data Interpretation	5
Factors Affecting Pressure Measurements.....	6
Explanation of Pressure Terminology	8
Explanation of Pressure Measuring Systems.....	10
Velocity & Pressure Data.....	11
Bullet Type Abbreviations.....	29
Primer	
Primers and Primer Pockets.....	30
Cartridge and Chamber Drawings	
6mm Advanced Rifle Cartridge.....	31
6mm Creedmoor	32
6mm GT	33
6mm Remington.....	34
6.5 Creedmoor.....	35
6.5 Grendel.....	36
6.5 Precision Rifle Cartridge.....	37
6.5 Weatherby Rebased Precision Magnum.....	38
6.5-284 Norma	39
6.5-300 Weatherby Magnum	40
6.5x55 Swedish	41
6.8 True Velocity Composite.....	42
6.8 Western	43
6.8mm Remington SPC	44
7mm Mauser (7x57).....	45
7mm Precision Rifle Cartridge	46
7mm Remington Magnum.....	47
7mm Remington Short Action Ultra Magnum	48
7mm Remington Ultra Magnum.....	49
7mm Weatherby Magnum	50
7mm Winchester Short Magnum.....	51
7mm-08 Remington	52
7 x 64 Brenneke	53
7.62 x 39	54
8mm Mauser (8x57).....	55
9.3 x 62	56
17 Hornet	57
17 Remington.....	58
17 Remington Fireball	59
204 Ruger.....	60
218 Bee	61
22 Advanced Rifle Cartridge	62
22 Creedmoor	63

22 Hornet	64
22 Nosler.....	65
22-250 Remington	66
220 Swift.....	67
221 Remington Fireball	68
222 Remington.....	69
222 Remington Magnum	70
223 Remington.....	71
223 Winchester Super Short Magnum.....	72
224 Valkyrie	73
243 Winchester	74
243 Winchester Super Short Magnum.....	75
25 Winchester Super Short Magnum.....	76
25-06 Remington	77
25-20 Winchester.....	78
25-35 Winchester.....	79
250 Savage.....	80
257 Roberts.....	81
257 Roberts +P	81
257 Weatherby Magnum	82
26 Nosler.....	83
260 Remington.....	84
264 Winchester Magnum.....	85
27 Nosler.....	86
270 Weatherby Magnum	87
270 Winchester	88
270 Winchester Short Magnum.....	89
277 SIG Fury	90
28 Nosler.....	91
280 Ackley Improved	92
280 Remington.....	93
284 Winchester	94
30 Carbine.....	95
30 Nosler.....	96
30 Remington AR.....	97
30 Thompson Center.....	98
30-06 Springfield.....	99
30-30 Winchester.....	100
30-40 Krag.....	101
300 AAC Blackout.....	102
300 HAM'R	103
300 Holland & Holland Magnum	104
300 Norma Magnum.....	105
300 Precision Rifle Cartridge	106
300 Remington Short Action Ultra Magnum	107
300 Remington Ultra Magnum	108
300 Ruger Compact Magnum.....	109
300 Savage.....	110
300 Weatherby Magnum	111

300 Winchester Magnum.....	112
300 Winchester Short Magnum	113
303 British.....	114
307 Winchester	115
308 Marlin Express.....	116
308 Winchester	117
32 Winchester Special	118
32-20 Winchester.....	119
325 Winchester Short Magnum.....	120
33 Nosler.....	121
338 Federal	122
338 Lapua Magnum.....	123
338 Marlin Express.....	124
338 Norma Magnum.....	125
338 Remington Ultra Magnum.....	126
338 Ruger Compact Magnum.....	127
338 Weatherby Rebated Precision Magnum	128
338 Winchester Magnum.....	129
340 Weatherby Magnum	130
348 Winchester	131
35 Remington.....	132
35 Whelen.....	133
350 Legend	134
356 Winchester	135
358 Winchester	136
360 Buckhammer.....	137
370 Sako Magnum.....	138
375 Holland & Holland Magnum	139
375 Remington Ultra Magnum.....	140
375 Ruger.....	141
375 Winchester	142
376 Steyr.....	143
38-40 Winchester.....	144
38-55 Winchester.....	145
400 Legend	146
405 Winchester	147
416 Remington Magnum	148
416 Rigby.....	149
416 Ruger.....	150
416 Weatherby Magnum	151
44 Remington Magnum	152
44-40 Winchester	153
444 Marlin.....	154
45-70 Government	155
450 Bushmaster.....	156
450 Marlin.....	157
458 Lott.....	158
458 Winchester Magnum.....	159
470 Nitro Express	160

500 Nitro Express 3”161

Miscellaneous

Dummy Cartridge – Gun Functioning162

Dummy Cartridge – Display163

Tolerance – Bullet Weight164

SECTION II - PROCEDURES

Velocity and Pressure

Procedure: Velocity & Pressure Testing165

Velocity & Pressure Barrels: Qualification172

Velocity & Pressure Barrels: Mounting in Receivers173

Procedure: Use of Piston Hole Gauges174

Procedure: Piezoelectric Transducer Calibration175

Transducer Calibration: Increments and Ranges179

Transducer Calibration: Equipment Interconnection184

Transducer Calibration: Least Square Line Computation185

Firing Test: Equipment Interconnection187

Reference Ammunition

Use189

Secondary Reference Ammunition191

New Lots192

Identification Protocol196

Periodic Assessment197

SECTION III – EQUIPMENT

Equipment: Velocity & Pressure Testing201

Copper Crushers

Usage of Crusher Cylinders in Pressure Testing203

Sample Tarage Tables204

Crusher Cylinders: Dimensions - .146” x .400”206

Crusher Cylinders: Dimensions - .225” x .400”207

Gas Checks

Equipment: .146” and .206” Gas Checks208

Equipment: Gas Check Tools – Seating and Knockout209

Pistons & Piston Holes

Equipment: Pistons and Piston Holes210

Equipment: Piston Hole Gauges217

Piston Oil – Piston and Gas Check219

Headspace Gauges

Headspace Gauges220

Reference Ammunition

Equipment: Reference Ammunition Supply231

Equipment: Reference Ammunition Order Procedure232

Miscellaneous

Supplier Contact Information233

Equipment: Schematic Layout of Velocity Screens234

Equipment: Universal Receiver Collar and Test Barrel235

Universal Receiver Test Barrel: Installation of Pressure Transducers	237
Equipment: Transducer Calibration Fixture Plug with O-ring Seal	240
Transducer Location and Selection Criteria	241
Standard V&P Test Barrels - General	
Procedures for Dimensioning Chambers	242
Procedures for Measuring Barrel Length.....	243
Standard Velocity and Pressure Test Barrels	
6mm Advanced Rifle Cartridge	244
6mm Creedmoor	245
6mm GT	246
6mm Remington.....	247
6.5 Creedmoor.....	248
6.5 Grendel.....	249
6.5 Precision Rifle Cartridge.....	250
6.5 Weatherby Rebased Precision Magnum.....	251
6.5-284 Norma	252
6.5-300 Weatherby Magnum	253
6.5x55 Swedish	254
6.8 True Velocity Composite.....	255
6.8 Western	256
6.8mm Remington SPC	257
7mm Mauser (7x57).....	258
7mm Precision Rifle Cartridge	259
7mm Remington Magnum	260
7mm Remington Short Action Ultra Magnum	261
7mm Remington Ultra Magnum.....	262
7mm Weatherby Magnum	263
7mm Winchester Short Magnum.....	264
7mm-08 Remington.....	265
7 x 64 Brenneke	266
7.62 x 39	267
8mm Mauser (8x57).....	268
9.3 x 62	269
17 Hornet	270
17 Remington.....	271
17 Remington Fireball	272
204 Ruger.....	273
218 Bee	274
22 Advanced Rifle Cartridge	275
22 Creedmoor	276
22 Hornet	277
22 Nosler.....	278
22-250 Remington	279
220 Swift.....	280
221 Remington Fireball	281
222 Remington.....	282
222 Remington Magnum	283
223 Remington.....	284
223 Winchester Super Short Magnum.....	285

224 Valkyrie	286
243 Winchester	287
243 Winchester Super Short Magnum.....	288
25 Winchester Super Short Magnum.....	289
25-06 Remington	290
25-20 Winchester.....	291
25-35 Winchester.....	292
250 Savage.....	293
257 Roberts	294
257 Roberts +P	294
257 Weatherby Magnum	295
26 Nosler.....	296
260 Remington.....	297
264 Winchester Magnum.....	298
27 Nosler.....	299
270 Weatherby Magnum	300
270 Winchester	301
270 Winchester Short Magnum	302
277 SIG Fury	303
28 Nosler.....	304
280 Ackley Improved	305
280 Remington.....	306
284 Winchester	307
30 Carbine.....	308
30 Nosler.....	309
30 Remington AR	310
30 Thompson Center.....	311
30-06 Springfield.....	312
30-30 Winchester.....	313
30-40 Krag	314
300 AAC Blackout.....	315
300 HAM'R.....	316
300 Holland & Holland Magnum	317
300 Norma Magnum.....	318
300 Precision Rifle Cartridge	319
300 Remington Short Action Ultra Magnum	320
300 Remington Ultra Magnum.....	321
300 Ruger Compact Magnum.....	322
300 Savage.....	323
300 Weatherby Magnum	324
300 Winchester Magnum.....	325
300 Winchester Short Magnum	326
303 British.....	327
307 Winchester	328
308 Marlin Express.....	329
308 Winchester	330
32 Winchester Special	331
32-20 Winchester.....	332
325 Winchester Short Magnum.....	333

33 Nosler.....	334
338 Federal	335
338 Lapua Magnum.....	336
338 Marlin Express.....	337
338 Norma Magnum.....	338
338 Remington Ultra Magnum.....	339
338 Ruger Compact Magnum.....	340
338 Weatherby Rebated Precision Magnum	341
338 Winchester.....	342
340 Weatherby Magnum	343
348 Winchester	344
35 Remington.....	345
35 Whelen	346
350 Legend	347
356 Winchester	348
358 Winchester	349
360 Buckhammer.....	350
370 Sako Magnum.....	351
375 Holland & Holland Magnum	352
375 Remington Ultra Magnum.....	353
375 Ruger.....	354
375 Winchester	355
376 Steyr.....	356
38-40 Winchester.....	357
38-55 Winchester.....	358
400 Legend	359
405 Winchester	360
416 Remington Magnum	361
416 Rigby.....	362
416 Ruger.....	363
416 Weatherby Magnum	364
44 Remington Magnum	365
44-40 Winchester.....	366
444 Marlin.....	367
45-70 Government	368
450 Bushmaster.....	369
450 Marlin.....	370
458 Lott.....	371
458 Winchester Magnum.....	372
470 Nitro Express	373
500 Nitro Express 3”.....	374

SECTION IV – DEFINITIVE PROOF LOADS

Definition and Purpose	375
Proof Pressure Data Interpretation.....	376
Proof Pressure Data – Crusher.....	377
Proof Pressure Data – Transducer.....	381
Proof Load Supply	385
Proof Cartridge Identification.....	386

Definitive Proof Package Identification.....387

CARTRIDGES AND CHAMBERS FULL AND ABBREVIATED NAMES

The following list presents the recommended full names and abbreviated names of the centerfire rifle cartridges and chambers currently supplied for various types of firearms.

These full or abbreviated names should be used on cartridge headstamps and on firearm markings to properly identify the caliber.

ORDER OF LISTING

Lists of centerfire rifle cartridges are arranged according to the following rules:

- 1) All Metric cartridges
 - a) First in ascending numerical order of approximate caliber designation,
 - b) Then in alphabetical order.
- 2) Followed by American cartridges
 - a) First in ascending numerical order of approximate caliber designation,
 - b) Then alphabetical order.
- 3) Within each of the above groups, cartridges are arranged in order of:
 - a) 2-digit numbers,
 - b) 2-digit numbers and a hyphen followed by more numbers,
 - c) 3-digit numbers.

For lists that present both cartridge name and several bullet weights, list in ascending numerical order of bullet weights.

Active Cartridges and Chambers

<u>Full Name</u>	<u>Abbreviated Name</u>
6mm Advanced Rifle Cartridge.....	6mm ARC
6mm Creedmoor	6mm CM
6mm GT.....	6mm GT
6mm Remington.....	6mm REM
6.5 Creedmoor.....	6.5 CM
6.5 Grendel.....	6.5 GREN
6.5 Precision Rifle Cartridge.....	6.5 PRC
6.5 Weatherby Rebated Precision Magnum.....	6.5 WBYP
6.5-284 Norma	6.5-284
6.5-300 Weatherby Magnum	6.5-300 WBYP
6.5x55 Swedish	6.5x55
6.8 True Velocity Composite.....	6.8 TVC
6.8 Western	6.8 WESTERN
6.8mm Remington SPC	6.8mm REM SPC
7mm Mauser (7x57).....	7mm (7x57)
7mm Precision Rifle Cartridge	7mm PRC
7mm Remington Magnum	7mm REM MAG

7mm Remington Short Action Ultra Magnum ...	7mm REM SA ULTRA MAG
7mm Remington Ultra Magnum	7mm REM ULTRA MAG
7mm Weatherby Magnum	7mm WBY MAG
7mm Winchester Short Magnum	7mm WSM
7mm-08 Remington	7mm-08 REM
7 x 64 Brenneke	7x64
7.62 x 39.....	7.62x39
8mm Mauser (8x57).....	8mm (8x57)
9.3 x 62.....	9.3 x 62
17 Hornet	17 HORNET
17 Remington.....	17 REM
17 Remington Fireball	17 REM FIREBALL
204 Ruger.....	204 RUGER
218 Bee	218 BEE
22 Advanced Rifle Cartridge	22 ARC
22 Creedmoor.....	22 CM
22 Hornet	22 HORNET
22 Nosler.....	22 NOSLER
22-250 Remington	22-250 REM
220 Swift.....	220 SWIFT
221 Remington Fireball	221 REM FIREBALL
222 Remington.....	222 REM
222 Remington Magnum	222 REM MAG
223 Remington.....	223 REM
223 Winchester Super Short Magnum	223 WSSM
224 Valkyrie.....	224 VLK
243 Winchester	243 WIN
243 Winchester Super Short Magnum	243 WSSM
25 Winchester Super Short Magnum	25 WSSM
25-06 Remington	25-06 REM
25-20 Winchester	25-20 WIN
25-35 Winchester	25-35 WIN
250 Savage	250 SAV
257 Roberts	257 ROB
257 Roberts +P.....	257 ROB +P*
257 Weatherby Magnum.....	257 WBY MAG
26 Nosler.....	26 NOSLER
260 Remington.....	260 REM
264 Winchester Magnum	264 WIN MAG
27 Nosler.....	27 NOSLER
270 Weatherby Magnum.....	270 WBY MAG

* This ammunition is loaded to a higher pressure, as indicated by the +P marking on the case headstamp, to achieve higher velocity. Use only in firearms especially designed for this cartridge and so recommended by the manufacturer.

270 Winchester	270 WIN
270 Winchester Short Magnum	270 WSM
277 SIG Fury.....	277 SIG FURY
28 Nosler.....	28 NOSLER
280 Ackley Improved	280 ACK IMP
280 Remington.....	280 REM
284 Winchester	284 WIN
30 Carbine.....	30 CARB
30 Nosler.....	30 NOSLER
30 Remington AR.....	30 REM AR
30 Thompson Center.....	30 TC
30-06 Springfield	30-06 SPRG
30-30 Winchester.....	30-30 WIN
30-40 Krag	30-40 KRAG
300 AAC Blackout.....	300 BLK
300 HAM'R	300 HAMR
300 Holland & Holland Magnum	300 H&H MAG
300 Norma Magnum.....	300 NM
300 Precision Rifle Cartridge.....	300 PRC
300 Remington Short Action Ultra Magnum.....	300 REM SA ULTRA MAG
300 Remington Ultra Magnum	300 REM ULTRA MAG
300 Ruger Compact Magnum.....	300 RCM
300 Savage.....	300 SAV
300 Weatherby Magnum.....	300 WBV MAG
300 Winchester Magnum.....	300 WIN MAG
300 Winchester Short Magnum	300 WSM
303 British.....	303 BRIT
307 Winchester	307 WIN
308 Marlin Express	308 MAR EXP
308 Winchester	308 WIN
32 Winchester Special.....	32 WIN SPL
32-20 Winchester	32-20 WIN
325 Winchester Short Magnum	325 WSM
33 Nosler.....	33 NOSLER
338 Federal.....	338 FED
338 Lapua Magnum	338 LAPUA MAG
338 Norma Magnum.....	338 NM
338 Marlin Express.....	338 ME
338 Remington Ultra Magnum	338 REM ULTRA MAG
338 Ruger Compact Magnum.....	338 RCM
338 Weatherby Rebated Precision Magnum.....	338 WBV RPM
338 Winchester Magnum.....	338 WIN MAG
340 Weatherby Magnum.....	340 WBV MAG
348 Winchester	348 WIN

35 Remington.....	35 REM
35 Whelen.....	35 WHELEN
350 Legend.....	350 LGND
356 Winchester.....	356 WIN
358 Winchester.....	358 WIN
360 Buckhammer.....	360 BHMR
370 Sako Magnum.....	370 SAKO MAG
375 Holland & Holland Magnum.....	375 H&H MAG
375 Remington Ultra Magnum.....	375 REM ULTRA MAG
375 Ruger.....	375 RUGER
375 Winchester.....	375 WIN
376 Steyr.....	376 STEYR
38-40 Winchester.....	38-40 WIN
38-55 Winchester.....	38-55 WIN
400 Legend.....	400 LGND
405 Winchester.....	405 WIN
416 Remington Magnum.....	416 REM MAG
416 Rigby.....	416 RIGBY
416 Ruger.....	416 RUGER
416 Weatherby Magnum.....	416 WBY MAG
44 Remington Magnum.....	44 REM MAG
44-40 Winchester.....	44-40 WIN
444 Marlin.....	444 MAR
45-70 Government.....	45-70 GOVT
450 Bushmaster.....	450 BM
450 Marlin.....	450 MARLIN
458 Lott.....	458 LOTT
458 Winchester Magnum.....	458 WIN MAG
470 Nitro Express.....	470 NE
500 Nitro Express 3”.....	500 NE 3”

VELOCITY DATA INTERPRETATION

Velocity recommendations are stated on the basis of a nominal lot mean velocity as measured using equipment in accordance with the requirements of Section III and the procedures detailed in Section II. Due to the fact that sporting firearms for general distribution are typically manufactured to dimensional tolerances greater than those specified for test barrels, there should be no expectation that these velocities can be duplicated from any test utilizing firearms. This situation is further confounded by discrepancies in barrel length. Furthermore, once ammunition has left the control of the manufacturer, storage conditions outside those recommended by the manufacturer may cause variations in the velocity as measured using test equipment and procedures which conform to the requirements of this Standard.

The values presented on pages 11 through 28 are recommended values for the use of ammunition producers at the time of manufacture. It is the responsibility of the manufacturer to establish sample sizes, sampling frequencies, and tolerances to ensure the performance of the ammunition obtained by the ultimate user meets all applicable safety and functional standards. Of particular importance in establishing velocity tolerances is the understanding that velocities significantly higher than the nominal lot mean can cause actual maximum range performance to exceed expected values.

Ammunition tested subsequent to manufacture using equipment and procedures conforming to these guidelines can be expected to produce velocities within a tolerance of ± 90 fps of the tabulated values.

FACTORS AFFECTING PRESSURE MEASUREMENTS

Two principal methods of measuring centerfire rifle pressures are recognized: the copper crusher method and the piezoelectric transducer method. One or the other may be used or they may be used simultaneously.

There are three principal factors affecting pressure measurements. These are instrumentation, ammunition and procedure. The following lists present the items in each category that may cause difficulties in testing carried out with the two methods.

I. FACTORS IN COPPER CRUSHER TESTING

INSTRUMENTATION

1. Condition of test barrel (whether minimum or maximum bore, chamber size and headspace, amount of erosion at throat and bore).
2. Diameter of piston and piston hole.
3. Fit of piston in piston hole.
4. Location of piston hole.
5. Tightness of barrel mounting in Universal Receiver, if used.
6. Shape, size and protrusion of firing pin beyond breech face.
7. Force of firing pin blow.
8. Size, material and characteristics of the pressure-sensitive element of the gauge (copper crusher cylinders).
9. Type, size and condition of gas check.
10. Type of piston and gas check lubricant.
11. Quality and tolerance of piston hole gauges and headspace gauges.
12. Quality of crusher measuring instrument.

AMMUNITION

1. Condition of cartridge.
2. Position of powder in cartridge case.
3. Temperature of ammunition.

PROCEDURE

1. Failure to mount pressure barrel properly in Universal Receiver or other test action to assure minimum headspace.
2. Failure to rotate cartridge and close breech carefully to assure proper powder positioning.
3. Failure to wipe piston ends, crusher and setscrew face to remove excess oil.
4. Failure to center crusher cylinder on piston and properly adjust setscrew.
5. Failure to fire warming shots.
6. Overheating barrel by excessive rate of fire.
7. Failure to clean bore and control metal fouling.
8. Failure to clear barrel of brass disk blanked from the case wall and gas check from previous shot.

II. FACTORS IN PIEZOELECTRIC TRANSDUCER TESTING

INSTRUMENTATION

1. Condition of test barrel (whether minimum or maximum bore, chamber size and headspace, amount of erosion at throat and bore).
2. Fit of transducer in barrel.
3. Location of transducer.
4. Tightness of barrel mounting in Universal Receiver, if used.
5. Shape, size and protrusion of firing pin beyond breech face.
6. Force of firing pin blow.
7. Characteristics of the transducer.
8. Quality of the transducer.
9. Quality of the read-out system.

AMMUNITION

1. Condition of cartridge.
2. Position of powder in cartridge case.
3. Temperature of ammunition.

PROCEDURE

1. Failure to mount pressure barrel properly in Universal Receiver or other test action to assure minimum headspace.
2. Failure to rotate cartridge and close breech carefully to assure proper powder positioning.
3. Failure to fire warming shots.
4. Overheating barrel by excessive rate of fire.
5. Failure to clean bore and control metal fouling.
6. Failure to protect transducer against contamination, such as oil or water.
7. Transducer calibration.
8. Read-out system calibration.

EXPLANATION OF PRESSURE TERMINOLOGY

The SAAMI Pressure data outlined in this section is based on a Maximum Average Pressure for each cartridge and a Coefficient of Variation of 4%. The Coefficient of Variation (CV) of 4% was based on the CV that exists for the 50,000 psi pressure level and is calculated by dividing the population standard deviation ($\sigma = 2,000$ psi) by the Maximum Average Pressure (MAP = 50,000 psi) which equals .04 (4%). All other pressure terminology is derived directly from these two terms.

SAAMI recognizes two pressure-measuring systems. The preferred system is the piezoelectric transducer system with the transducer flush-mounted in the chamber of the test barrel. Pressure developed by the burning propellant exerts force on the transducer through the cartridge case wall causing the transducer to deflect, creating a measurable electric charge. Pressures measured with this system are expressed in units of "pounds per square inch" (abbreviated psi).

The second, older system employs a copper crusher cylinder which is compressed by a piston fitted to a piston hole into the chamber of the test barrel. Pressure generated by the burning propellant acts on the base of the piston forcing the piston to move, thereby permanently compressing the copper cylinder. Pressures measured by this system are expressed in "Copper Units of Pressure (abbreviated as CUP).

Throughout the following text the pressure is expressed in terms of "pounds per square inch" (psi) however, it should be understood that the same procedures apply to pressures expressed in "Copper Units of Pressure" (CUP).

Maximum Average Pressure - is the recommended maximum pressure level for loading commercial sporting ammunition. This pressure level is positioned two standard errors below the Maximum Probable Lot Mean (MPLM) pressure in order to assure there is a 97.5% probability that the Maximum Probable Lot Mean pressure is not exceeded. See Figure 1, below.

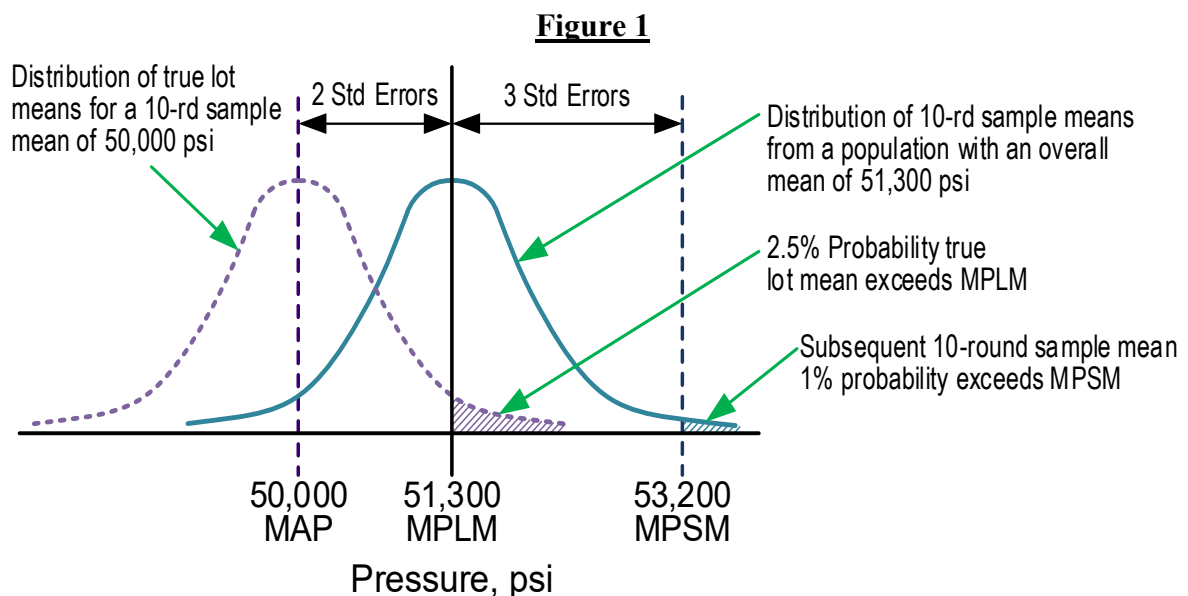

Standard Deviation (σ) - The Standard Deviation for each Maximum Average Pressure Level is based on a Coefficient of Variation of 4%. This 4% Coefficient of Variation is maintained throughout the

SAAMI pressure spectrum providing a realistic Standard Deviation for each pressure level. To obtain the Standard Deviation for a particular MAP, multiply the MAP by .04 (i.e., 50,000 psi x .04 = 2,000 psi).

Standard Error (σ_x) - The standard error is calculated by dividing the Standard Deviation (population S. D. = σ) by the square root of the sample size $\sigma_x = \sigma/\sqrt{n}$

Maximum Probable Lot Mean (MPLM) - The MPLM is calculated by adding two standard errors to the Maximum Average Pressure.

The SAAMI pressures are calculated based on a sample size of ten (10). The Maximum Probable Lot Mean represents the midpoint of the upper service pressure distribution. See Figure 1. For example, if the Maximum Average Pressure is 50,000 psi, the Maximum Probable Lot Mean (MPLM) is calculated as follows:

$$\text{MPLM} = \text{Maximum Average Pressure} + 2 \text{ standard errors}$$

$$\text{MPLM} = 50,000 \text{ psi} + [(50,000 \text{ psi} \times .04)/\sqrt{10}] \times 2$$

$$\text{MPLM} = 50,000 \text{ psi} + (633 \text{ psi} \times 2) = 50,000 \text{ psi} + 1266 \text{ psi} = 51,266 \text{ psi rounded to 51,300 psi}$$

Maximum Probable Sample Mean (MPSM) - is the maximum expected average pressure that may be observed in the testing of product subsequent to its manufacture and is not intended for use as a loading control point. The Maximum Probable Sample Mean is positioned three (3) standard errors above the Maximum Probable Lot Mean i.e., $\text{MPLM} + 3\sigma_x$. See Figure 1. The Maximum Probable Sample Mean defined here is the value previously referred to in the ANSI/SAAMI Standards as the Maximum Product Average.

Maximum Extreme Variation - The maximum allowable sample E.V. (Extreme Variation or Range) is a statistic derived from the knowledge of the population Standard Deviation. Applying table figures from the Relative Range Tables (Biometrika Tables for Statisticians) we calculate the Maximum E.V. or Range as (population σ) x 5.16 (table constant for sample of 10 at 99.0% confidence level) i.e., 2,000 psi x 5.16 = 10,320 psi rounded down to 10,300 psi.

EXPLANATION OF PRESSURE MEASURING SYSTEMS

The two SAAMI-recognized pressure-measuring systems for centerfire rifle cartridges are the copper crusher system and the piezoelectric transducer system.

A brief explanation of these two systems follows:

COPPER CRUSHER SYSTEM

This system employs a copper crusher cylinder that is compressed by a piston fitted to a piston hole into the chamber of the test barrel. The pressure developed by the gases from the burning propellant acts through the piston hole, allowing the gases to force the piston upward, and thereby permanently compressing the copper crusher cylinder. The Sporting Arms and Ammunition Manufacturers' Institute has adopted the pressure units designation of "Copper Units of Pressure" (abbreviated CUP) for this system. This designation applies only to values obtained using the particular crushers, tarage tables and methods outlined in this Standard.

PIEZOELECTRIC TRANSDUCER SYSTEM

This system employs a piezoelectric transducer flush mounted in the chamber of the test barrel. Pressure developed by the gases from the burning propellant exerts force on the transducer through the cartridge case wall causing the transducer to deflect, creating a measurable electric charge. This electrical charge is converted into a reading of pressure.

The Sporting Arms and Ammunition Manufacturers' Institute has adopted the pressure units designation of "pounds per square inch" (abbreviated psi) for this system. This designation applies to values obtained with transducers and methods as outlined in this Standard.

VELOCITY AND PRESSURE: VELOCITY & PRESSURE DATA

NOTE: In some instances, multiple nominal instrumental velocities are provided for a single bullet weight due to multiple introductions representing loads intended to meet certain market needs, such as reduced recoil loads, or where technological changes, such as propellant advancements or loading techniques, have allowed for the achievement of higher velocities after the introduction of the original load.

Cartridge	Bullet Weight (gr.)	Velocity, fps Nominal Mean Instrumental @ 15' Test Bbl.	CRUSHER Pressure, CUP/100 ⁽¹⁾			TRANSDUCER Pressure psi/100 ⁽¹⁾		
			Maximum Average Pressure MAP	Maximum Probable Lot Mean MPLM	Maximum Probable Sample Mean MPSM	Maximum Average Pressure MAP	Maximum Probable Lot Mean MPLM	Maximum Probable Sample Mean MPSM
6mm Advanced Rifle Cartridge	108	2,700	Crusher Pressures Not Established			520	533	553
6mm Creedmoor	87	3,200	Crusher Pressures Not Established			620	636	660
	108	2,950						
6mm GT	109	2,910	Crusher Pressures Not Established			620	636	660
6mm Remington	75	3,400	520	533	553	650	666	691
	80	3,400						
	90	3,175						
	95	3,225						
	100	3,090						
6.5 Creedmoor	100	3,230	Crusher Pressures Not Established			620	636	660
	95	3,300						
	120	2,900						
	127	2,840						
	129	2,940						
6.5 Grendel	140	2,690	Crusher Pressures Not Established			620	636	660
	115	2,580						
6.5 Precision Rifle Cartridge	123	2,580	Crusher Pressures Not Established			520	533	553
	147	2,900						
6.5 Weatherby Rebrated Precision Magnum	140	3,075	Crusher Pressures Not Established			650	666	691
6.5-284 Norma	130	2,900	Crusher Pressures Not Established			580	595	617
6.5-300 Weatherby Magnum	127	3,400	Crusher Pressures Not Established			650	666	691

1 - Based on sample size n=10.

SECTION I – CHARACTERISTICS
 CENTERFIRE RIFLE
 SAAMI VOLUNTARY PERFORMANCE STANDARDS

VELOCITY AND PRESSURE:
 VELOCITY & PRESSURE DATA

Cartridge	Bullet Wt., gr.	Instrumental Velocity, fps	CRUSHER Pressure, CUP/100 ⁽¹⁾			TRANSDUCER Pressure psi/100 ⁽¹⁾		
			MAP	MPLM	MPSM	MAP	MPLM	MPSM
6.5 x 55 Swedish	129	2,750	460	472	489	510	523	542
	140	2,940						
		2,690						
6.8 True Velocity Composite	135	3,070	Crusher Pressures Not Established			700 ⁽²⁾	718	745
6.8 Western	175	2,840	Crusher Pressures Not Established			650	666	691
6.8mm Remington SPC	100	2,540	Crusher Pressures Not Established			550	564	585
	115	2,610						
		2,760						
7mm Mauser (7x57)	139	2,650	460	472	489	510	523	542
		2,820						
	145	2,680						
	154	2,600						
	160	2,500						
	175	2,420						
7mm Precision Rifle Cartridge	180	2,950	Crusher Pressures Not Established			650	666	691
7mm Remington Magnum	125	3,290	520	533	553	610	625	648
	139	3,150						
		3,230						
	140	2,700						
		3,085						
	150	2,990						
		3,100						
	154	3,035						
	160-162	2,940						
175	2,750							
	2,850							
7mm Remington Short Action Ultra Magnum	140	3,165	Crusher Pressures Not Established			650	666	691
	150	3,095						
	160	2,950						

1 - Based on sample size $n=10$.

2 – **WARNING:** Maximum Average Pressure levels greater than 65,000 psi may present increased risk of unsafe cartridge case or firearm rupture and thus require cartridge case and/or firearm designs that depart from traditional practices (materials, construction, and other design criteria).

SECTION I – CHARACTERISTICS
 CENTERFIRE RIFLE
 SAAMI VOLUNTARY PERFORMANCE STANDARDS

VELOCITY AND PRESSURE:
 VELOCITY & PRESSURE DATA

Cartridge	Bullet Wt., gr.	Instrumental Velocity, fps	CRUSHER Pressure, CUP/100 ⁽¹⁾			TRANSDUCER Pressure psi/100 ⁽¹⁾		
			MAP	MPLM	MPSM	MAP	MPLM	MPSM
7mm Remington Ultra Magnum	140	3,415	Crusher Pressures Not Established			650	666	691
	150	3,315						
	160	3,190						
	175	3,015						
7mm Weatherby Magnum	140	3,165	Crusher Pressures Not Established			650	666	691
	160	3,100						
	175	2,840						
7mm Winchester Short Magnum	140	3,225	Crusher Pressures Not Established			650	666	691
	150	3,100						
		3,200						
	160	2,975						
7mm-08 Remington	120	2,990	520	533	553	610	625	648
	139	2,980						
	140	2,845						
	150	2,650						
7x64 Brenneke	140	2,950	505	518	537	550	564	585
	160	2,600						
7.62 x 39 ⁽²⁾	123	2,350	500	518	532	450	461	478
8mm Mauser (8 x 57)	170	2,340	370	379	393	350	359	372
9.3 x 62	286	2,360	Crusher Pressures Not Established			575	590	612
17 Hornet	15½	3,860	Crusher Pressures Not Established			500	513	532
	20	3,625						
17 Remington	20	4,250	520	533	553	630	646	670
	25	4,000						

1 - Based on sample size $n=10$. (2) – Based on a 20" test barrel.

SECTION I – CHARACTERISTICS
 CENTERFIRE RIFLE
 SAAMI VOLUNTARY PERFORMANCE STANDARDS

VELOCITY AND PRESSURE:
 VELOCITY & PRESSURE DATA

Cartridge	Bullet Wt., gr.	Instrumental Velocity, fps	CRUSHER Pressure, CUP/100 ⁽¹⁾			TRANSDUCER Pressure psi/100 ⁽¹⁾		
			MAP	MPLM	MPSM	MAP	MPLM	MPSM
17 Remington Fireball	20	3,970	Crusher Pressures Not Established			550	564	585
	25	3,850						
204 Ruger	24	4,390	Crusher Pressures Not Established			575	590	612
	32	4,075						
	34	3,990						
	40	3,650						
	40	3,775						
	45	3,500						
218 Bee	46	2,725	400	410	425	350	359	372
22 Advanced Rifle Cartridge	75	3,075	Crusher Pressures Not Established			520	533	553
22 Creedmoor	80	3,250	Crusher Pressures Not Established			620	636	660
22 Hornet	30	3,150	430	441	457	490	502	521
	33	3,040						
	34	2,985						
	35	3,040						
	44-46	2,655						
22 Nosler	55	3,500	Crusher Pressures Not Established			550	564	585
22-250 Remington	33	4,350	530	543	563	650	666	691
		4,450						
	40	3,975						
		4,125						
	45	4,000						
	50	3,800						
		4,000						
	52	3,740						
	53-55	3,650						
60	3,500							
	3,600							

1 - Based on sample size $n=10$.

SECTION I – CHARACTERISTICS
 CENTERFIRE RIFLE
 SAAMI VOLUNTARY PERFORMANCE STANDARDS

VELOCITY AND PRESSURE:
 VELOCITY & PRESSURE DATA

Cartridge	Bullet Wt., gr.	Instrumental Velocity, fps	CRUSHER Pressure, CUP/100 ⁽¹⁾			TRANSDUCER Pressure psi/100 ⁽¹⁾		
			MAP	MPLM	MPSM	MAP	MPLM	MPSM
220 Swift	40	4,040	540	554	574	620	636	660
		4,170						
	50	3,840						
	55	3,650						
	60	3,600						
221 Remington Fireball	50	2,975	520	533	553	600	615	638
222 Remington	35	3,760	460	472	489	500	513	532
	40	3,370						
		3,570						
	43	3,400						
	50-52	3,110						
		3,345						
	55	3,000						
222 Remington Magnum	55	3,215	500	513	532	550	564	585

1 - Based on sample size n=10.

SECTION I – CHARACTERISTICS
 CENTERFIRE RIFLE
 SAAMI VOLUNTARY PERFORMANCE STANDARDS

VELOCITY AND PRESSURE:
 VELOCITY & PRESSURE DATA

Cartridge	Bullet Wt., gr.	Instrumental Velocity, fps	CRUSHER Pressure, CUP/100 ⁽¹⁾			TRANSDUCER Pressure psi/100 ⁽¹⁾		
			MAP	MPLM	MPSM	MAP	MPLM	MPSM
223 Remington	35	3,800	520	533	553	550	564	585
		4,000						
	40	3,650						
		3,770						
	42	3,450						
	45	3,550						
	50	3,410						
	53	3,305						
		3,465						
	55	3,050						
		3,215						
	60	3,080						
		3,200						
	62	3,000						
3,080								
64	3,240							
	3,000							
64	3,070							
	69	2,985						
75	2,775							
	2,910							
77	2,670							
	2,785							
223 Winchester Super Short Magnum	55	3,850	Crusher Pressures Not Established			650	666	691
	64	3,600	Crusher Pressures Not Established					
224 Valkyrie	60	3,300	Crusher Pressures Not Established			550	564	585
	75	3,000	Crusher Pressures Not Established					
	80½	2,925	Crusher Pressures Not Established					
	90	2,700	Crusher Pressures Not Established					

1 - Based on sample size η=10.

SECTION I – CHARACTERISTICS
 CENTERFIRE RIFLE
 SAAMI VOLUNTARY PERFORMANCE STANDARDS

VELOCITY AND PRESSURE:
 VELOCITY & PRESSURE DATA

Cartridge	Bullet Wt., gr.	Instrumental Velocity, fps	CRUSHER Pressure, CUP/100 ⁽¹⁾			TRANSDUCER Pressure psi/100 ⁽¹⁾		
			MAP	MPLM	MPSM	MAP	MPLM	MPSM
243 Winchester	55	3,880	520	533	553	600	615	638
	58	3,730						
		3,925						
	70	3,450						
		3,325						
	75	3,580						
		3,325						
	85-87	3,200						
		3,300						
	90	3,110						
		3,050						
	3,175							
	2,850							
	2,950							
100	3,050							
	3,080							
243 Winchester Super Short Magnum	55	4,125	Crusher Pressures Not Established			650	666	691
	95	3,250	Crusher Pressures Not Established			650	666	691
	100	3,110	Crusher Pressures Not Established			650	666	691
25 Winchester Super Short Magnum	85	3,470	Crusher Pressures Not Established			650	666	691
	110	3,090	Crusher Pressures Not Established			650	666	691
	115	3,060	Crusher Pressures Not Established			650	666	691
	120	2,990	Crusher Pressures Not Established			650	666	691

1 - Based on sample size $n=10$.

SECTION I – CHARACTERISTICS
 CENTERFIRE RIFLE
 SAAMI VOLUNTARY PERFORMANCE STANDARDS

VELOCITY AND PRESSURE:
 VELOCITY & PRESSURE DATA

Cartridge	Bullet Wt., gr.	Instrumental Velocity, fps	CRUSHER Pressure, CUP/100 ⁽¹⁾			TRANSDUCER Pressure psi/100 ⁽¹⁾		
			MAP	MPLM	MPSM	MAP	MPLM	MPSM
25-06 Remington	85	3,510	530	543	563	630	646	670
	87	3,420						
	90	3,420						
	100	3,210						
	115	3,100						
	117	2,975						
	120	3,100						
25-20 Winchester	86	1,445	280	287	298	Piezo Pressures Not Established		
25-35 Winchester	117	2,210	370	379	393	Piezo Pressures Not Established		
250 Savage	87	3,010	450	461	478	Piezo Pressures Not Established		
	100	2,800						
257 Roberts	87	3,150	450	461	478	540	554	574
	100	2,880						
	117	2,630						
257 Roberts +P	100	3,150	500	513	532	580	595	617
	117	2,760						
		2,920						
257 Weatherby Magnum	87	3,845	535	549	569	625	641	665
	100	3,580						
	120	3,335						
26 Nosler	129	3,400	Crusher Pressures Not Established			650	666	691
260 Remington	120	2,880	Crusher Pressures Not Established			600	615	638
	130	2,830						
	140	2,725						
264 Winchester Magnum	100	3,300	540	554	574	640	656	680
	140	3,015						
27 Nosler	150	3,200	Crusher Pressures Not Established			650	666	691

1 - Based on sample size $n=10$.

SECTION I – CHARACTERISTICS
 CENTERFIRE RIFLE
 SAAMI VOLUNTARY PERFORMANCE STANDARDS

VELOCITY AND PRESSURE:
 VELOCITY & PRESSURE DATA

Cartridge	Bullet Wt., gr.	Instrumental Velocity, fps	CRUSHER Pressure, CUP/100 ⁽¹⁾			TRANSDUCER Pressure psi/100 ⁽¹⁾		
			MAP	MPLM	MPSM	MAP	MPLM	MPSM
270 Weatherby Magnum	100	3,745	535	549	569	625	641	665
	130	3,350						
	150	3,220						
270 Winchester	100	3,300	520	533	553	650	666	691
	115	2,645						
	130	3,050						
		3,130						
	135	3,200						
		2,990						
	140	2,950						
		3,090						
	150	2,830						
		2,925						
2,950								
160	3,000							
270 Winchester Short Magnum	130	3,275	Crusher Pressures Not Established			650	666	691
	140	3,125						
	150	3,150						
277 Sig Fury ⁽²⁾	135	3,000 ⁽²⁾	Crusher Pressures Not Established			800 ⁽³⁾	820	850
28 Nosler	168	3,125	Crusher Pressures Not Established			650	666	691
280 Ackley Improved	140	3,260	Crusher Pressures Not Established			650	666	691
	155	2,930						
	168	2,830						

1 - Based on sample size $n=10$.

2 – Based on 16" test barrel.

3 – **WARNING:** Maximum Average Pressure levels greater than 65,000 psi may present increased risk of unsafe cartridge case or firearm rupture and thus require cartridge case and/or firearm designs that depart from traditional practices (materials, construction, and other design criteria).

SECTION I – CHARACTERISTICS
 CENTERFIRE RIFLE
 SAAMI VOLUNTARY PERFORMANCE STANDARDS

VELOCITY AND PRESSURE:
 VELOCITY & PRESSURE DATA

Cartridge	Bullet Wt., gr.	Instrumental Velocity, fps	CRUSHER Pressure, CUP/100 ⁽¹⁾			TRANSDUCER Pressure psi/100 ⁽¹⁾		
			MAP	MPLM	MPSM	MAP	MPLM	MPSM
280 Remington	120	3,135	500	513	532	600	615	638
	139	3,100						
	140	2,985						
	150	2,875						
		2,975						
	165	2,800						
284 Winchester	125	3,125	540	554	574	560	574	595
	150	2,845						
30 Carbine ⁽²⁾	110	1,965	400	410	425	400	410	425
30 Nosler	210	2,950	Crusher Pressures Not Established			650	666	691
30 Remington AR	125	2,775	Crusher Pressures Not Established			550	564	585
30 Thompson Center	150	2,985	Crusher Pressures Not Established			620	636	660
	165	2,835						
30-06 Springfield	55 (saboted)	4,050	500	513	532	600	615	638
	110	3,300						
	125	2,645						
		3,125						
		2,740						
	150	2,900						
		2,960						
		3,065						
		3,080						
	165	3,015						
	165-168	2,790						
		2,690						
	180	2,750						
2,860								
200	2,540							
220	2,400							

1 - Based on sample size $n=10$.

2 - Based on 20" test barrel.

SECTION I – CHARACTERISTICS
 CENTERFIRE RIFLE
 SAAMI VOLUNTARY PERFORMANCE STANDARDS

VELOCITY AND PRESSURE:
 VELOCITY & PRESSURE DATA

Cartridge	Bullet Wt., gr.	Instrumental Velocity, fps	CRUSHER Pressure, CUP/100 ⁽¹⁾			TRANSDUCER Pressure psi/100 ⁽¹⁾		
			MAP	MPLM	MPSM	MAP	MPLM	MPSM
30-30 Winchester	55 (saboted)	3,365	380	390	404	420	431	447
	125	2,155						
		2,550						
	140	2,500						
	150	2,370						
		2,440						
	160	2,285						
		2,380						
	170	2,180						
	175	1,050						
30-40 Krag	180	2,420	400	410	425	Piezo Pressures Not Established		
	220	2,150						
300 AAC BLACKOUT ⁽²⁾	90	2,500	Crusher Pressures Not Established			550	564	585
	115	2,270						
	120	2,100						
	123	2,280						
	125	2,185						
	150	1,900						
	190	1,040						
220	1,020							
300 HAM'R ⁽²⁾	125	2,450	Crusher Pressures Not Established			575	590	612
	130	2,425						
300 Holland & Holland Magnum	150	3,110	540	554	574	580	595	617
	180	2,870						
	220	2,565						
300 Norma Magnum	215	2,970	Crusher Pressures Not Established			610	625	648
	230	2,870						
300 Precision Rifle Cartridge	200	2,810	Crusher Pressures Not Established			650	666	691
	225	2,800						

1 - Based on sample size n=10.

2 - Based on test 16" barrel.

SECTION I – CHARACTERISTICS
 CENTERFIRE RIFLE
 SAAMI VOLUNTARY PERFORMANCE STANDARDS

VELOCITY AND PRESSURE:
 VELOCITY & PRESSURE DATA

Cartridge	Bullet Wt., gr.	Instrumental Velocity, fps	CRUSHER Pressure, CUP/100 ⁽¹⁾			TRANSDUCER Pressure psi/100 ⁽¹⁾		
			MAP	MPLM	MPSM	MAP	MPLM	MPSM
300 Remington Short Action Ultra Magnum	150	3,275	Crusher Pressures Not Established			650	666	691
	165	3,125						
	180	3,150						
300 Remington Ultra Magnum	150	2,910	Crusher Pressures Not Established			650	666	691
		3,440						
	165	3,200						
		3,350						
	180	2,960						
		3,225						
		3,095						
	3,025							
	220	2,900						
300 Ruger Compact Magnum	150	3,280	Crusher Pressures Not Established			650	666	691
	165	3,120						
	180	2,980						
300 Savage	150	2,615	460	472	489	470	482	500
		2,740						
	180	2,340						
300 Weatherby Magnum	165	3,140	Crusher Pressures Not Established			650	666	691
	180	3,125						
	190	2,955						
	220	2,775						

1 - Based on sample size $n=10$.

SECTION I – CHARACTERISTICS
 CENTERFIRE RIFLE
 SAAMI VOLUNTARY PERFORMANCE STANDARDS

VELOCITY AND PRESSURE:
 VELOCITY & PRESSURE DATA

Cartridge	Bullet Wt., gr.	Instrumental Velocity, fps	CRUSHER Pressure, CUP/100 ⁽¹⁾			TRANSDUCER Pressure psi/100 ⁽¹⁾		
			MAP	MPLM	MPSM	MAP	MPLM	MPSM
300 Winchester Magnum	150	2,635	540	554	574	640	656	680
		3,150						
		3,275						
	165	3,390						
		3,120						
		3,260						
	180	2,950						
		3,040						
		3,080						
	190	2,875						
2,700								
200	2,800							
	2,930							
220	2,665							
300 Winchester Short Magnum	150	3,300	Crusher Pressures Not Established			650	666	691
	165	3,120						
	180	2,970						
	200	2,810						
303 British	150	2,685	450	461	478	490	502	521
		2,820						
	174	2,500						
	180	2,450						
215	2,155							
307 Winchester	150	2,705	520	533	553	Piezo Pressures Not Established		
	180	2,450						
308 Marlin Express	140	2,800	Crusher Pressures Not Established			475	487	505
	160	2,645						

1 - Based on sample size n=10.

SECTION I – CHARACTERISTICS
 CENTERFIRE RIFLE
 SAAMI VOLUNTARY PERFORMANCE STANDARDS

VELOCITY AND PRESSURE:
 VELOCITY & PRESSURE DATA

Cartridge	Bullet Wt., gr.	Instrumental Velocity, fps	CRUSHER Pressure, CUP/100 ⁽¹⁾			TRANSDUCER Pressure psi/100 ⁽¹⁾		
			MAP	MPLM	MPSM	MAP	MPLM	MPSM
308 Winchester	55 (saboted)	3,750	520	533	553	620	636	660
	110	3,150						
	120	3,100						
	125	2,645						
		3,030						
	130	2,790						
		2,800						
	150	2,900						
		2,980						
	165	2,870						
		2,880						
165-168	2,670							
175	2,600							
180	2,600							
200	2,440							
32 Winchester Special	165	2,410	380	390	404	420	431	447
	170	2,235						
32-20 Winchester	100	1,200	160	164	170	Piezo Pressures Not Established		
325 Winchester Short Magnum	180	3,050	Crusher Pressures Not Established			650	666	691
	200	2,940						
	220	2,830						
33 Nosler	250	2,850	Crusher Pressures Not Established			650	666	691
338 Federal	180	2,830	Crusher Pressures Not Established			620	636	660
	185	2,750						
	200	2,630						
	210	2,630						

1 - Based on sample size $n=10$.

SECTION I – CHARACTERISTICS
 CENTERFIRE RIFLE
 SAAMI VOLUNTARY PERFORMANCE STANDARDS

VELOCITY AND PRESSURE:
 VELOCITY & PRESSURE DATA

Cartridge	Bullet Wt., gr.	Instrumental Velocity, fps	CRUSHER Pressure, CUP/100 ⁽¹⁾			TRANSDUCER Pressure psi/100 ⁽¹⁾		
			MAP	MPLM	MPSM	MAP	MPLM	MPSM
338 Lapua Magnum	250	2,950	Crusher Pressures Not Established			650	666	691
	280	2,600						
	285	2,745						
	300	2,620						
338 Marlin Express	200	2,550	Crusher Pressures Not Established			460	472	489
338 Norma Magnum	300	2,670	Crusher Pressures Not Established			625	641	665
338 Remington Ultra Magnum	250	2,850	Crusher Pressures Not Established			650	666	691
	185	2,970						
	200	2,940						
338 Ruger Compact Magnum	225	2,760	Crusher Pressures Not Established			650	666	691
	225	2,800						
338 Weatherby Rebrated Precision Magnum	225	2,800	Crusher Pressures Not Established			650	666	691
338 Winchester Magnum	185	3,075	540	554	574	640	656	680
	200	2,940						
	210	2,855						
	225	2,770						
	225	2,950						
	230	2,750						
	250	2,645						
300	2,800							
340 Weatherby Magnum	200	3,210	535	549	5569	625	641	665
	210	3,200						
	225	2,860						
	250	2,950						
348 Winchester	200	2,505	400	410	425	450	461	478
35 Remington	150	2,275	350	359	372	335	343	356
	200	2,055						
	200	2,200						

1 - Based on sample size n=10.

SECTION I – CHARACTERISTICS
 CENTERFIRE RIFLE
 SAAMI VOLUNTARY PERFORMANCE STANDARDS

VELOCITY AND PRESSURE:
 VELOCITY & PRESSURE DATA

Cartridge	Bullet Wt., gr.	Instrumental Velocity, fps	CRUSHER Pressure, CUP/100 ⁽¹⁾			TRANSDUCER Pressure psi/100 ⁽¹⁾		
			MAP	MPLM	MPSM	MAP	MPLM	MPSM
35 Whelen	180	2,900	520	533	553	620	636	660
	200	2,660						
		2,800						
	225	2,600						
	250	2,385						
350 Legend ⁽²⁾	124	2,470	Crusher Pressures Not Established			550	564	585
	145	2,250						
	155	2,200						
	180	1,985						
	255	1,020						
356 Winchester	200	2,370	520	533	553	Piezo Pressures Not Established		
	250	2,075						
358 Winchester	200	2,475	520	533	553	Piezo Pressures Not Established		
	250	2,215						
360 Buckhammer ⁽³⁾	200	2,170	Crusher Pressures Not Established			500	513	532
370 Sako Magnum	286	2,450	Crusher Pressures Not Established			475	487	505
		2,550						
375 Holland & Holland Magnum	250	2,670	530	543	563	620	636	660
		2,890						
	270	2,680						
		2,850						
	300	2,400						
	2,515							
	2,680							
375 Remington Ultra Magnum	270	2,900	Crusher Pressures Not Established			650	666	691
		2,975						
	300	2,750						

1 - Based on sample size η=10.

2 - Based on 16" test barrel.

3 - Based on a 20" test barrel.

SECTION I – CHARACTERISTICS
 CENTERFIRE RIFLE
 SAAMI VOLUNTARY PERFORMANCE STANDARDS

VELOCITY AND PRESSURE:
 VELOCITY & PRESSURE DATA

Cartridge	Bullet Wt., gr.	Instrumental Velocity, fps	CRUSHER Pressure, CUP/100 ⁽¹⁾			TRANSDUCER Pressure psi/100 ⁽¹⁾		
			MAP	MPLM	MPSM	MAP	MPLM	MPSM
375 Ruger	250	2,890	Crusher Pressures Not Established			620	636	660
	270	2,840						
	300	2,660						
375 Winchester	200	2,180	520	533	553	Piezo Pressures Not Established		
	250	1,885						
376 Steyr	270	2,580	Crusher Pressures Not Established			620	636	660
38-40 Winchester	180	1,150	140	144	149	Piezo Pressures Not Established		
38-55 Winchester	255	1,300	300	308	319	Piezo Pressures Not Established		
400 Legend ⁽²⁾	215	2,230	Crusher Pressures Not Established			450	461	478
405 Winchester	300	2,200	Crusher Pressures Not Established			460	472	489
416 Remington Magnum	350	2,525	540	554	574	650	666	691
	400	2,400						
416 Rigby	400	2,370	Crusher Pressures Not Established			520	533	553
416 Ruger	400	2,410	Crusher Pressures Not Established			620	636	660
416 Weatherby Magnum	400	2,655	535	549	569	Piezo Pressures Not Established		
44 Remington Magnum ⁽³⁾	210	1,900	400	410	425	360	369	385
	240	1,740						
	275	1,565						
44-40 Winchester	200	1,175	130	133	138	110	113	117
	225	1,000						
444 Marlin	240	2,320	440	451	468	420	431	447
	265	2,100						
		2,400						

1 - Based on sample size n=10.

2 - Based on 16" test barrel.

3 - Based on 20" test barrel.

SECTION I – CHARACTERISTICS
 CENTERFIRE RIFLE
 SAAMI VOLUNTARY PERFORMANCE STANDARDS

VELOCITY AND PRESSURE:
 VELOCITY & PRESSURE DATA

Cartridge	Bullet Wt., gr.	Instrumental Velocity, fps	CRUSHER Pressure, CUP/100 ⁽¹⁾			TRANSDUCER Pressure psi/100 ⁽¹⁾		
			MAP	MPLM	MPSM	MAP	MPLM	MPSM
45-70 Government	250	2,025	280	287	298	280	287	298
	300	1,830						
	325	1,880						
	375	2,030						
	405	1,150						
		1,320						
		1,600						
450 Bushmaster	250	2,250	Crusher Pressures Not Established			385	395	410
	260	2,150						
	300	1,900						
	395	1,050						
450 Marlin	325	2,175	Crusher Pressures Not Established			435	446	463
	350	2,125						
458 Lott	465	2,380	Crusher Pressures Not Established			625	641	665
	500	2,150						
		2,300						
458 Winchester Magnum	400	2,250	530	543	563	600	615	638
	450	2,220						
	500	2,025						
		2,240						
	510	2,025						
470 Nitro Express	500	2,150	350	359	372	410	420	436
500 Nitro Express 3"	570	2,125	Crusher Pressures Not Established			385	395	410

1 - Based on sample size $n=10$.

BULLET TYPE ABBREVIATIONS

LEAD:

HPHollow Point
LLead
LHPLead Hollow Point
MPMetal Point

JACKETED:

BTBoat Tail
BTHPBoat Tail Hollow Point
FPFlat Point
FMJFull Metal Jacket
FMCFull Metal Case
HPHollow Point
JFJacketed Frangible
JFPJacketed Flat Point
JHPJacketed Hollow Point
JSPJacketed Soft Point
MCMetal Case
OTMOpen Tip Match
PHPPlated Hollow Point
PSPPointed Soft Point
PTPolymer Tip
SSpitzer
SPSoft Point
XPeXanding Point

SEMI-JACKETED:

SJHPSemi-Jacketed Hollow Point
SJSPSemi-Jacketed Soft Point

OTHER:

HCHard Cast
SolidIndicates a bullet constructed of a single material other than lead.

NOTE: The abbreviations presented here are those which are generic indications of construction features of a projectile. Abbreviations indicative of a specific manufacturer's brand or trademarked name are beyond the scope of this table.

PRIMERS AND PRIMER POCKETS

CUP MAY BE ROUNDED OR FLAT

“SMALL RIFLE” PRIMER

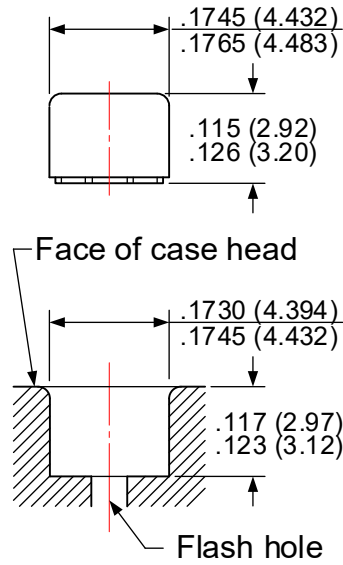

“LARGE RIFLE” PRIMER

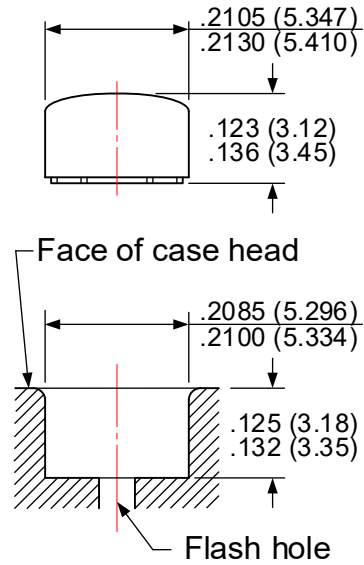

**PRIMERS TO BE SEATED FLUSH TO .008" (.20)
BELOW FACE OF CARTRIDGE CASE HEAD**

NOTE

(XX.XX) = MILLIMETERS

ISSUED: 01/20/2020 **6MM ADVANCED RIFLE CARTRIDGE [6MM ARC]** **REVISED: 11/17/2021**

CARTRIDGE

UNLESS OTHERWISE NOTED
 BODY DIA. -.008 (0.20)

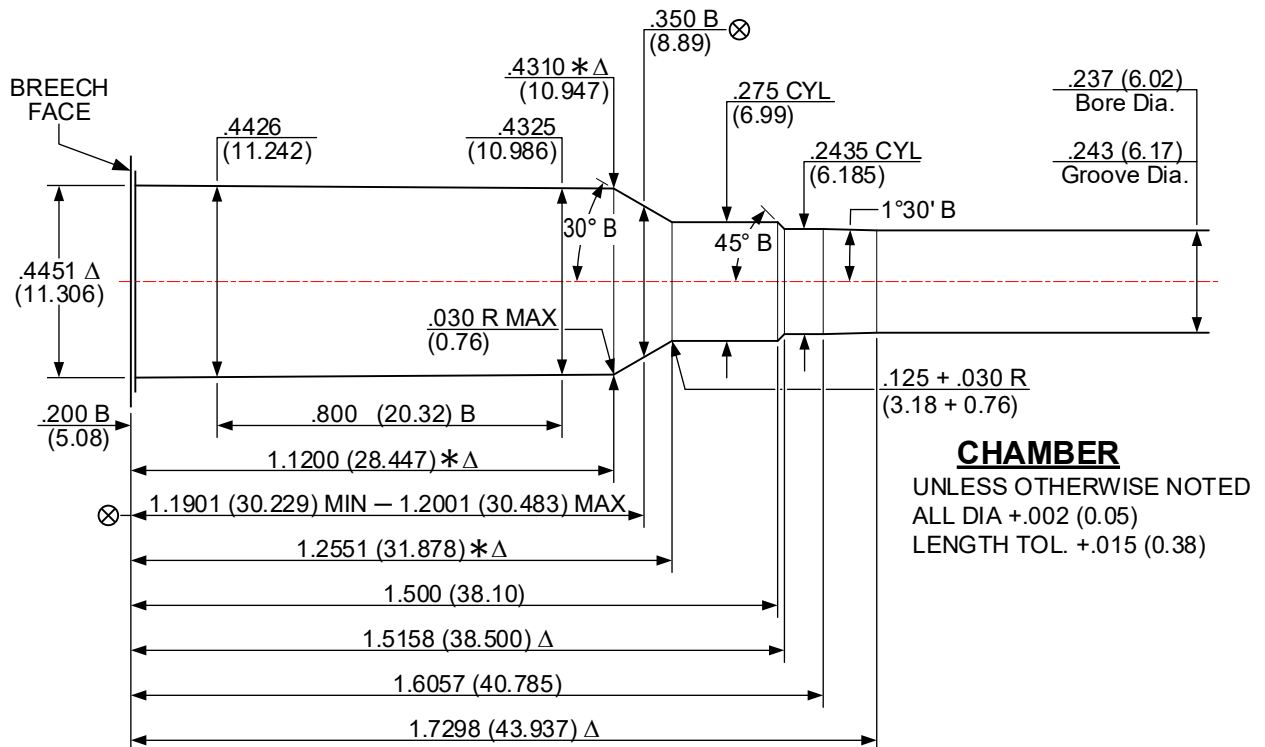
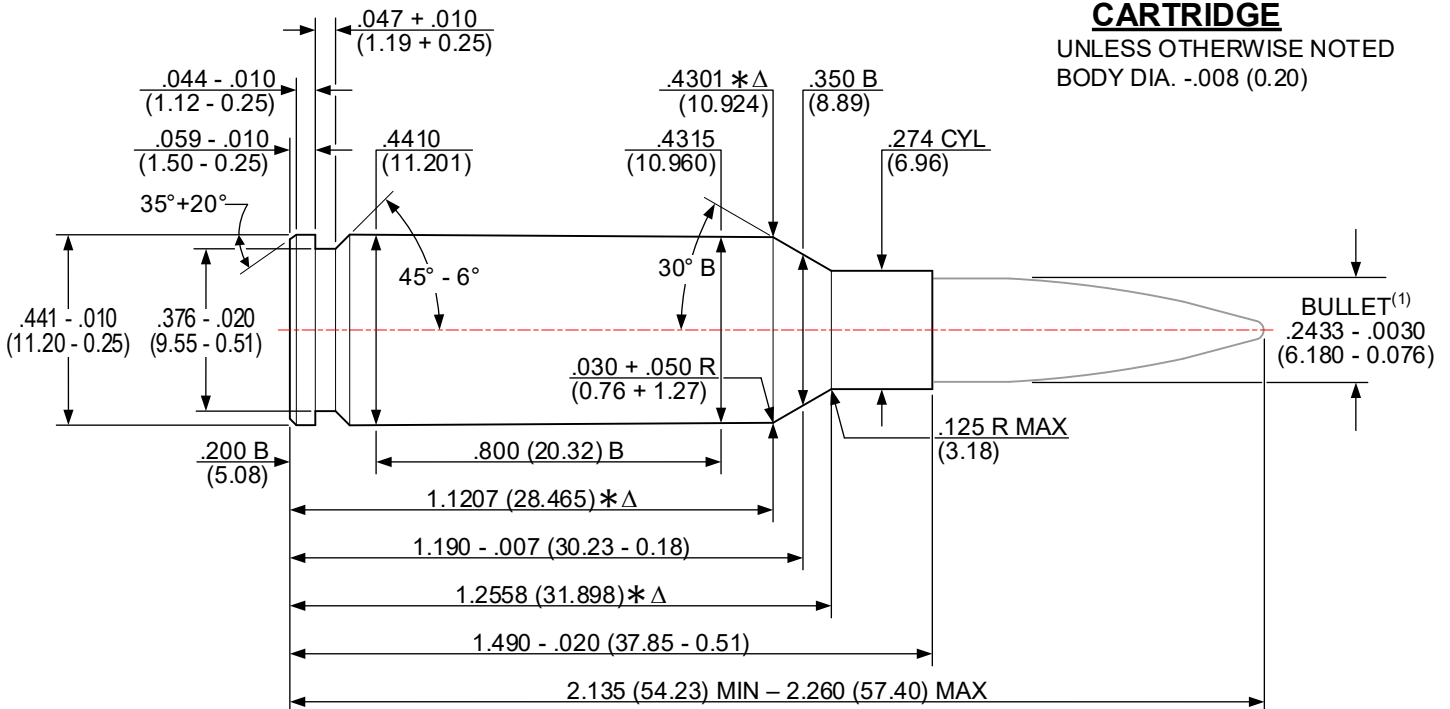

CHAMBER

UNLESS OTHERWISE NOTED
 ALL DIA +.002 (0.05)
 LENGTH TOL. +.015 (0.38)

Δ 6 GROOVES TWIST: 7.50 (190.5) R.H. OPTIONAL
 Δ .090+.002 (2.29+0.05) WIDE MINIMUM BORE & GROOVE AREA: .0457 in² (29.483 mm²)

NOTES:

- B = BASIC (XX.XX) = MILLIMETERS ⊗ = HEADSPACE DIMENSION
- Δ = REFERENCE DIMENSION * = DIMENSIONS ARE TO INTERSECTION OF LINES
- ALL CALCULATIONS APPLY AT MAXIMUM MATERIAL CONDITION (MMC)
- (1) – BULLET PROFILE IS SHOWN FOR ILLUSTRATIVE PURPOSES ONLY

DO NOT SCALE FROM DRAWING

NOTICE: This drawing is subject to change.
 Revisions, if applicable, are available at www.saami.org.

ISSUED: 06/14/2017 **6MM CREEDMOOR [6MM CM]** REVISED: 11/17/2021

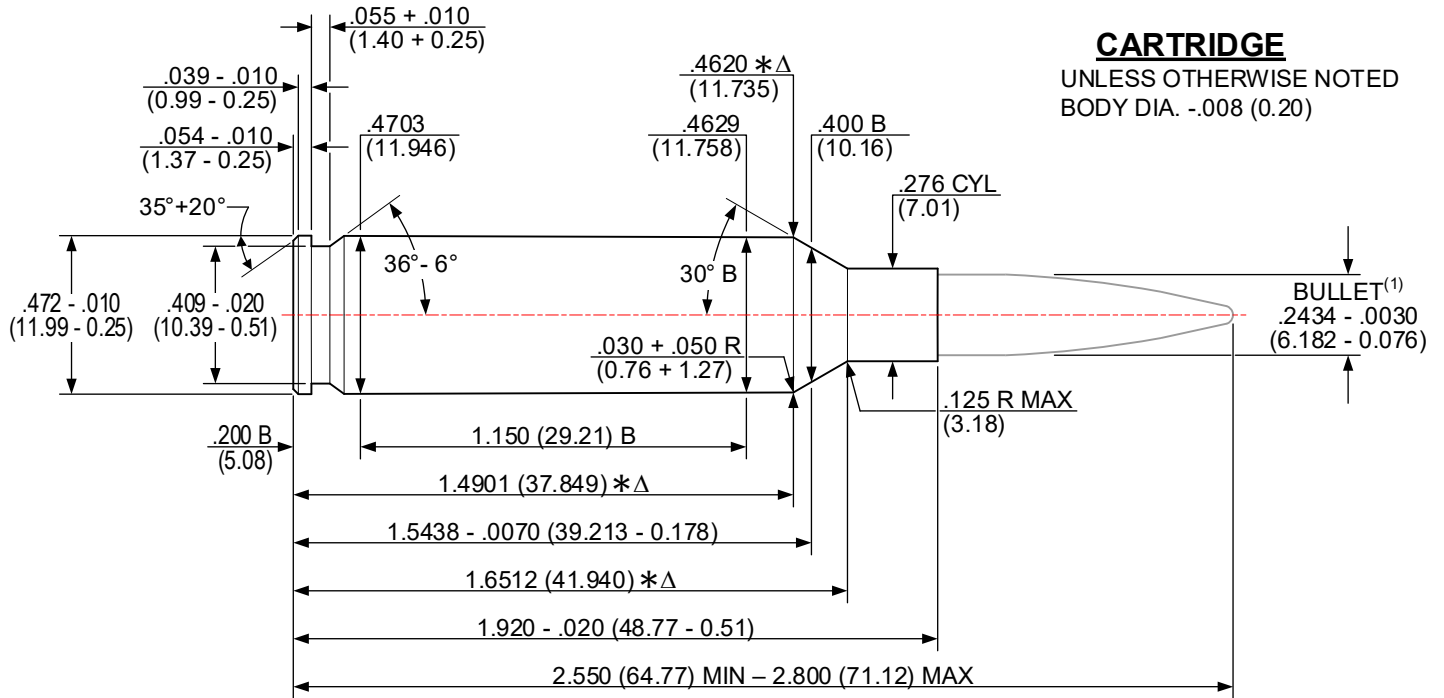

CARTRIDGE
 UNLESS OTHERWISE NOTED
 BODY DIA. -.008 (0.20)

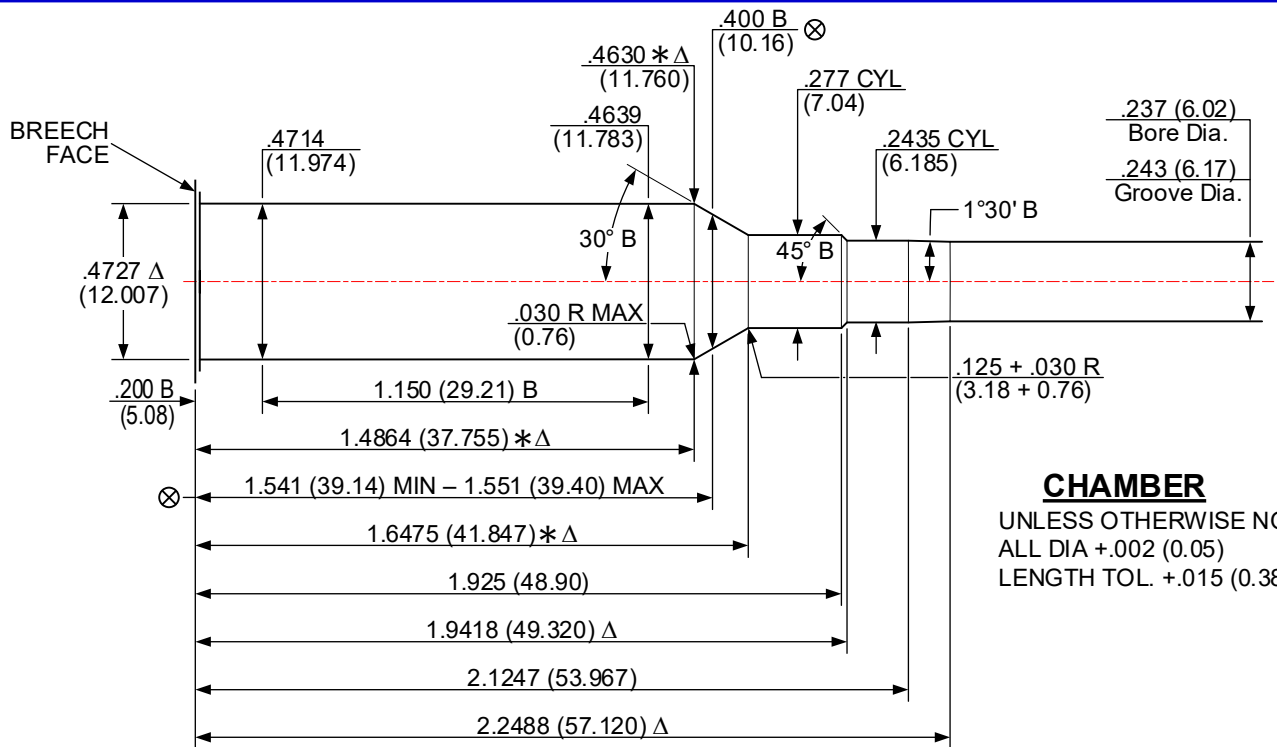

CHAMBER
 UNLESS OTHERWISE NOTED
 ALL DIA +.002 (0.05)
 LENGTH TOL. +.015 (0.38)

Δ 6 GROOVES TWIST: 7.50 (190.5) R.H. OPTIONAL
 Δ .090+.002 (2.29+0.05) WIDE MINIMUM BORE & GROOVE AREA: .0457 in² (29.483 mm²)

NOTES:

- B = BASIC (XX.XX) = MILLIMETERS ⊗ = HEAD SPACE DIMENSION
- Δ = REFERENCE DIMENSION * = DIMENSIONS ARE TO INTERSECTION OF LINES
- ALL CALCULATIONS APPLY AT MAXIMUM MATERIAL CONDITION (MMC)
- (1) – BULLET PROFILE IS SHOWN FOR ILLUSTRATIVE PURPOSES ONLY

DO NOT SCALE FROM DRAWING

NOTICE: This drawing is subject to change.
 Revisions, if applicable, are available at www.saami.org.

ISSUED: 01/16/2022 **6MM GT [6MM GT]** REVISED: -/-/-/-/-

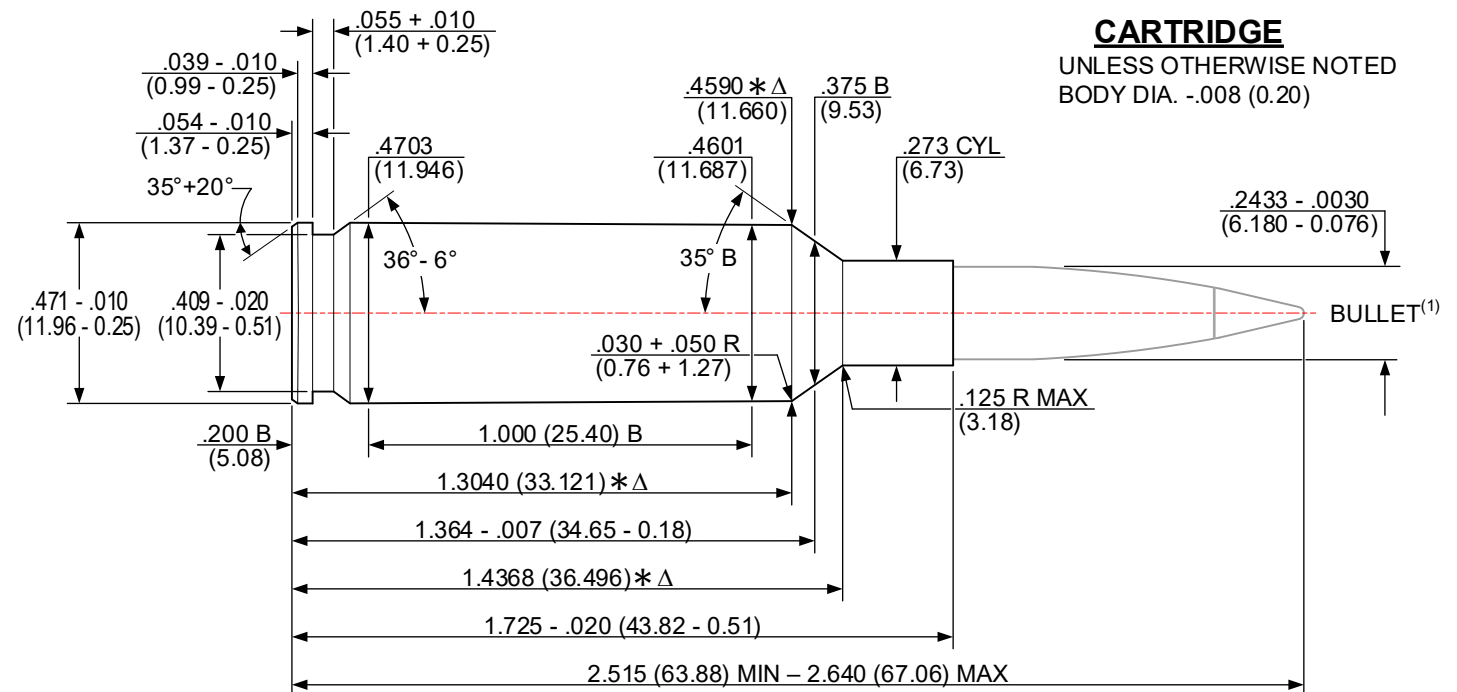

CARTRIDGE
 UNLESS OTHERWISE NOTED
 BODY DIA. -.008 (0.20)

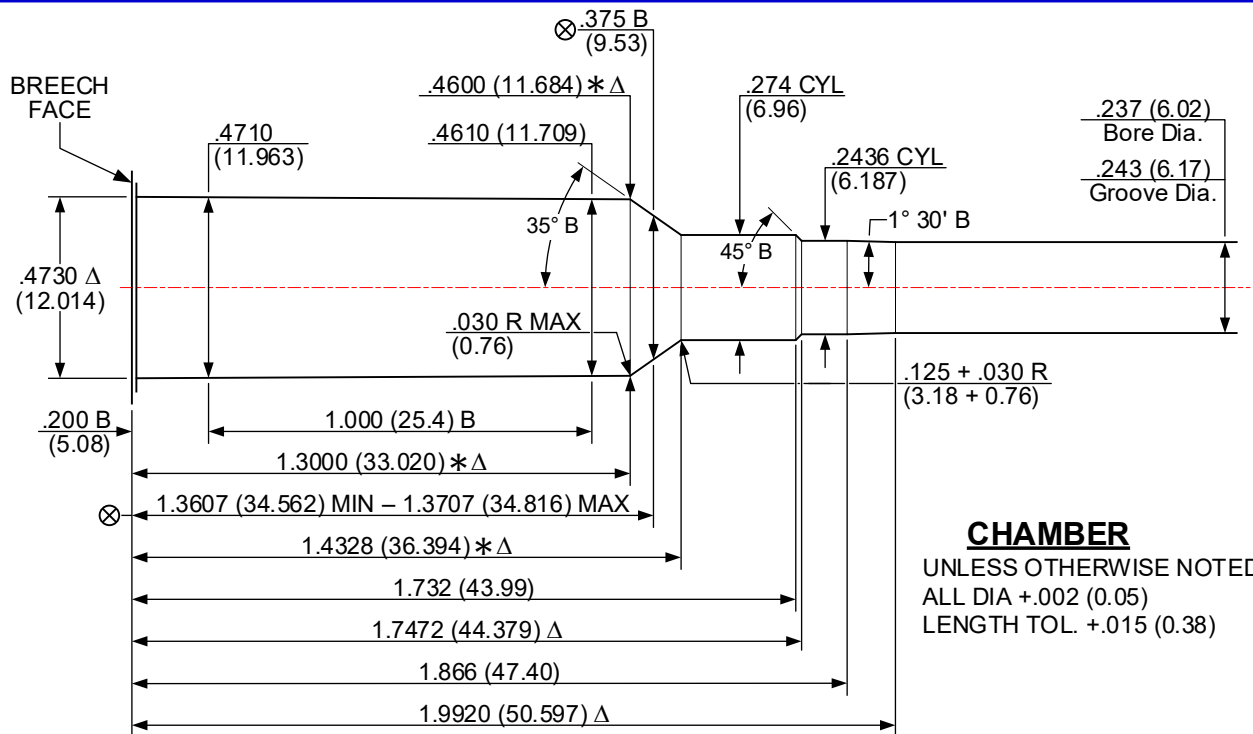

CHAMBER
 UNLESS OTHERWISE NOTED
 ALL DIA +.002 (0.05)
 LENGTH TOL. +.015 (0.38)

Δ 6 GROOVES TWIST: 7.50 (190.5) R.H. OPTIONAL
 Δ .090+.002 (2.29+0.05) WIDE MINIMUM BORE & GROOVE AREA: .0457 in² (29.483 mm²)

NOTES:
 B = BASIC (XX.XX) = MILLIMETERS ⊗ = HEADSPACE DIMENSION
 Δ = REFERENCE DIMENSION * = DIMENSIONS ARE TO INTERSECTION OF LINES
 ALL CALCULATIONS APPLY AT MAXIMUM MATERIAL CONDITION (MMC)
 (1) – BULLET PROFILE IS SHOWN FOR ILLUSTRATIVE PURPOSES ONLY

DO NOT SCALE FROM DRAWING

ISSUED: 05/29/1979 **6MM REMINGTON [6MM REM]** REVISED: 11/17/2021

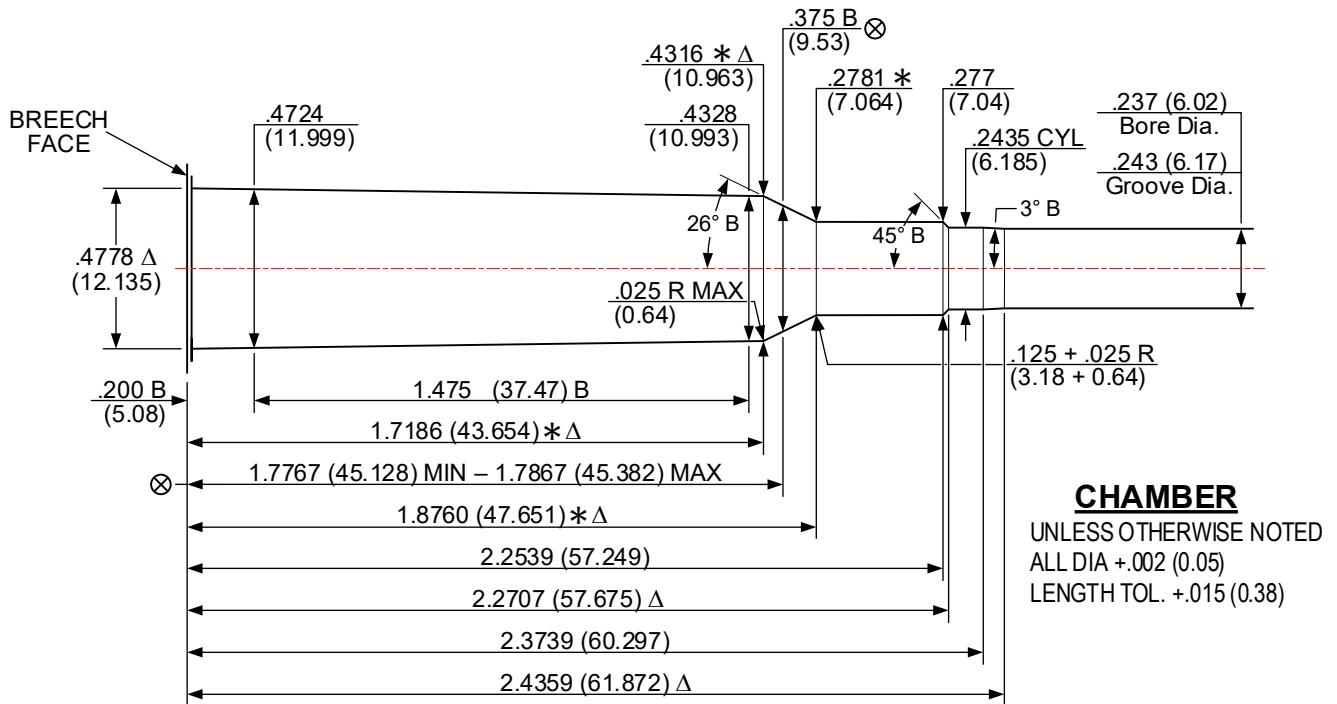
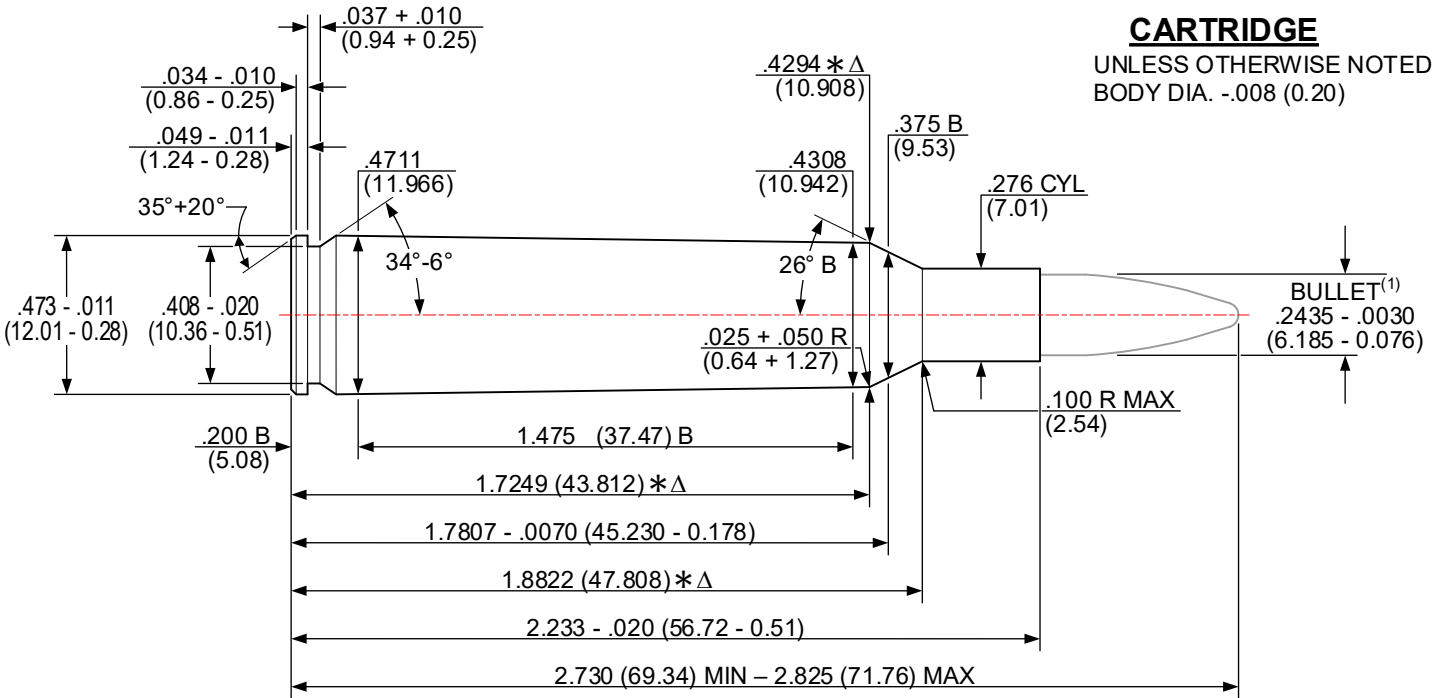

Δ 6 GROOVES TWIST: 9.00 (228.6) R.H. OPTIONAL
 Δ .090+.002 (2.29+0.05) WIDE MINIMUM BORE & GROOVE AREA: .0457 in² (29.483 mm²)

NOTES:
 B = BASIC (XX.XX) = MILLIMETERS ⊗ = HEADSPACE DIMENSION
 Δ = REFERENCE DIMENSION * = DIMENSIONS ARE TO INTERSECTION OF LINES
 ALL CALCULATIONS APPLY AT MAXIMUM MATERIAL CONDITION (MMC)
 (1) – BULLET PROFILE IS SHOWN FOR ILLUSTRATIVE PURPOSES ONLY

DO NOT SCALE FROM DRAWING

ISSUED: 06/17/2009 **6.5 CREEDMOOR [6.5 CM]** REVISED: 11/16/2021

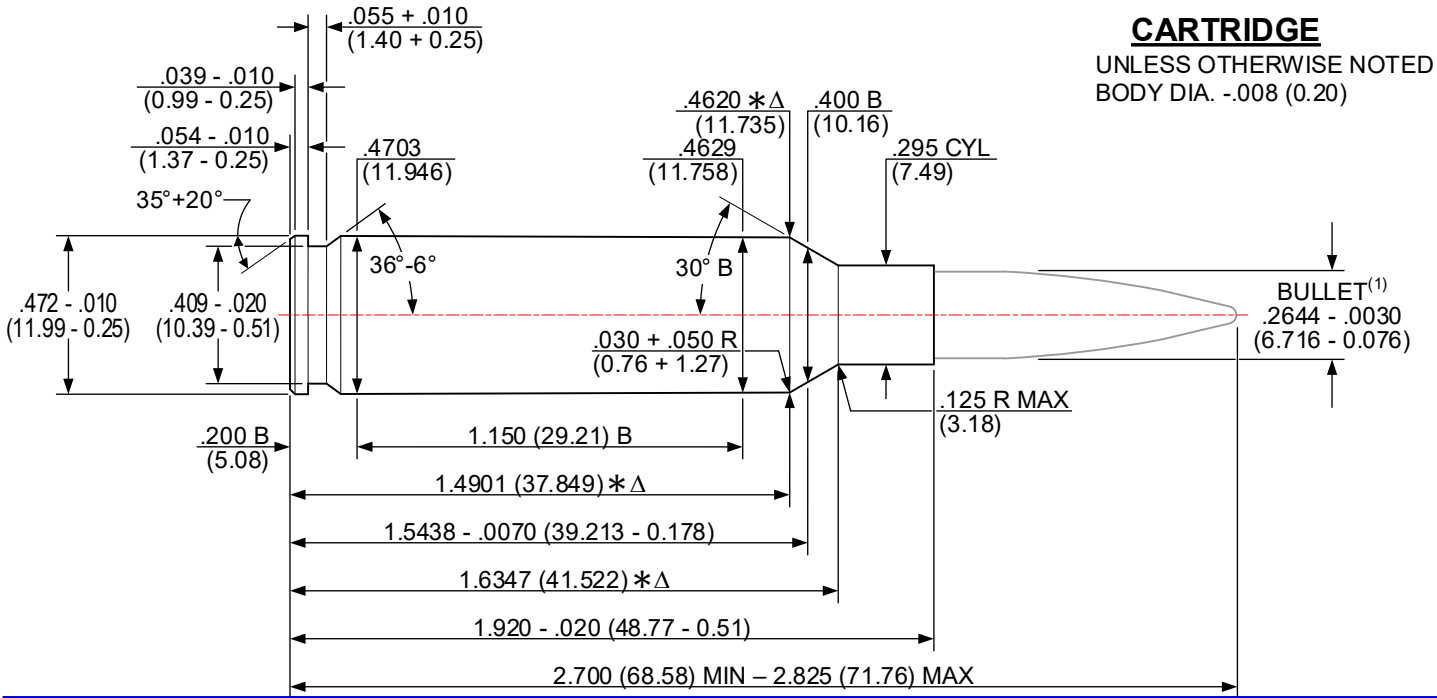

CARTRIDGE
 UNLESS OTHERWISE NOTED
 BODY DIA. -.008 (0.20)

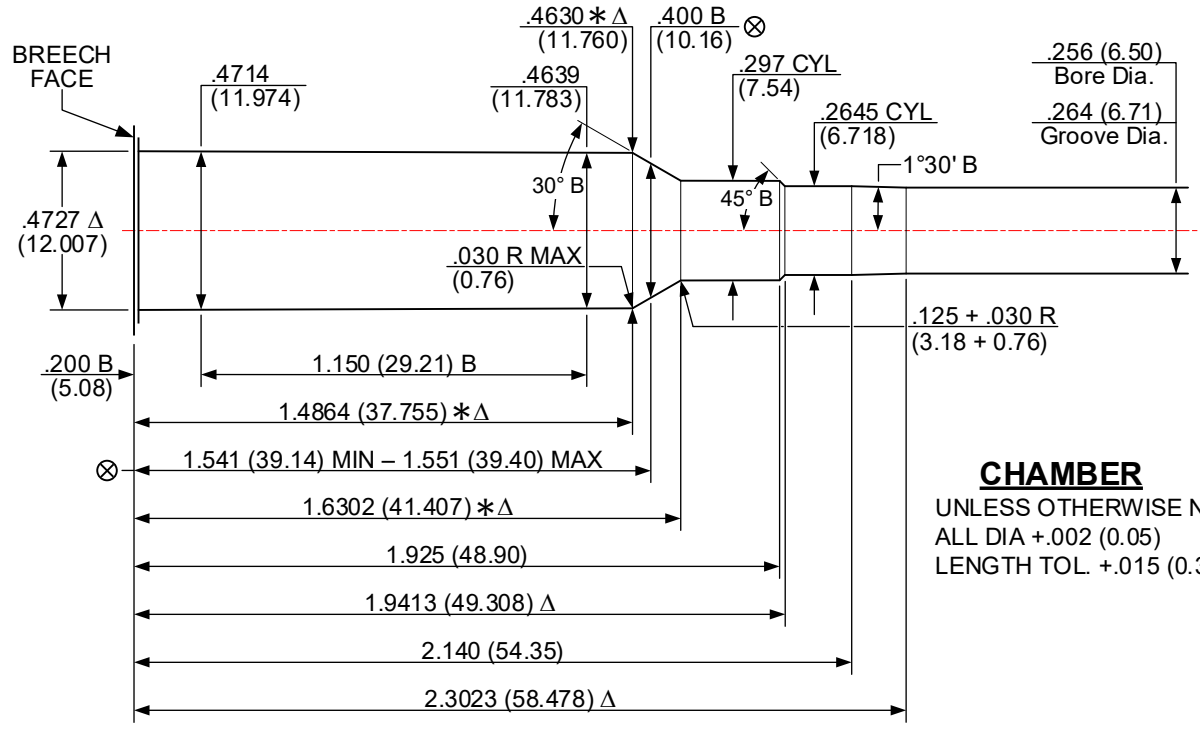

CHAMBER
 UNLESS OTHERWISE NOTED
 ALL DIA +.002 (0.05)
 LENGTH TOL. +.015 (0.38)

Δ 6 GROOVES TWIST: 8.00 (203.2) R.H. OPTIONAL
 Δ .090+.002 (2.29+0.05) WIDE MINIMUM BORE & GROOVE AREA: .0536 in² (34.580 mm²)

NOTES:
 B = BASIC (XX.XX) = MILLIMETERS ⊗ = HEAD SPACE DIMENSION
 Δ = REFERENCE DIMENSION * = DIMENSIONS ARE TO INTERSECTION OF LINES
 ALL CALCULATIONS APPLY AT MAXIMUM MATERIAL CONDITION (MMC)
 (1) – BULLET PROFILE IS SHOWN FOR ILLUSTRATIVE PURPOSES ONLY

DO NOT SCALE FROM DRAWING

NOTICE: This drawing is subject to change.
 Revisions, if applicable, are available at www.saami.org.

ISSUED: 01/17/2011 **6.5 GRENDSEL [6.5 GREN]** REVISED: 11/18/2021

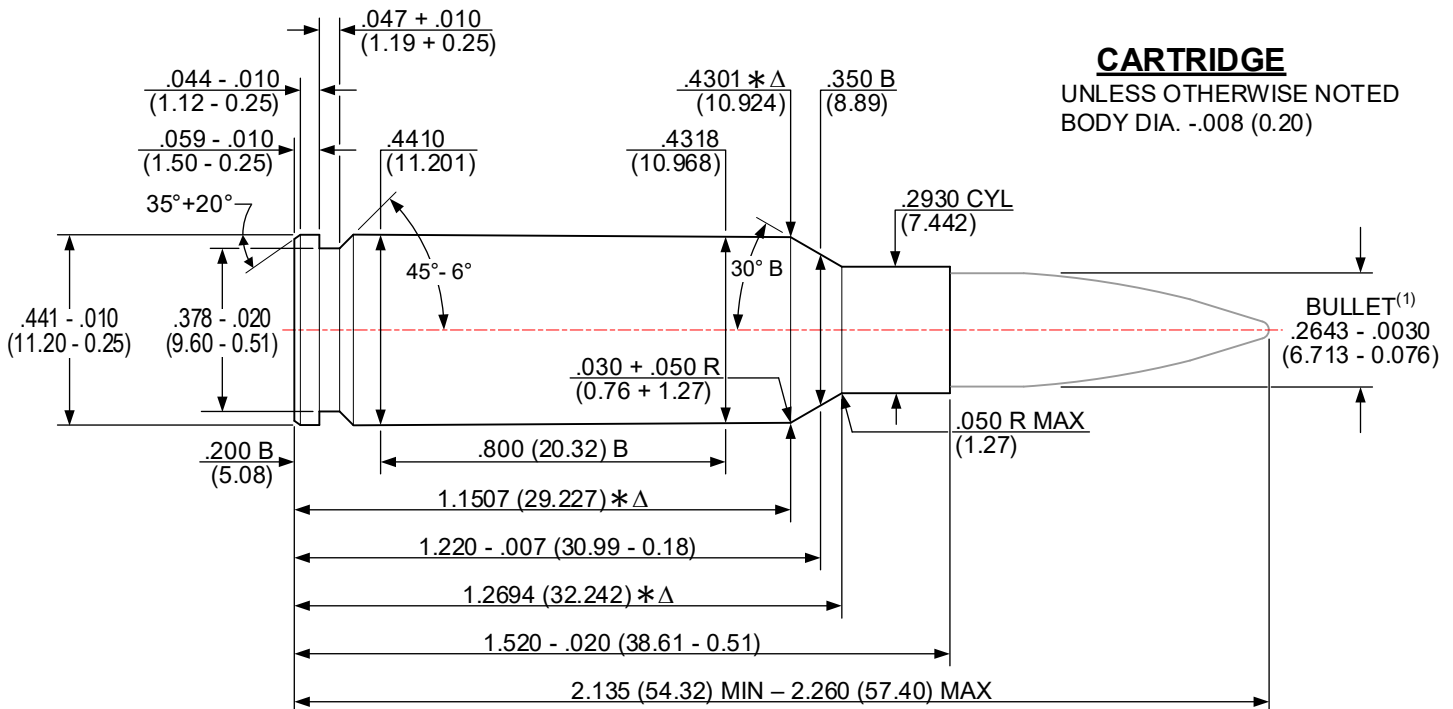

CARTRIDGE
 UNLESS OTHERWISE NOTED
 BODY DIA. -.008 (0.20)

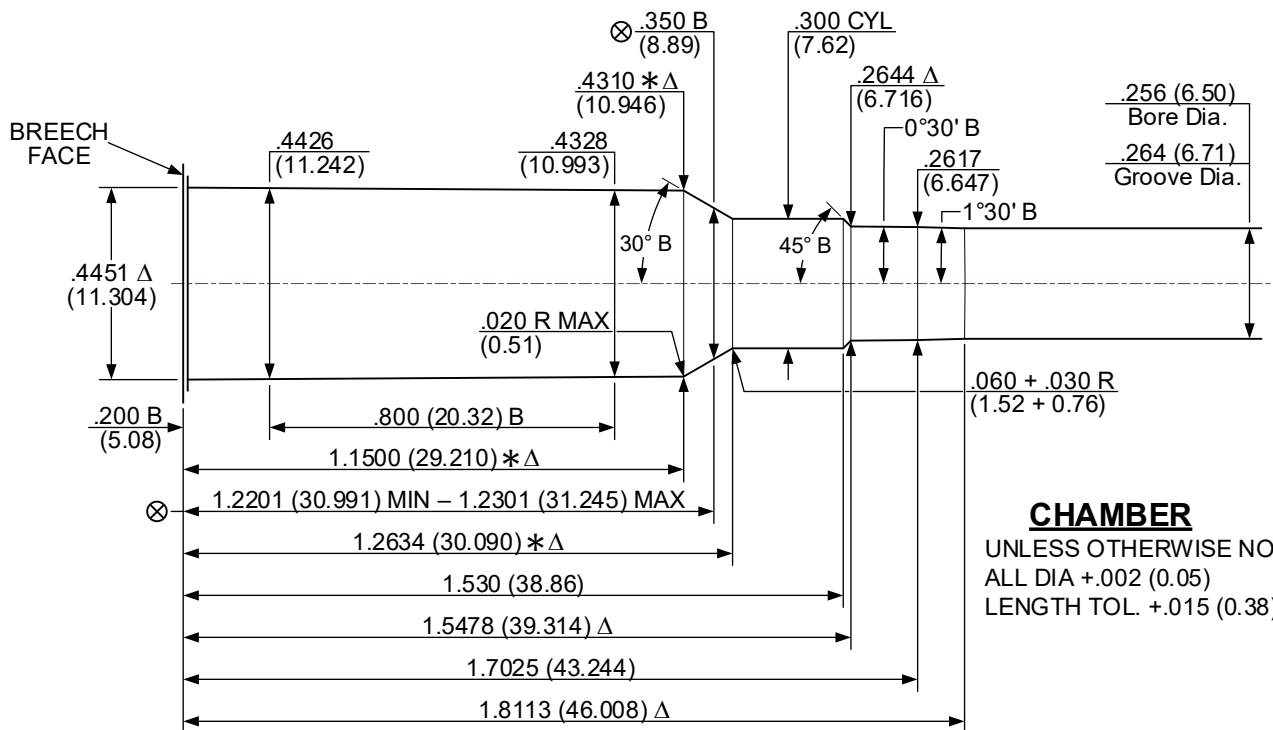

CHAMBER
 UNLESS OTHERWISE NOTED
 ALL DIA +.002 (0.05)
 LENGTH TOL. +.015 (0.38)

Δ 6 GROOVES TWIST: 8.00 (203.2) R.H. OPTIONAL
 Δ .090+.002 (2.29+0.05) WIDE MINIMUM BORE & GROOVE AREA: .0536 in² (34.580 mm²)

NOTES:

- B = BASIC (XX.XX) = MILLIMETERS ⊗ = HEAD SPACE DIMENSION
- Δ = REFERENCE DIMENSION * = DIMENSIONS ARE TO INTERSECTION OF LINES
- ALL CALCULATIONS APPLY AT MAXIMUM MATERIAL CONDITION (MMC)
- (1) – BULLET PROFILE IS SHOWN FOR ILLUSTRATIVE PURPOSES ONLY

DO NOT SCALE FROM DRAWING

NOTICE: This drawing is subject to change.
 Revisions, if applicable, are available at www.saami.org.

6.5 PRECISION RIFLE CARTRIDGE [6.5 PRC]

ISSUED: 06/13/2018

REVISED: 11/18/2021

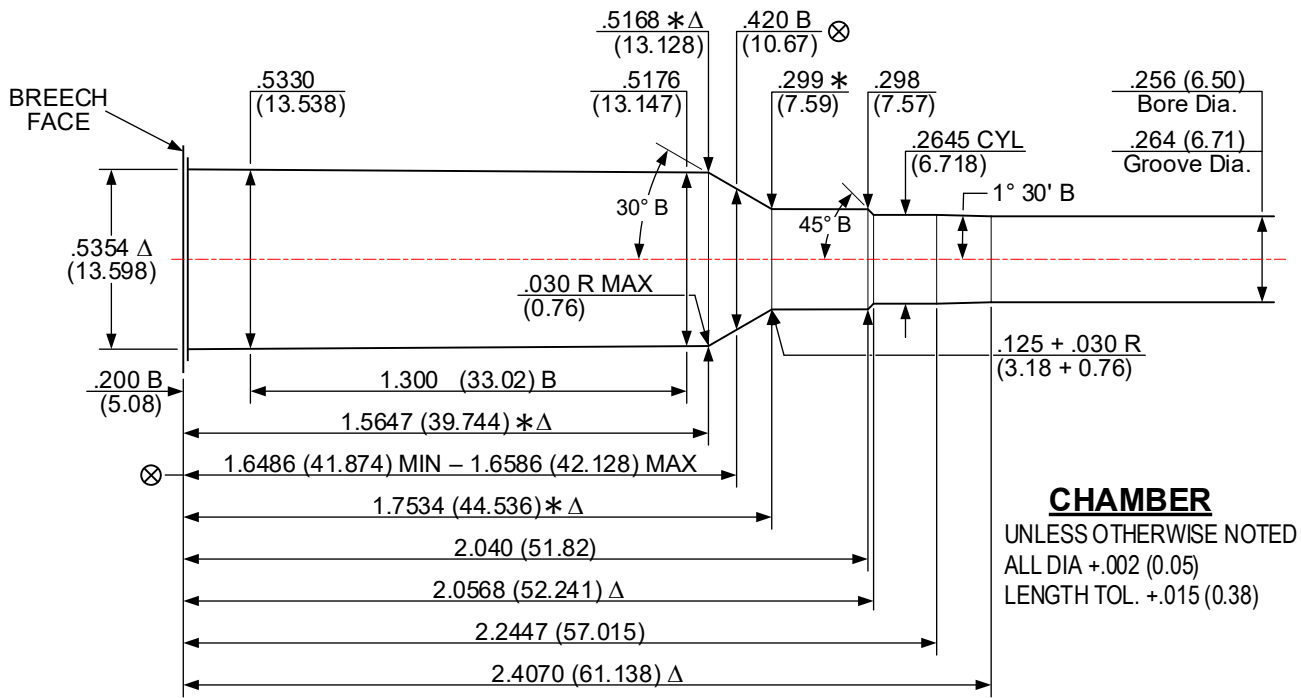
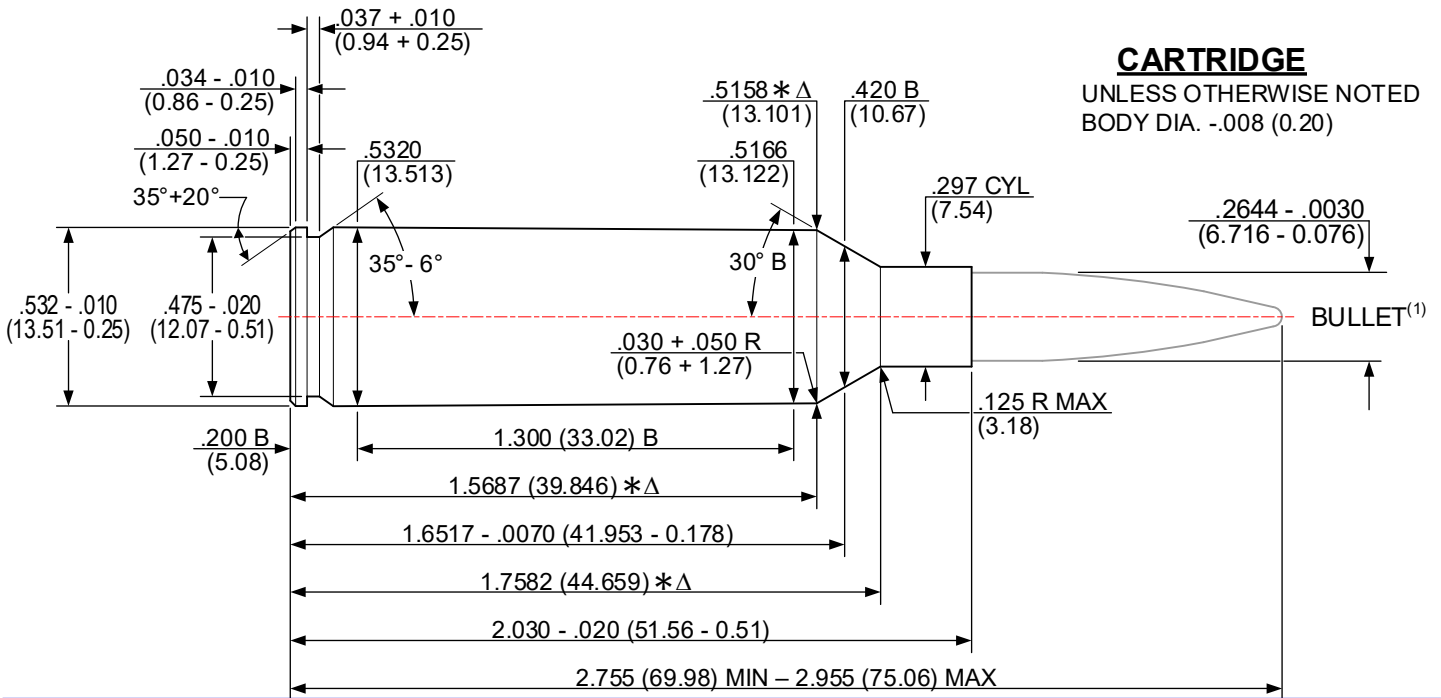

Δ 6 GROOVES TWIST: 8.00 (203.2) R.H. OPTIONAL
 Δ .090+.002 (2.29+0.05) WIDE MINIMUM BORE & GROOVE AREA: .0536 in² (34.580 mm²)

- NOTES:**
 B = BASIC (XX.XX) = MILLIMETERS \otimes = HEADSPACE DIMENSION
 Δ = REFERENCE DIMENSION * = DIMENSIONS ARE TO INTERSECTION OF LINES
 ALL CALCULATIONS APPLY AT MAXIMUM MATERIAL CONDITION (MMC)
 (1) – BULLET PROFILE IS SHOWN FOR ILLUSTRATIVE PURPOSES ONLY

DO NOT SCALE FROM DRAWING

NOTICE: This drawing is subject to change.
 Revisions, if applicable, are available at www.saami.org.

ISSUED: 09/23/2020 **6.5 WEATHERBY REBATED PRECISION MAGNUM [6.5 WBYP RPM]** REVISED: 11/18/2021

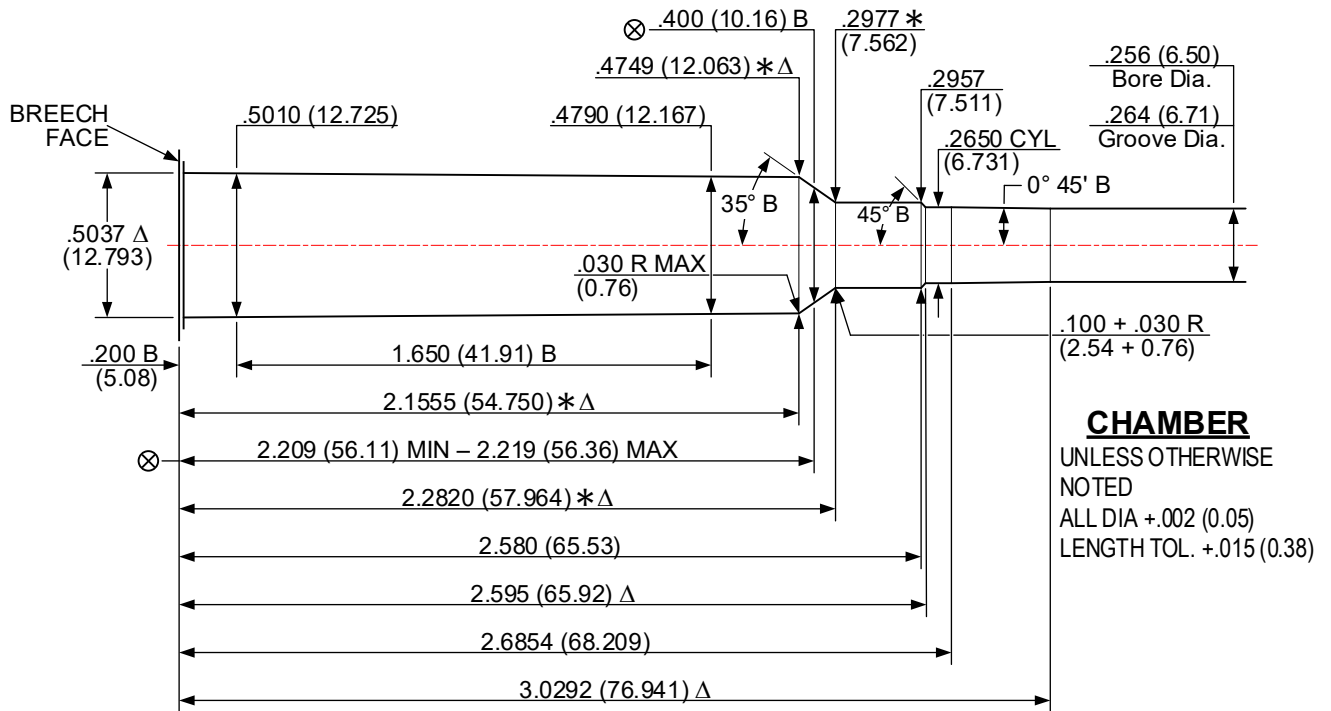
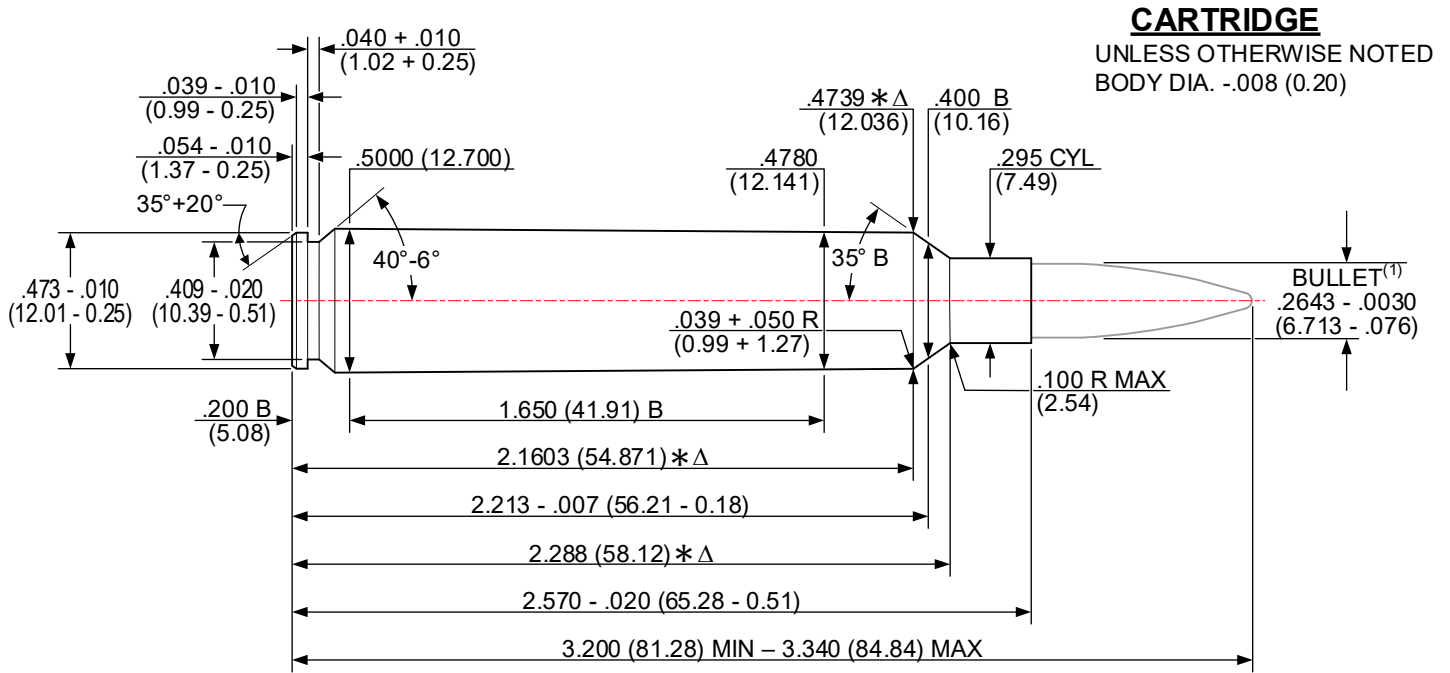

CHAMBER
 UNLESS OTHERWISE
 NOTED
 ALL DIA. +.002 (0.05)
 LENGTH TOL. +.015 (0.38)

Δ 4 GROOVES TWIST: 8.00 (203.2) R.H. OPTIONAL
 Δ .147+.002 (3.73+0.05) WIDE MINIMUM BORE & GROOVE AREA: .0539 in² (34.774 mm²)

NOTES:
 B = BASIC (XX.XXX) = MILLIMETERS ⊗ = HEAD SPACE DIMENSION
 Δ = REFERENCE DIMENSION * = DIMENSIONS ARE TO INTERSECTION OF LINES
 ALL CALCULATIONS APPLY AT MAXIMUM MATERIAL CONDITION (MMC)
 (1) – BULLET PROFILE IS SHOWN FOR ILLUSTRATIVE PURPOSES ONLY

DO NOT SCALE FROM DRAWING

NOTICE: This drawing is subject to change.
 Revisions, if applicable, are available at www.saami.org.

ISSUED: 06/18/2019

6.5-284 NORMA [6.5-284 NORMA]

REVISED: 10/11/2024

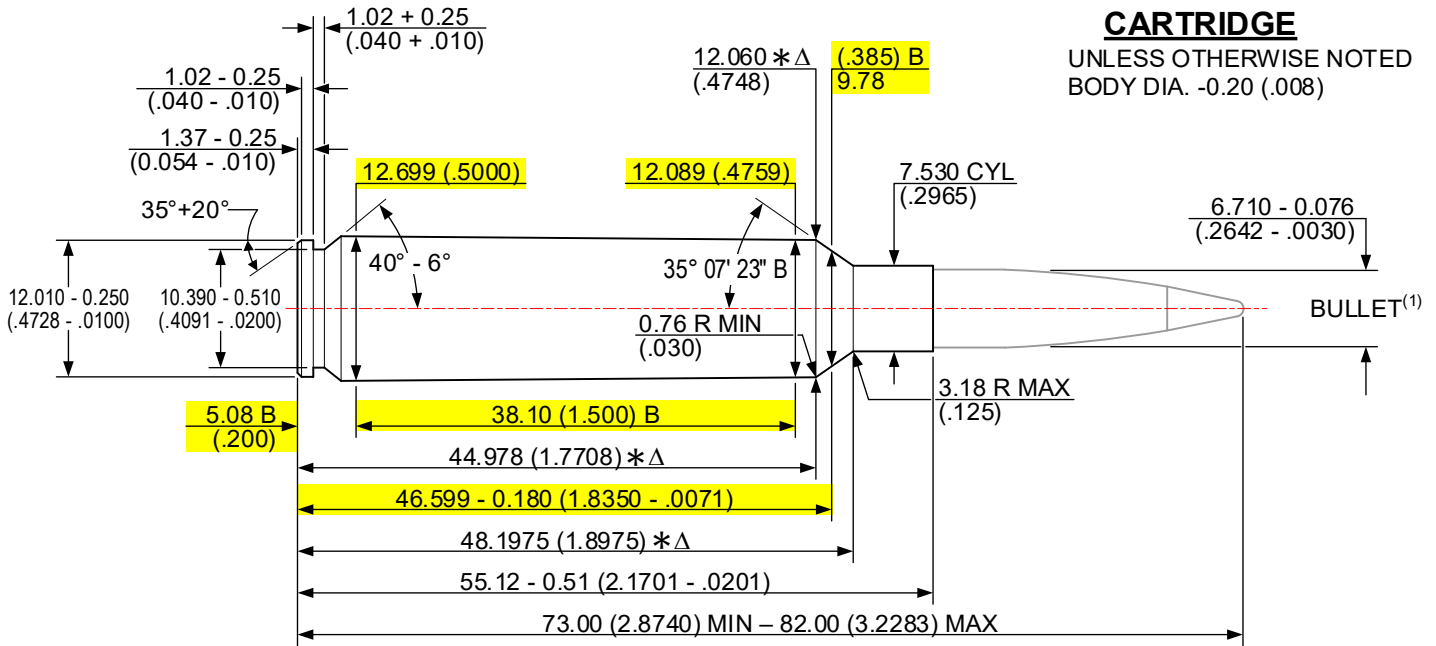

CARTRIDGE
 UNLESS OTHERWISE NOTED
 BODY DIA. -0.20 (.008)

HIGHLIGHTED DIMENSIONS HAVE NO CORRESPONDING C.I.P. ANALOG. THE METRIC UNITS FOR THESE ARE THE ORIGINAL VALUES; U.S. CUSTOMARY VALUES ARE CALCULATED AND ROUNDED.

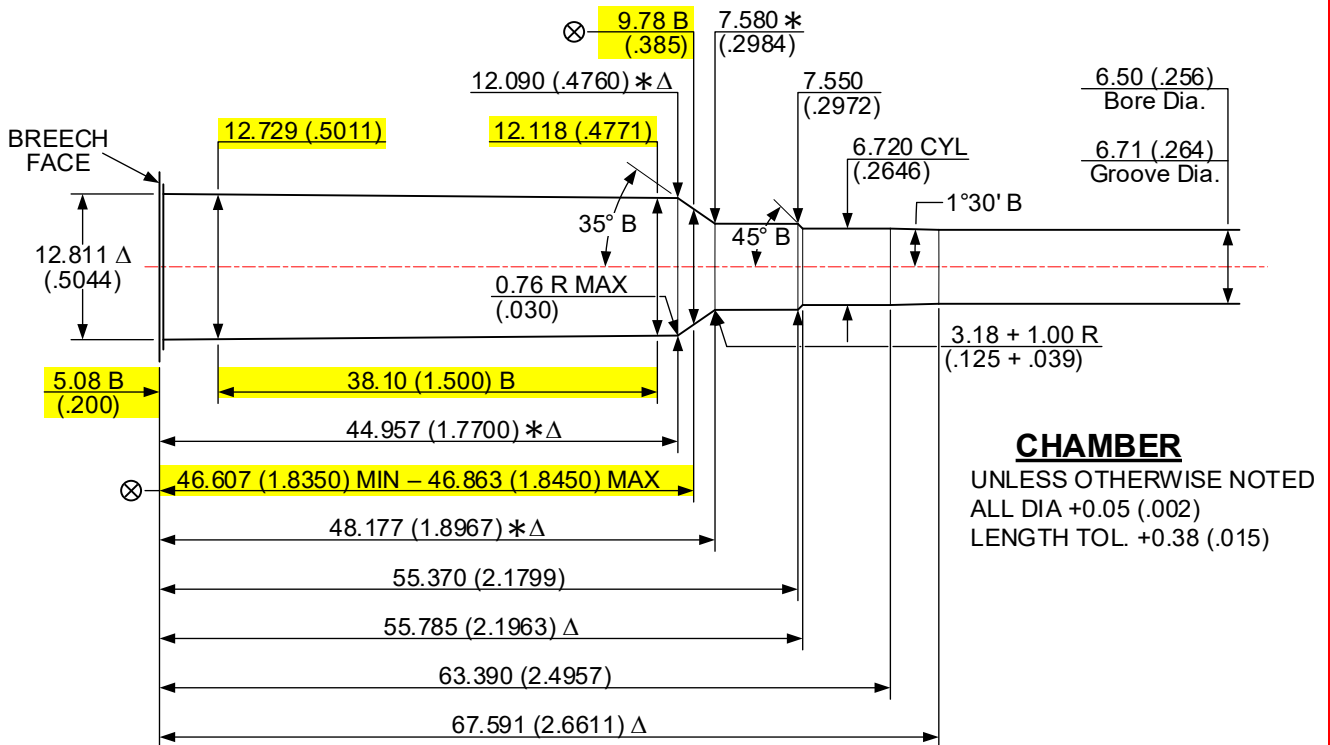

CHAMBER
 UNLESS OTHERWISE NOTED
 ALL DIA +0.05 (.002)
 LENGTH TOL. +0.38 (.015)

Δ 6 GROOVES TWIST: 228.0 (8.98) R.H. OPTIONAL
 Δ 2.290 + 0.050 (.0902 + .0020) WIDE MINIMUM BORE & GROOVE AREA: 34.645 mm² (.0537 in²)

NOTES:
 B = BASIC (XX.XXX) = INCHES ⊗ = HEAD SPACE DIMENSION
 Δ = REFERENCE DIMENSION * = DIMENSIONS ARE TO INTERSECTION OF LINES
 ALL CALCULATIONS APPLY AT MAXIMUM MATERIAL CONDITION (MMC)
 (1) – BULLET PROFILE IS SHOWN FOR ILLUSTRATIVE PURPOSES ONLY

DO NOT SCALE FROM DRAWING

NOTICE: This drawing is subject to change.
 Revisions, if applicable, are available at www.saami.org.

METRIC ORIGIN METRIC ORIGIN METRIC ORIGIN METRIC ORIGIN

ISSUED: 01/16/2017 **6.5-300 WEATHERBY MAGNUM [6.5-300 WB BY MAG]** **REVISED: 01/21/2024**

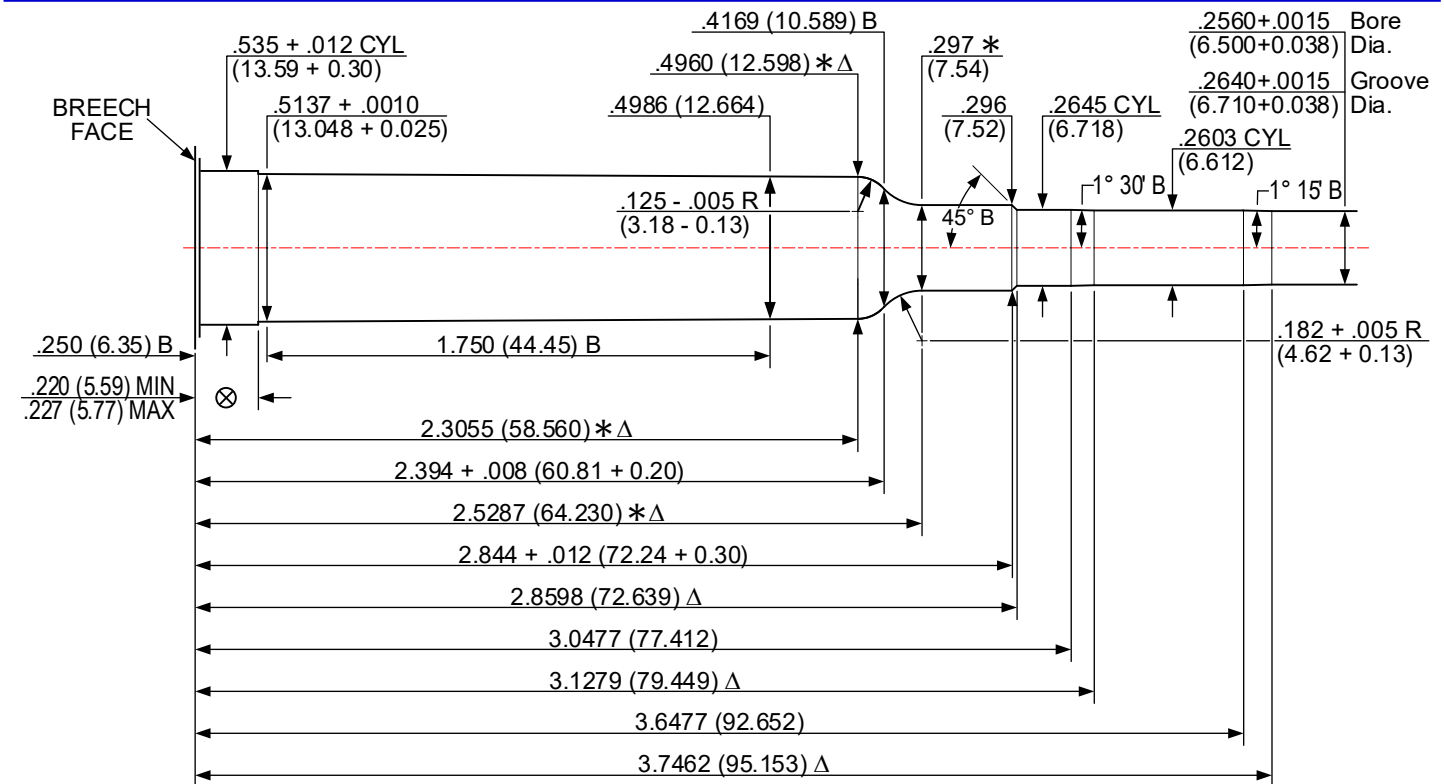
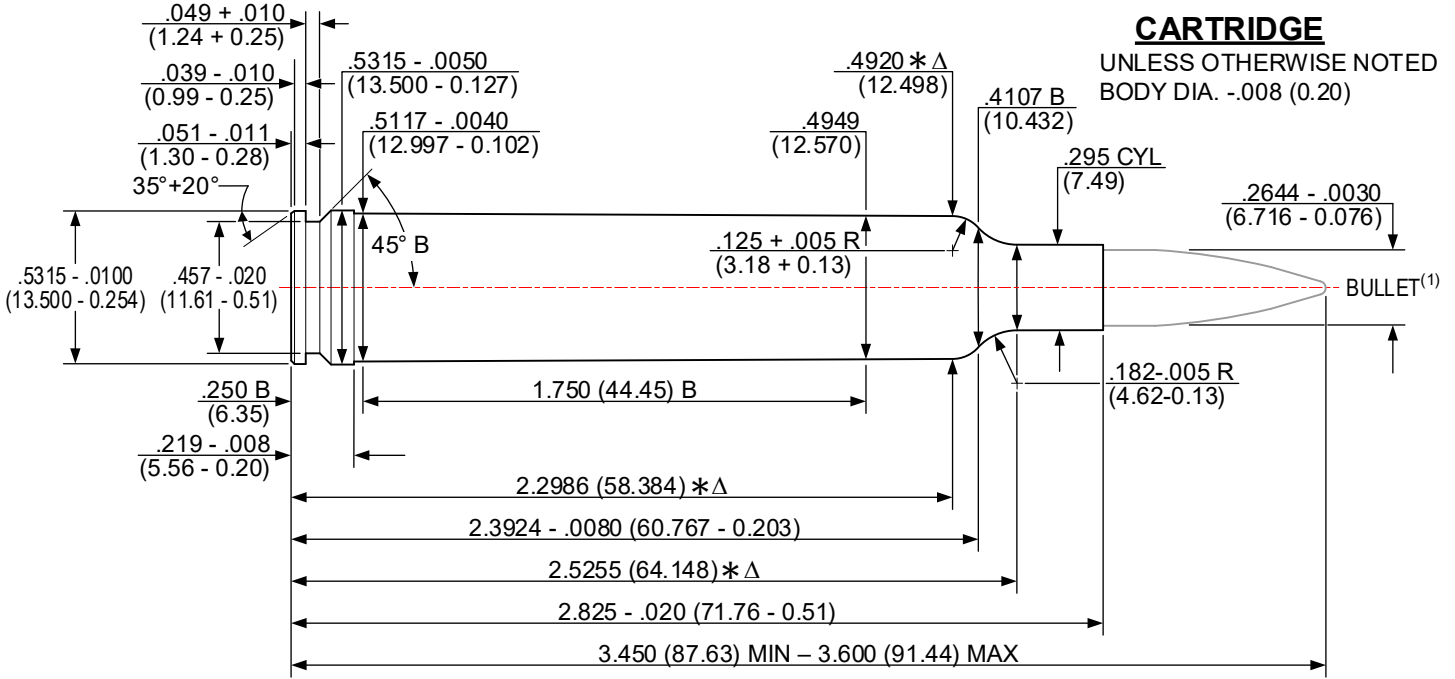

Δ 6 GROOVES
 Δ .095+ .002 (2.41+0.05) WIDE

TWIST: 8.00 (203.2) R.H. OPTIONAL
 MINIMUM BORE & GROOVE AREA: .0538 in² (34.709 mm²)

CHAMBER
 UNLESS OTHERWISE NOTED
 ALL DIA +.002 (0.05)
 LENGTH TOL. +.015 (0.38)

NOTES:

- B = BASIC
- Δ = REFERENCE DIMENSION
- ALL CALCULATIONS APPLY AT MAXIMUM MATERIAL CONDITION (MMC)
- (1) – BULLET PROFILE IS SHOWN FOR ILLUSTRATIVE PURPOSES ONLY
- (XX.XX) = MILLIMETERS
- * = DIMENSIONS ARE TO INTERSECTION OF LINES
- ⊗ = HEADSPACE DIMENSION

DO NOT SCALE FROM DRAWING

NOTICE: This drawing is subject to change.
 Revisions, if applicable, are available at www.saami.org.

ISSUED: 07/28/1993 **6.5X55 SWEDISH [6.5X55]** REVISED: 12/03/2021

CARTRIDGE

UNLESS OTHERWISE NOTED
 BODY DIA. -.008 (0.20)

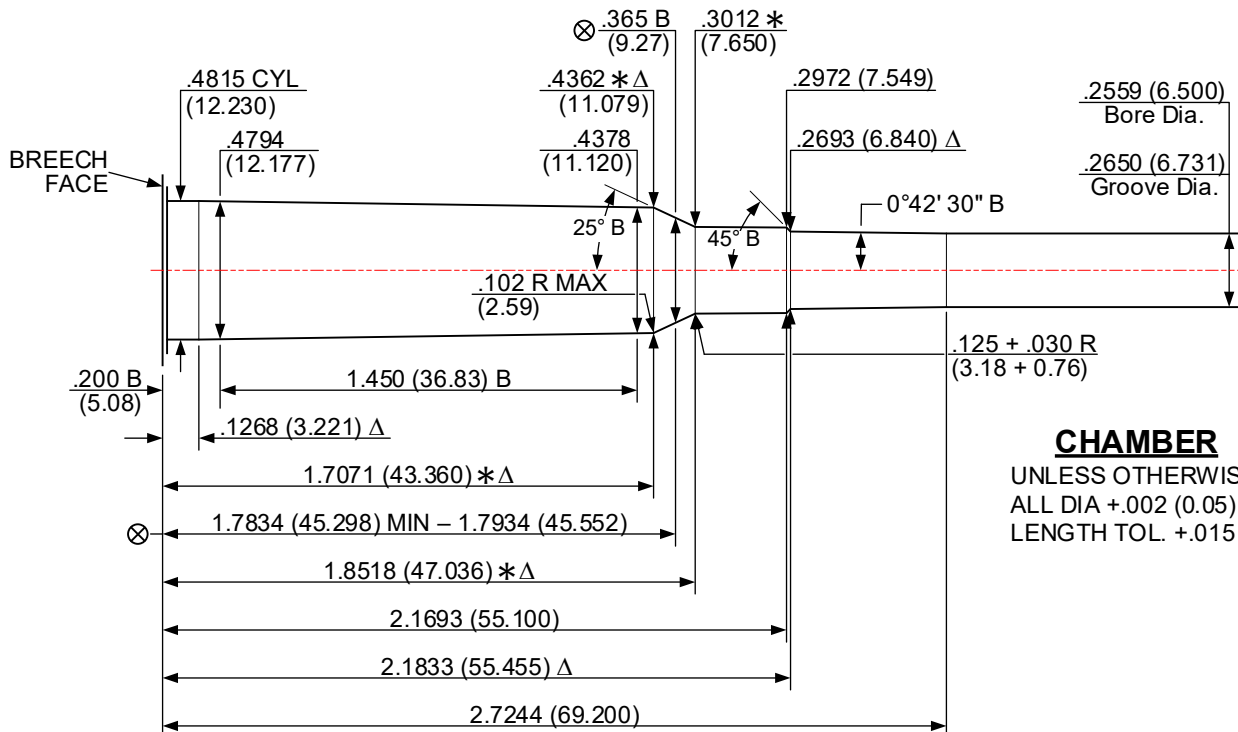
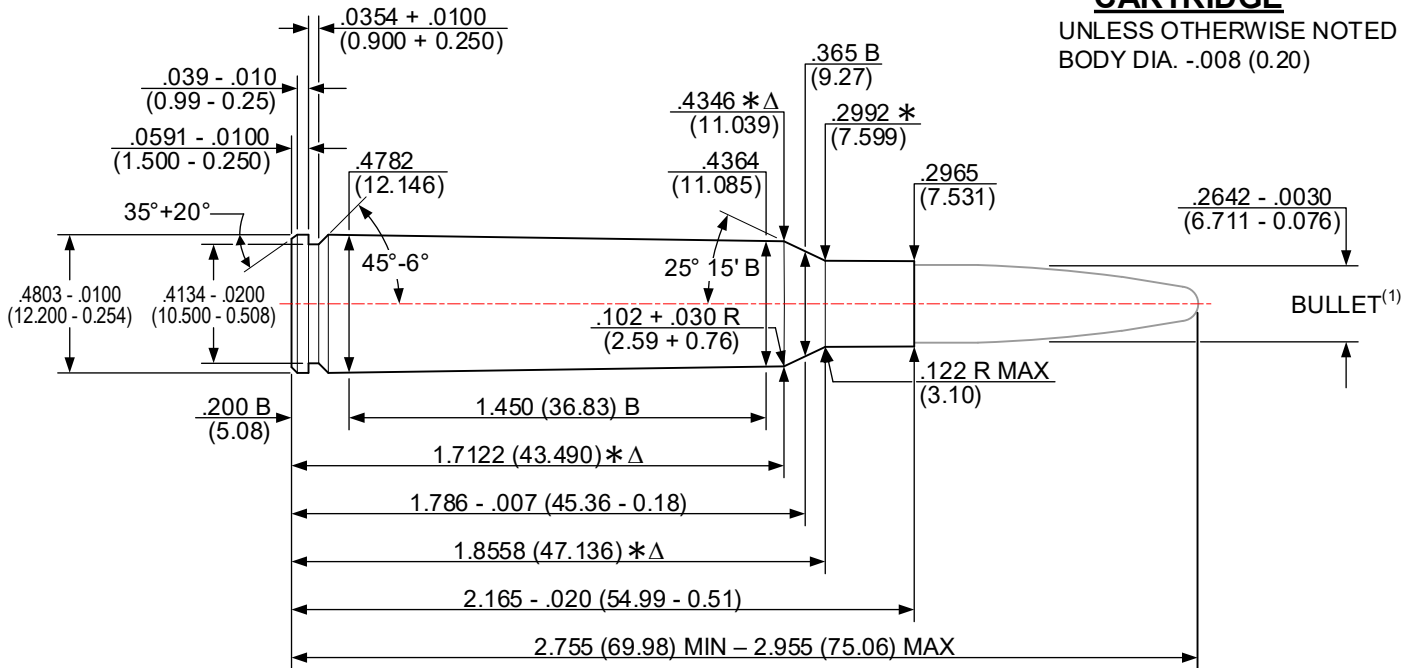

CHAMBER

UNLESS OTHERWISE NOTED
 ALL DIA +.002 (0.05)
 LENGTH TOL. +.015 (0.38)

Δ 4 GROOVES TWIST: 8.00 (203.2) R.H. OPTIONAL
 Δ .098+.002 (2.49+0.05) WIDE MINIMUM BORE & GROOVE AREA: .0532 in² (34.322 mm²)

NOTES:

- B = BASIC (XX.XX) = MILLIMETERS ⊗ = HEADSPACE DIMENSION
- Δ = REFERENCE DIMENSION * = DIMENSIONS ARE TO INTERSECTION OF LINES
- ALL CALCULATIONS APPLY AT MAXIMUM MATERIAL CONDITION (MMC)
- (1) – BULLET PROFILE IS SHOWN FOR ILLUSTRATIVE PURPOSES ONLY

DO NOT SCALE FROM DRAWING

ISSUED: 01/16/2022 **6.8 TRUE VELOCITY COMPOSITE [6.8 TVC]** REVISED: 06/27/2023

WARNING: Maximum Average Pressure levels greater than 65,000 psi may present increased risk of unsafe cartridge case or firearm rupture and thus require cartridge case and/or firearm designs that depart from traditional practices (materials, construction, and other design criteria).
NOTE: This design is based on a polymer case. Typical dimensional tolerances and relationships between the cartridge and chamber dimensions may deviate from conventional designs.

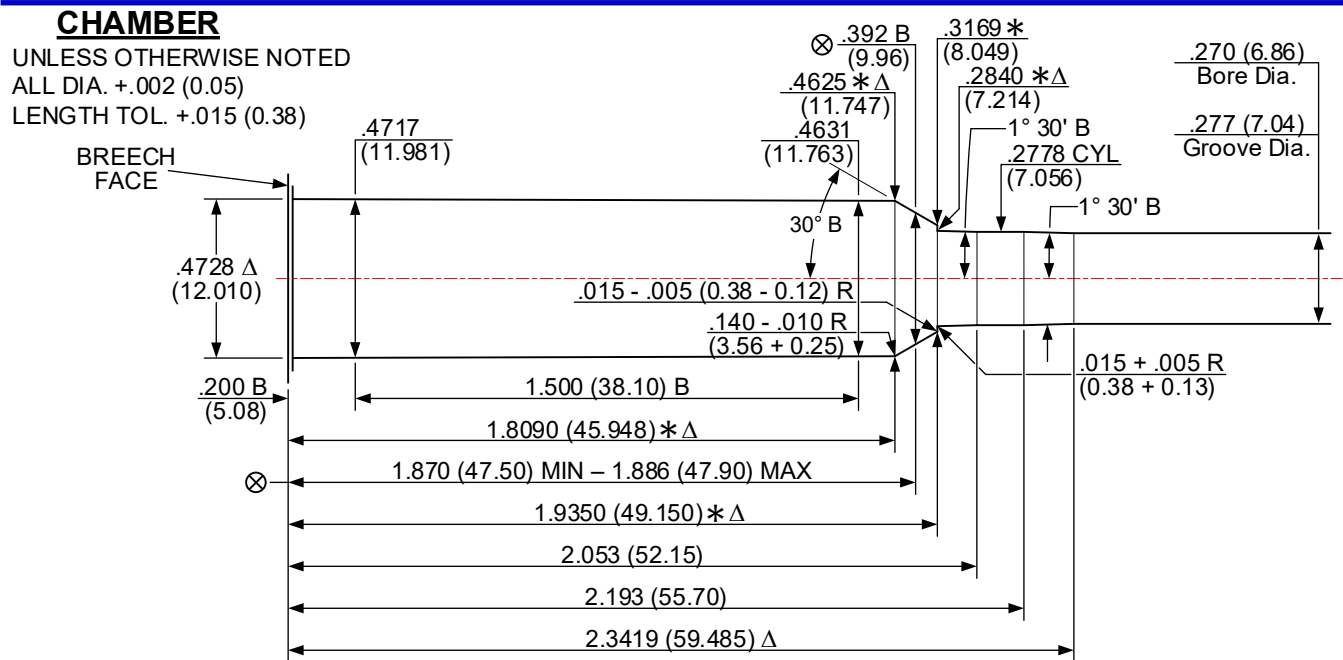
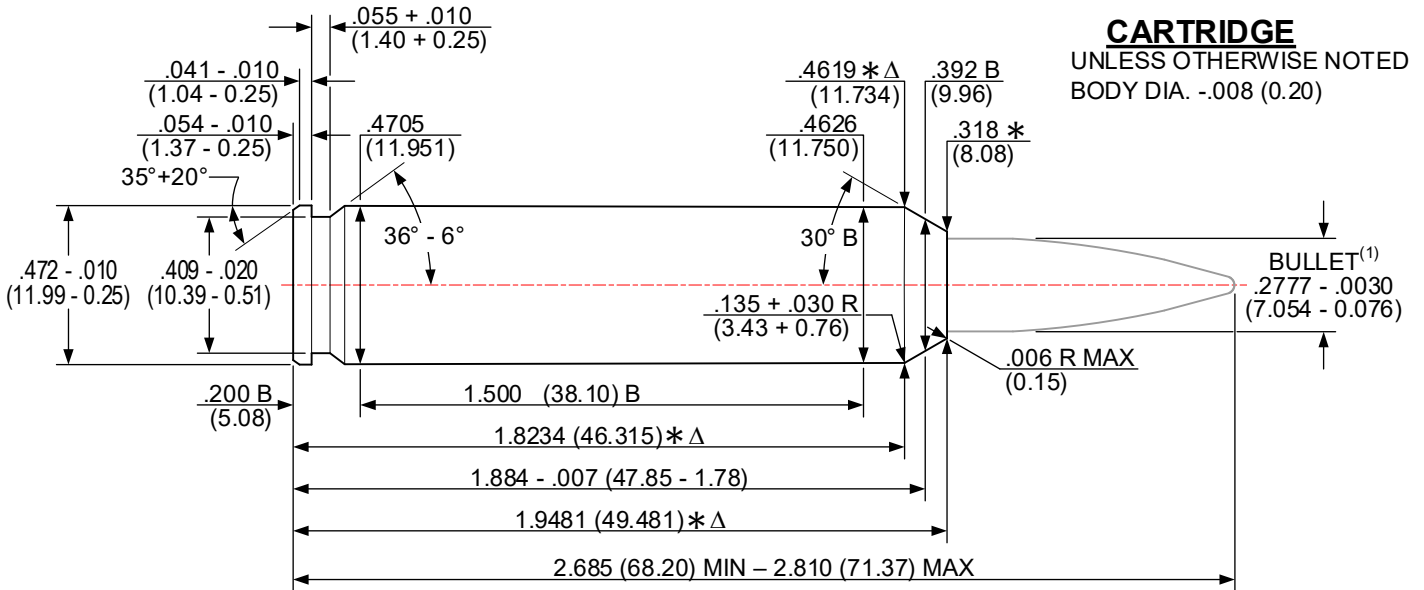

Δ 5 GROOVES TWIST: 8.00 (203.2) R.H. OPTIONAL
 Δ .120+.002 (3.05+0.05) WIDE MINIMUM BORE & GROOVE AREA: .0594 in² (38.322 mm²)

NOTES:
 B = BASIC (XX.XX) = MILLIMETERS ⊗ = HEADSPACE DIMENSION
 Δ = REFERENCE DIMENSION * = DIMENSIONS ARE TO INTERSECTION OF LINES
 ALL CALCULATIONS APPLY AT MAXIMUM MATERIAL CONDITION (MMC)
 (1) – BULLET PROFILE IS SHOWN FOR ILLUSTRATIVE PURPOSES ONLY

DO NOT SCALE FROM DRAWING

NOTICE: This drawing is subject to change.
 Revisions, if applicable, are available at www.saami.org.

ISSUED: 09/23/2020

6.8 WESTERN [6.8 WESTERN]

REVISED: 11/17/2021

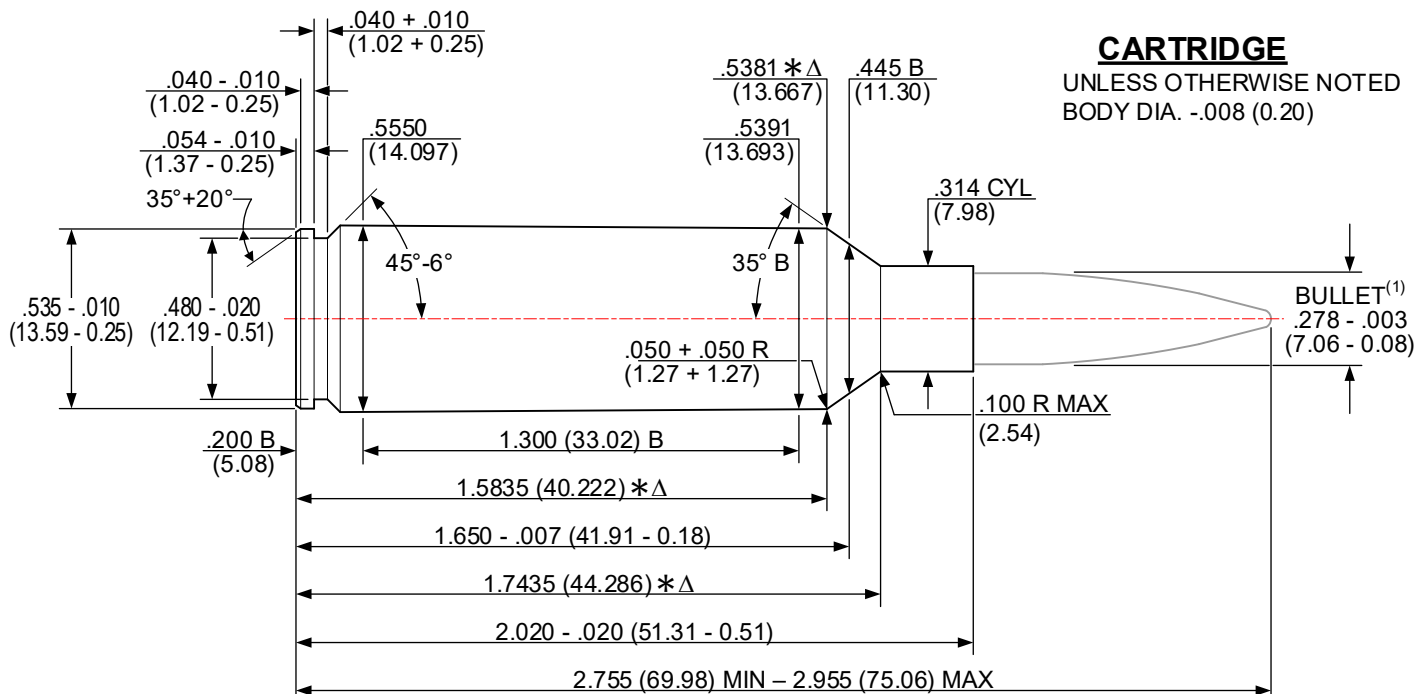

CARTRIDGE

UNLESS OTHERWISE NOTED
 BODY DIA. -.008 (0.20)

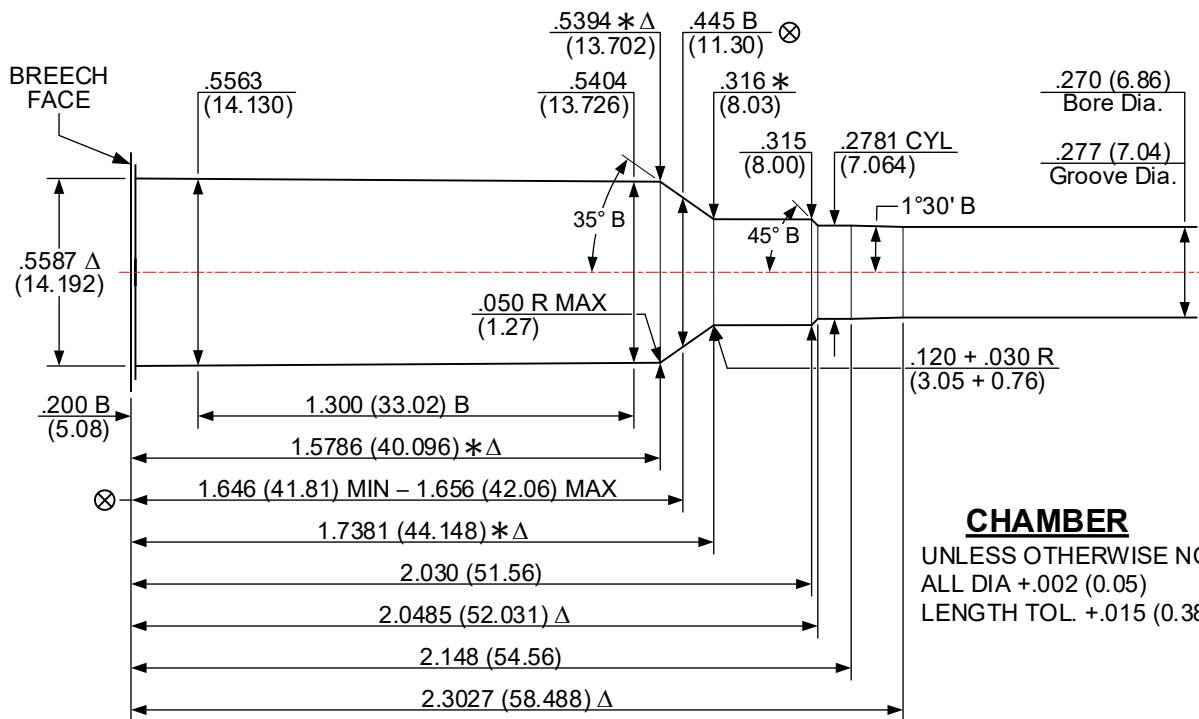

CHAMBER

UNLESS OTHERWISE NOTED
 ALL DIA +.002 (0.05)
 LENGTH TOL. +.015 (0.38)

Δ 6 GROOVES TWIST: 8.00 (203.2) R.H. OPTIONAL
 Δ .095+.002 (2.41+0.05) WIDE MINIMUM BORE & GROOVE AREA: .0592 in² (38.193 mm²)

NOTES:

- B = BASIC (XX.XX) = MILLIMETERS ⊗ = HEADSPACE DIMENSION
- Δ = REFERENCE DIMENSION * = DIMENSIONS ARE TO INTERSECTION OF LINES
- ALL CALCULATIONS APPLY AT MAXIMUM MATERIAL CONDITION (MMC)
- (1) – BULLET PROFILE IS SHOWN FOR ILLUSTRATIVE PURPOSES ONLY

DO NOT SCALE FROM DRAWING

NOTICE: This drawing is subject to change.
 Revisions, if applicable, are available at www.saami.org.

ISSUED: 06/23/2004 **6.8MM REMINGTON SPC [6.8MM REM SPC]** **REVISED: 10/26/2022**

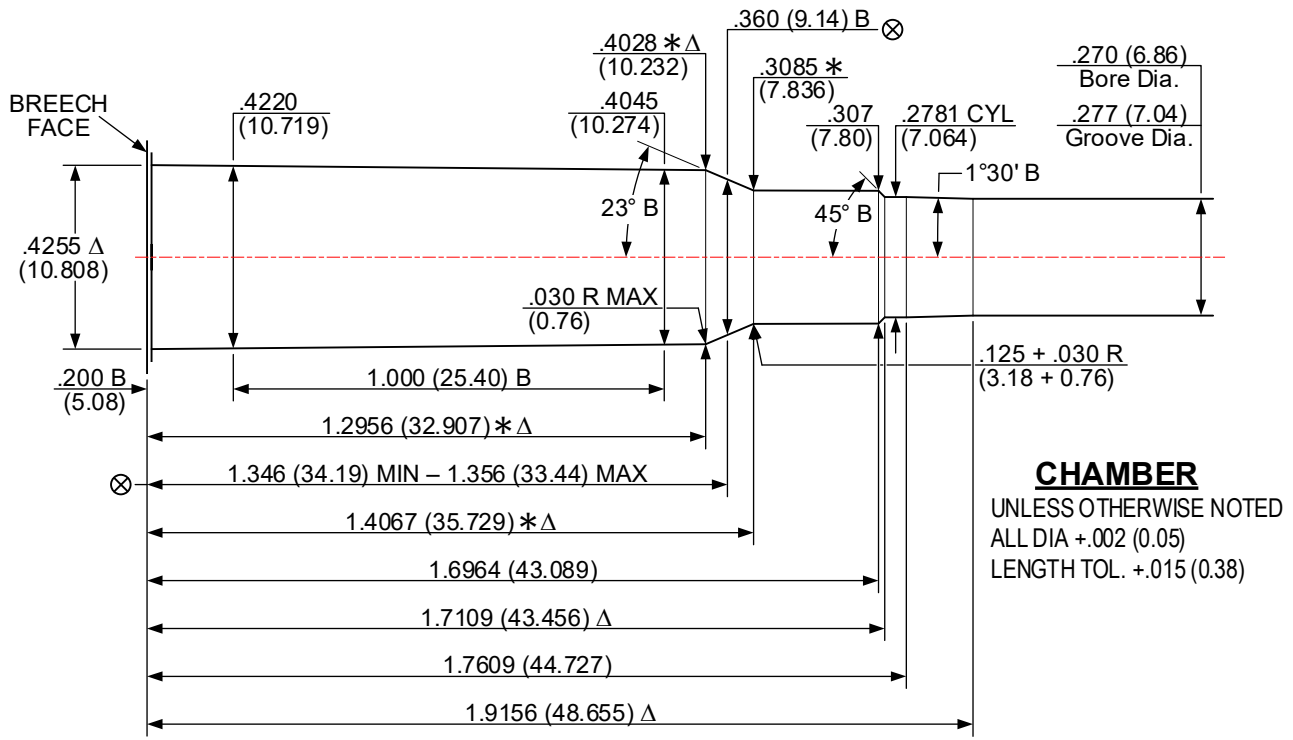
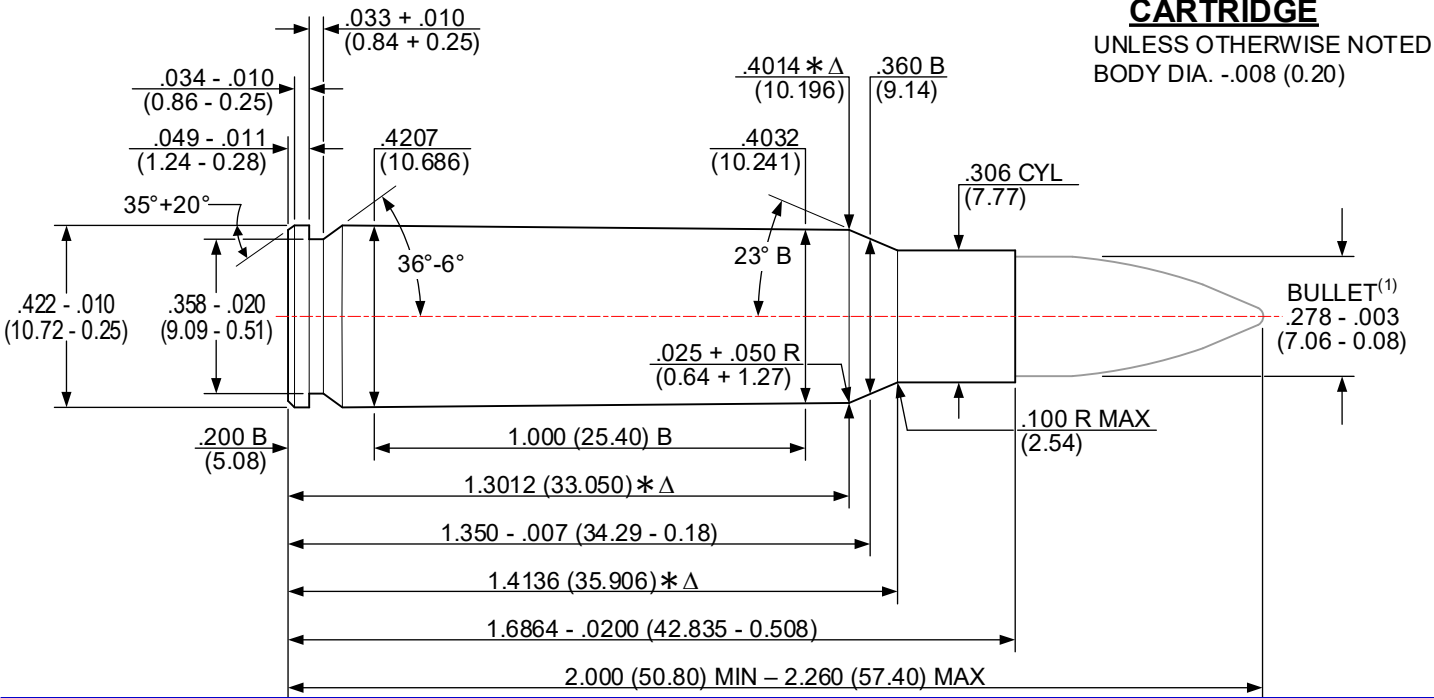

Δ 4 GROOVES TWIST: 10.00 (254.0) R.H. OPTIONAL
 Δ .160+.002 (4.06+0.05) WIDE MINIMUM BORE & GROOVE AREA: .0596 in² (38.451 mm²)

NOTES:
 B = BASIC (XX.XX) = MILLIMETERS ⊗ = HEADSPACE DIMENSION
 Δ = REFERENCE DIMENSION * = DIMENSIONS ARE TO INTERSECTION OF LINES
 ALL CALCULATIONS APPLY AT MAXIMUM MATERIAL CONDITION (MMC)
 (1) – BULLET PROFILE IS SHOWN FOR ILLUSTRATIVE PURPOSES ONLY

DO NOT SCALE FROM DRAWING

NOTICE: This drawing is subject to change.
 Revisions, if applicable, are available at www.saami.org.

ISSUED: 05/29/1979 **7MM MAUSER (7 X 57) [7MM (7 X 57)]** REVISED: 10/04/2022

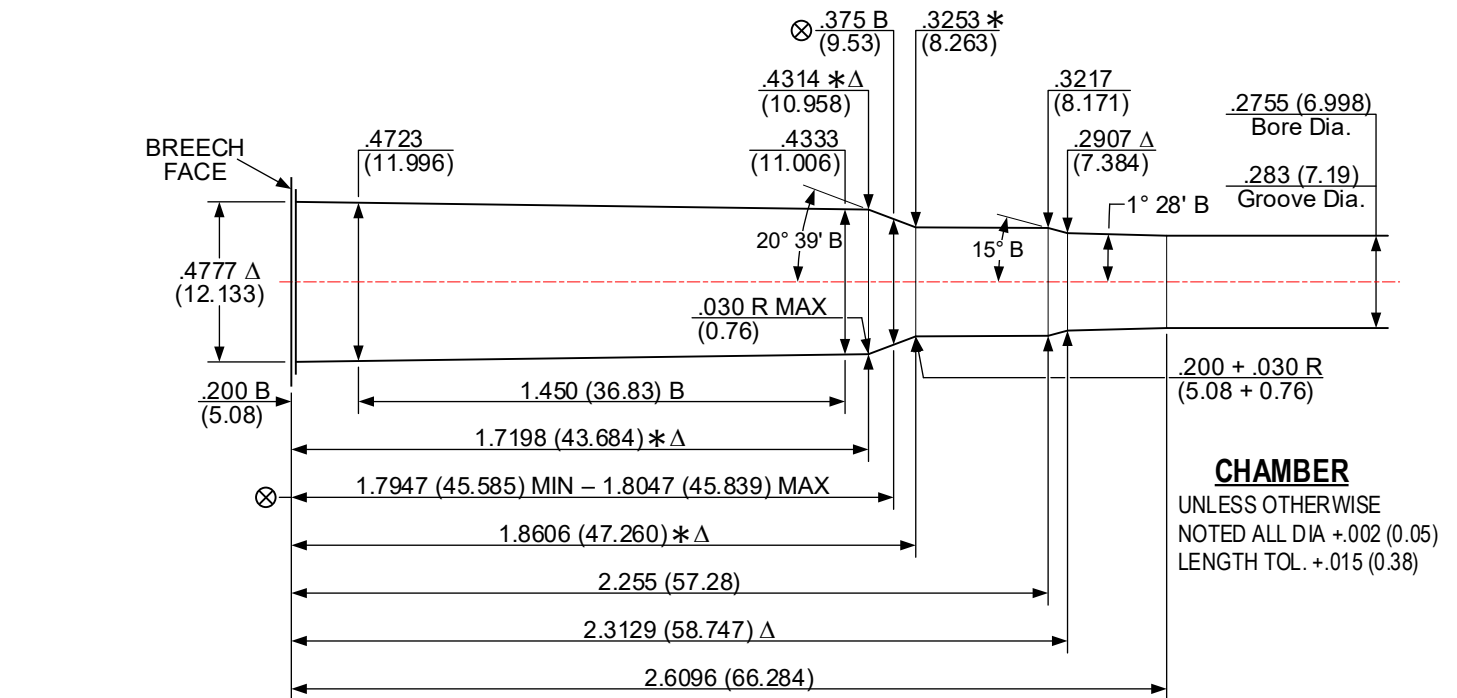
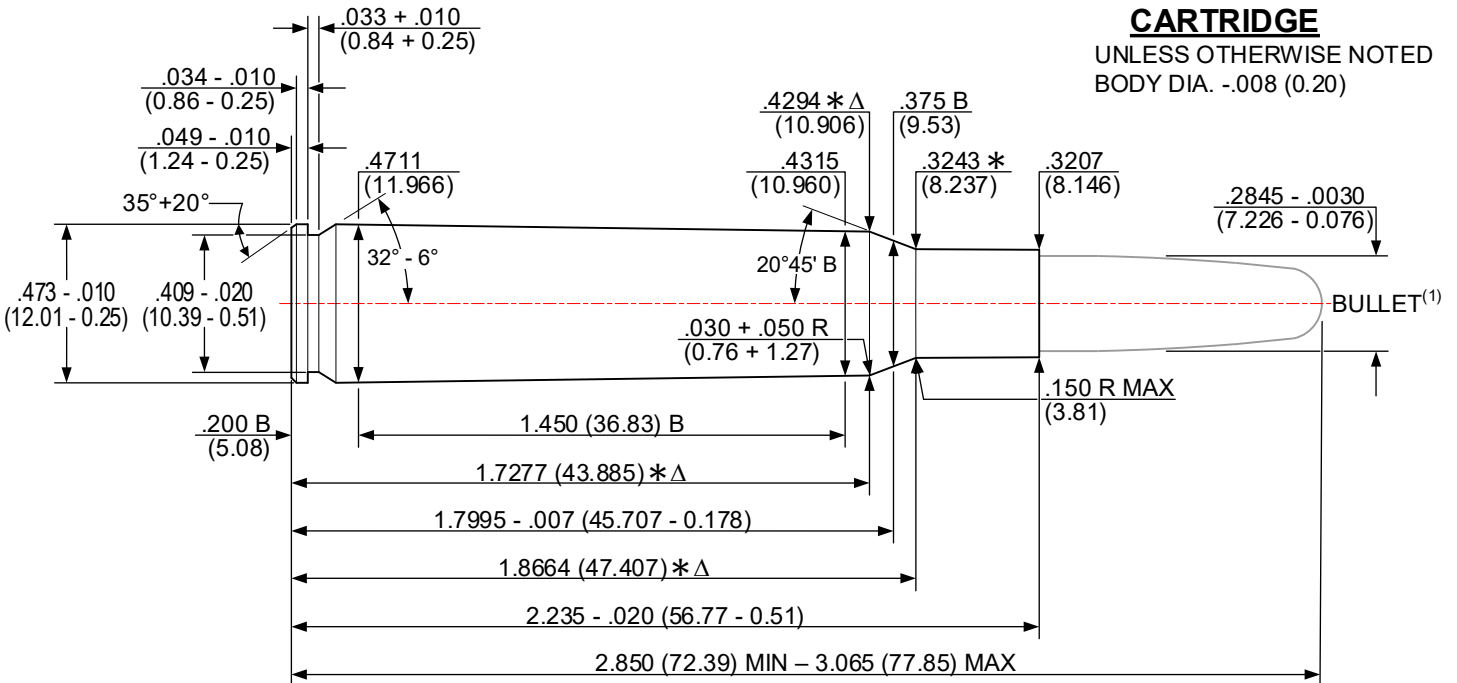

Δ 4 GROOVES TWIST: 8.75 (222.3) R.H. OPTIONAL
 Δ .160+.002 (4.06+0.05) WIDE MINIMUM BORE & GROOVE AREA: .0621 in² (40.064 mm²)

NOTES:
 B = BASIC (XX.XX) = MILLIMETERS ⊗ = HEADSPACE DIMENSION
 Δ = REFERENCE DIMENSION * = DIMENSIONS ARE TO INTERSECTION OF LINES
 ALL CALCULATIONS APPLY AT MAXIMUM MATERIAL CONDITION (MMC)
 (1) – BULLET PROFILE IS SHOWN FOR ILLUSTRATIVE PURPOSES ONLY

DO NOT SCALE FROM DRAWING

ISSUED: 06/07/2022 **7MM PRECISION RIFLE CARTRIDGE [7MM PRC]** REVISED: -/-/-/-/-

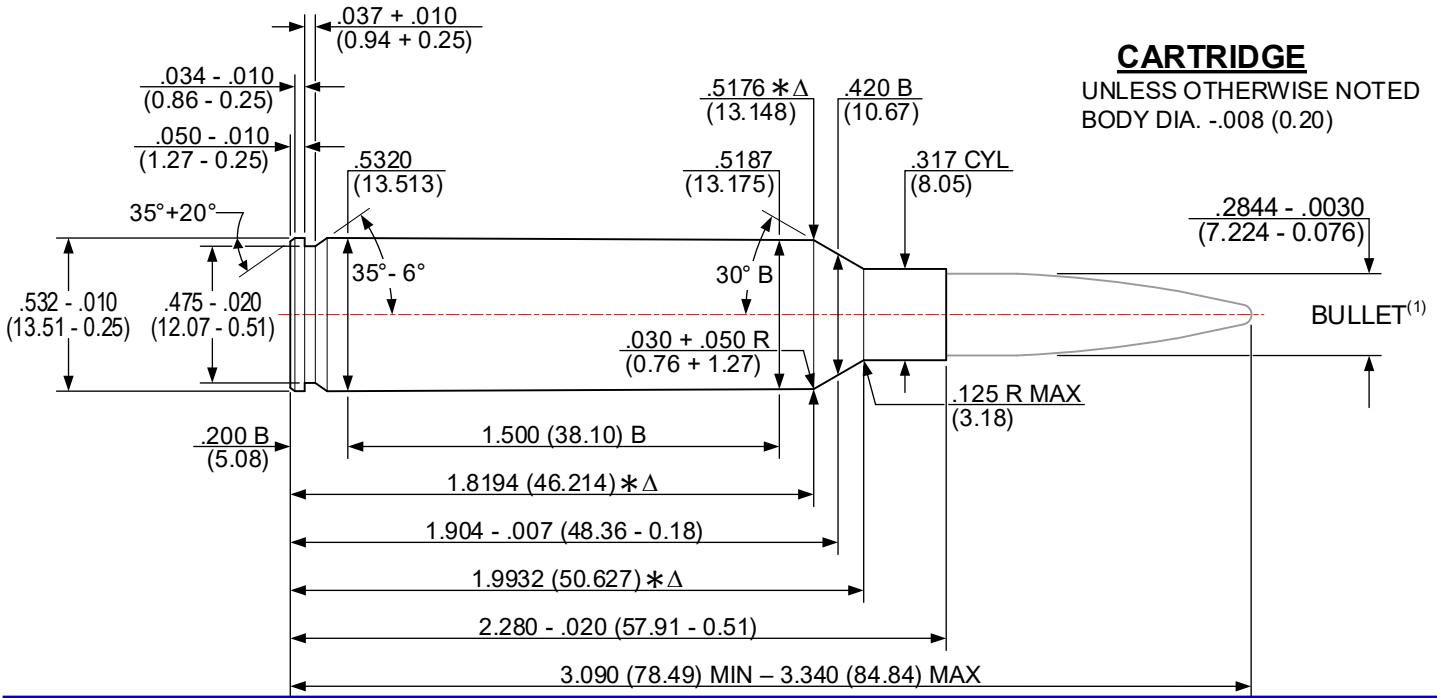

CARTRIDGE
 UNLESS OTHERWISE NOTED
 BODY DIA. -.008 (0.20)

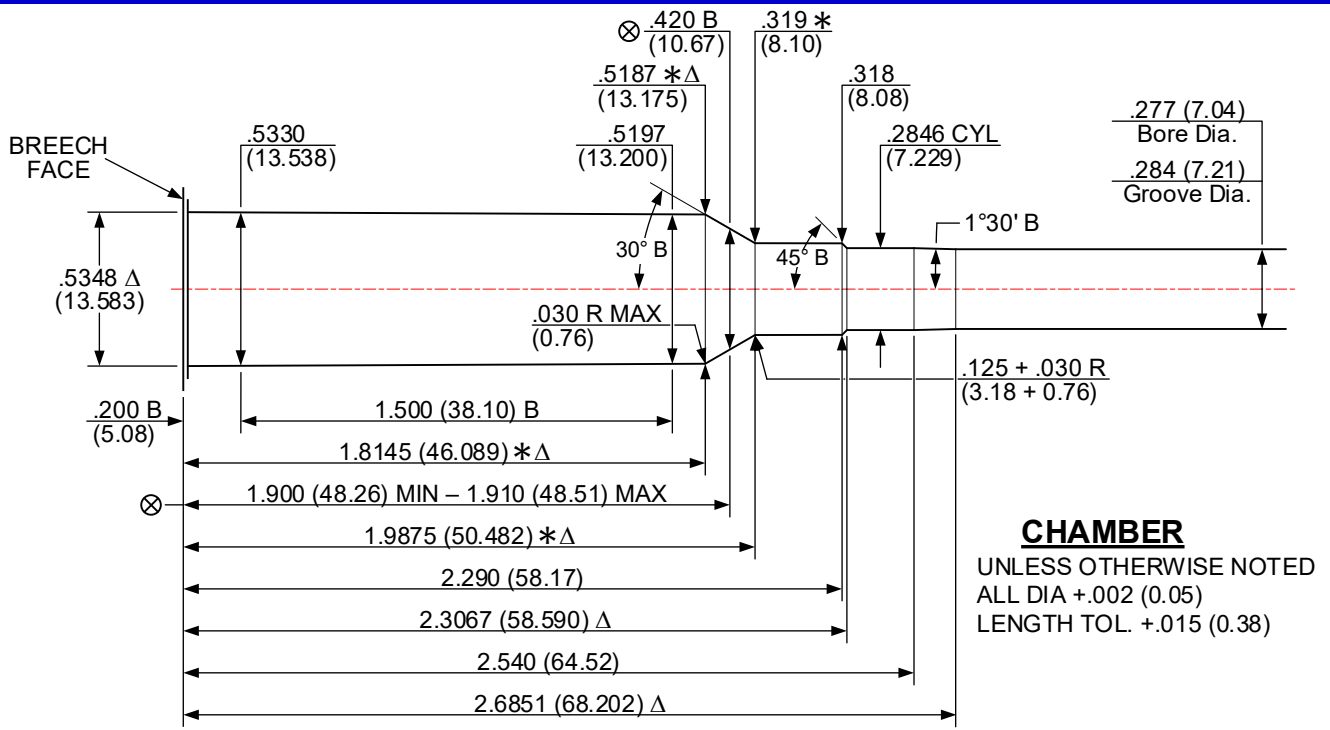

CHAMBER
 UNLESS OTHERWISE NOTED
 ALL DIA +.002 (0.05)
 LENGTH TOL. +.015 (0.38)

Δ 6 GROOVES TWIST: 8.00 (203.2) R.H. OPTIONAL
 Δ .110+.002 (2.79+0.05) WIDE MINIMUM BORE & GROOVE AREA: .0626 in² (40.387 mm²)

NOTES:
 B = BASIC (XX.XX) = MILLIMETERS ⊗ = HEADSPACE DIMENSION
 Δ = REFERENCE DIMENSION * = DIMENSIONS ARE TO INTERSECTION OF LINES
 ALL CALCULATIONS APPLY AT MAXIMUM MATERIAL CONDITION (MMC)
 (1) – BULLET PROFILE IS SHOWN FOR ILLUSTRATIVE PURPOSES ONLY

DO NOT SCALE FROM DRAWING

NOTICE: This drawing is subject to change.
 Revisions, if applicable, are available at www.saami.org.

ISSUED: 04/21/1980 **7MM REMINGTON MAGNUM [7MM REM MAG]** REVISED: 12/06/2021

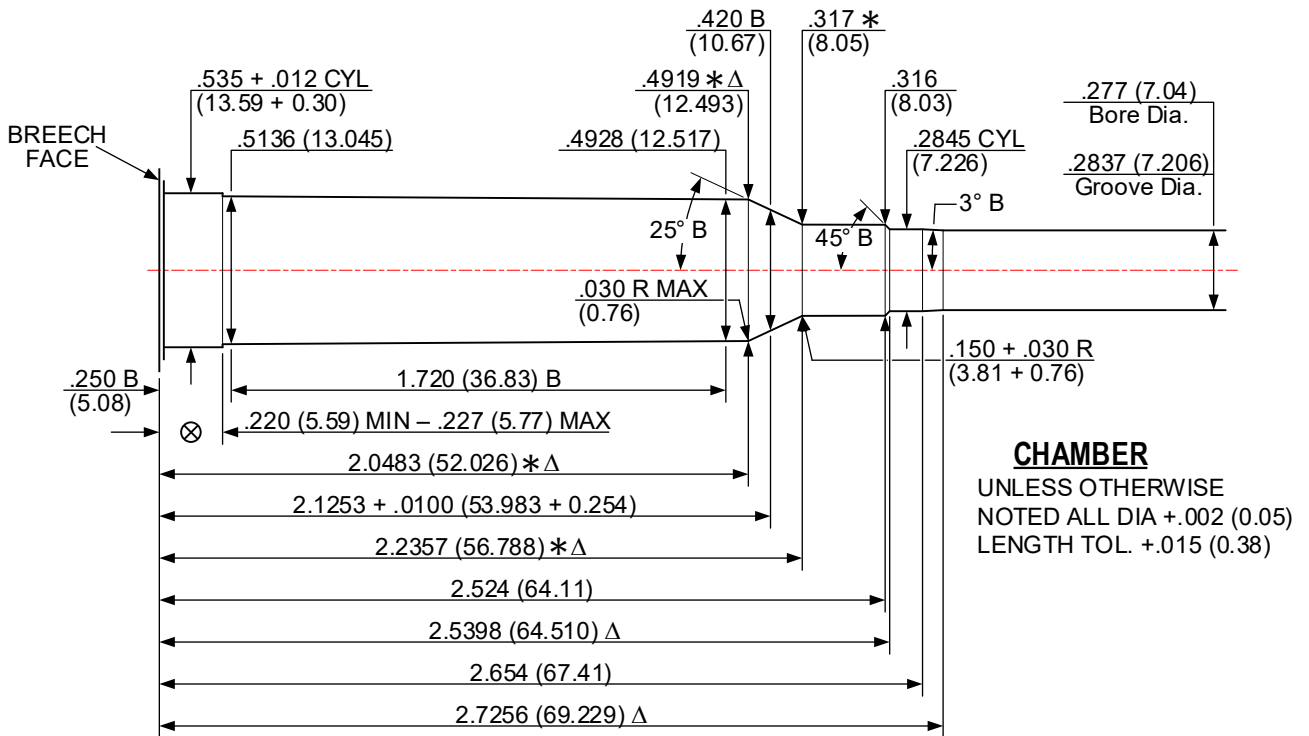
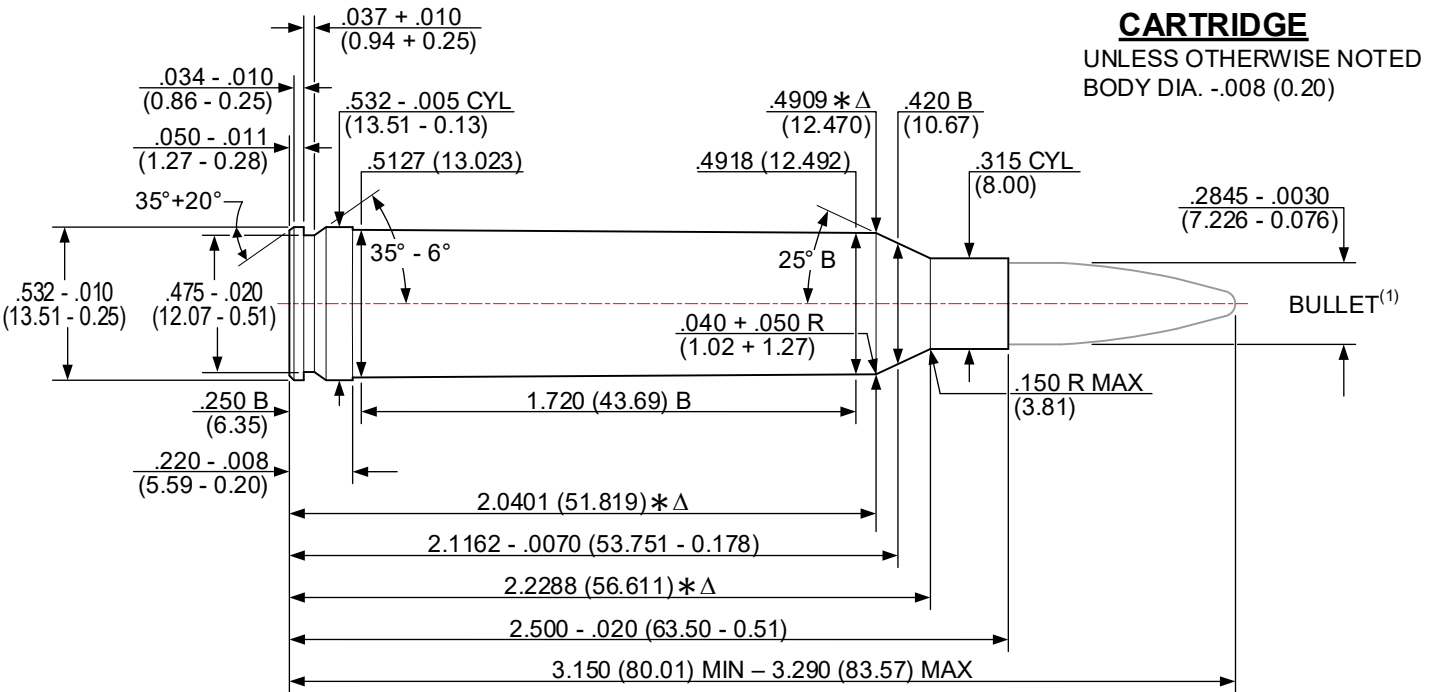

Δ 6 GROOVES TWIST: 9.5 (241.3) R.H. OPTIONAL
 Δ .110+.002 (4.06+0.05) WIDE MINIMUM BORE & GROOVE AREA: .0625 in² (40.322 mm²)

NOTES:
 B = BASIC (XX.XX) = MILLIMETERS \otimes = HEADSPACE DIMENSION
 Δ = REFERENCE DIMENSION * = DIMENSIONS ARE TO INTERSECTION OF LINES
 ALL CALCULATIONS APPLY AT MAXIMUM MATERIAL CONDITION (MMC)
 (1) – BULLET PROFILE IS SHOWN FOR ILLUSTRATIVE PURPOSES ONLY

DO NOT SCALE FROM DRAWING

NOTICE: This drawing is subject to change.
 Revisions, if applicable, are available at www.saami.org.

7MM REMINGTON SHORT ACTION ULTRA MAGNUM [7MM REM SA ULTRA MAG]
 ISSUED: 02/01/2002 REVISED: 12/06/2021

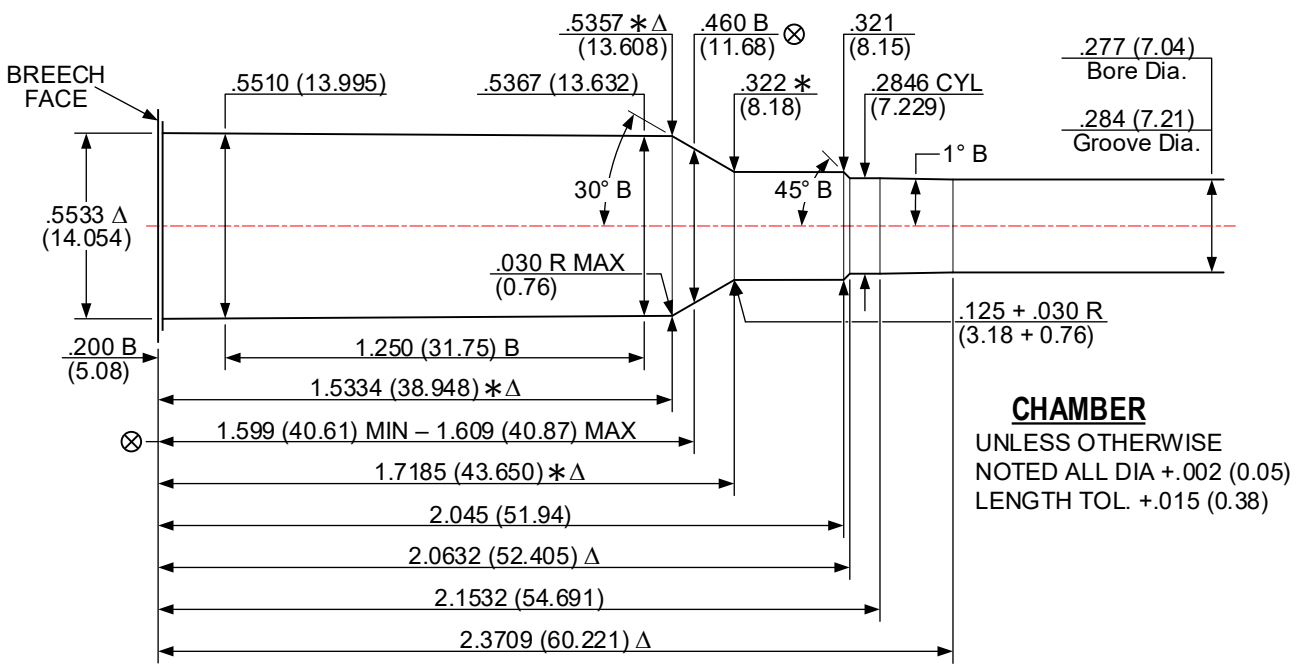
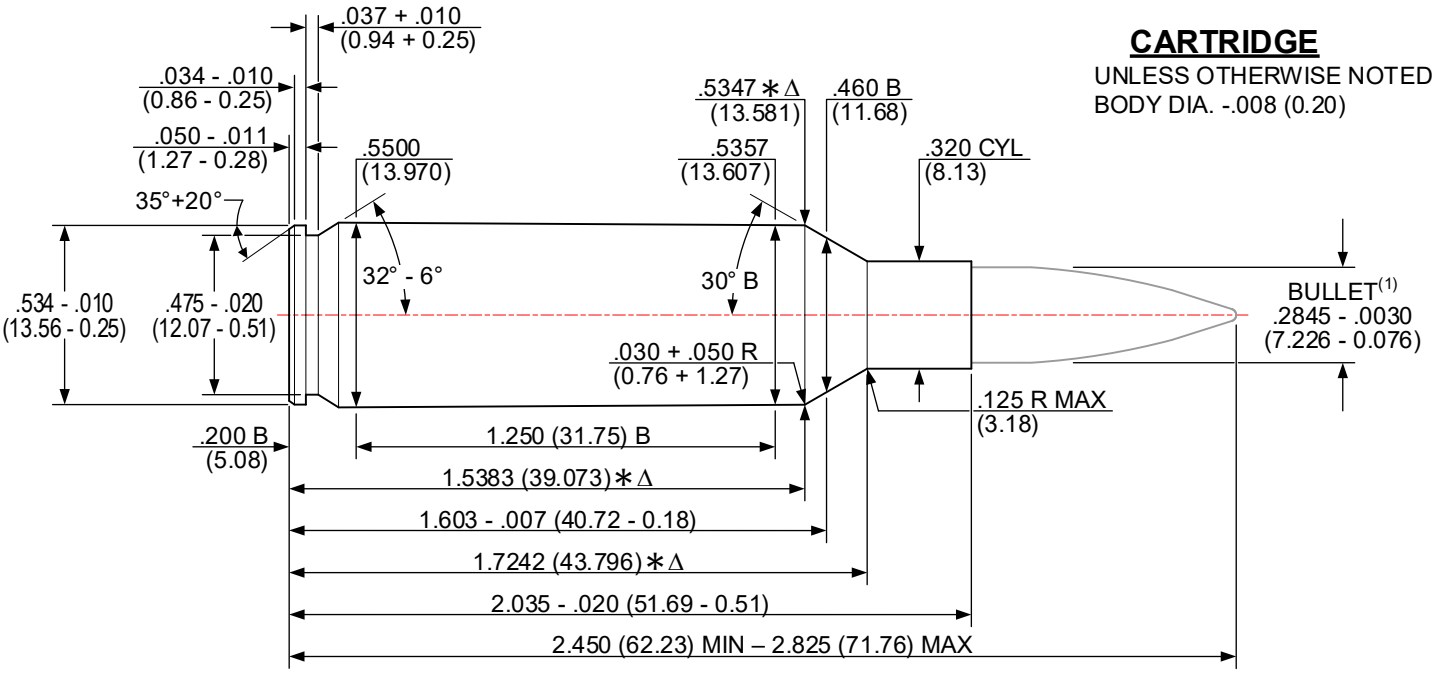

Δ 6 GROOVES TWIST: 9.25 (235.0) R.H. OPTIONAL
 Δ .110+.002 (2.79+0.05) WIDE MINIMUM BORE & GROOVE AREA: .0626 in² (40.387 mm²)

- NOTES:**
 B = BASIC (XX.XX) = MILLIMETERS ⊗ = HEADSPACE DIMENSION
 Δ = REFERENCE DIMENSION * = DIMENSIONS ARE TO INTERSECTION OF LINES
 ALL CALCULATIONS APPLY AT MAXIMUM MATERIAL CONDITION (MMC)
 (1) – BULLET PROFILE IS SHOWN FOR ILLUSTRATIVE PURPOSES ONLY

DO NOT SCALE FROM DRAWING

NOTICE: This drawing is subject to change.
 Revisions, if applicable, are available at www.saami.org.

7MM REMINGTON ULTRA MAGNUM [7MM REM ULTRA MAG]
 ISSUED: 02/01/2002 REVISED: 12/07/2021

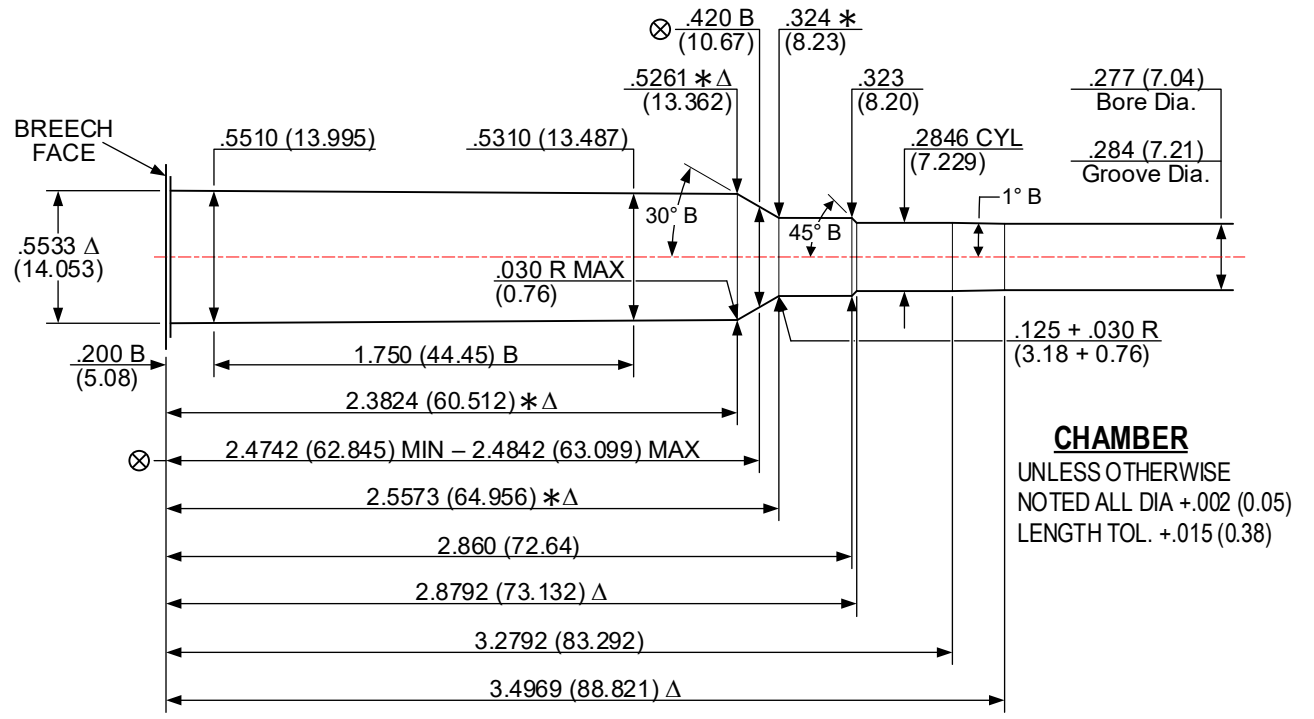
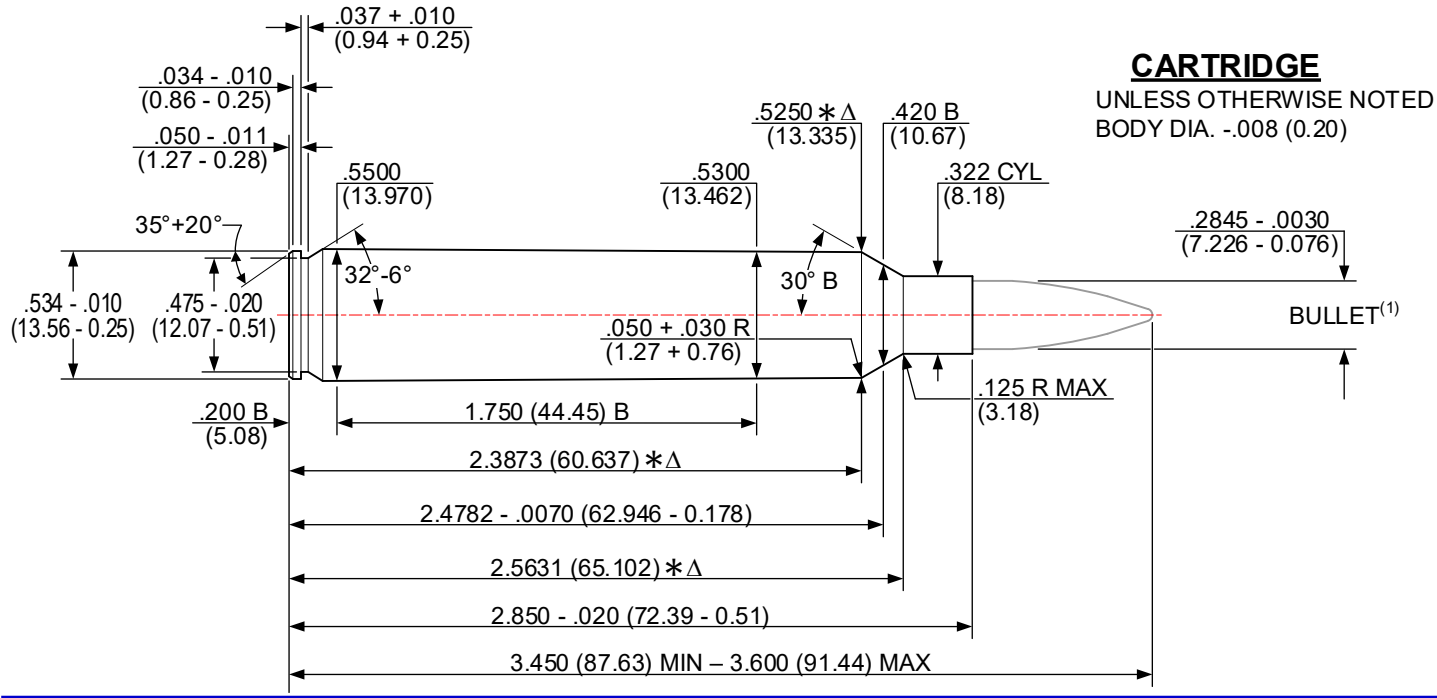

Δ 6 GROOVES TWIST: 9.5 (241.3) R.H. OPTIONAL
 Δ .110+.002 (2.79+0.05) WIDE MINIMUM BORE & GROOVE AREA: .0626 in² (40.387 mm²)

- NOTES:**
 B = BASIC (XX.XX) = MILLIMETERS ⊗ = HEADSPACE DIMENSION
 Δ = REFERENCE DIMENSION * = DIMENSIONS ARE TO INTERSECTION OF LINES
 ALL CALCULATIONS APPLY AT MAXIMUM MATERIAL CONDITION (MMC)
 (1) – BULLET PROFILE IS SHOWN FOR ILLUSTRATIVE PURPOSES ONLY

DO NOT SCALE FROM DRAWING

ISSUED: 06/04/1991 **7MM WEATHERBY MAGNUM [7MM WBY MAG]** REVISED: 01/21/2024

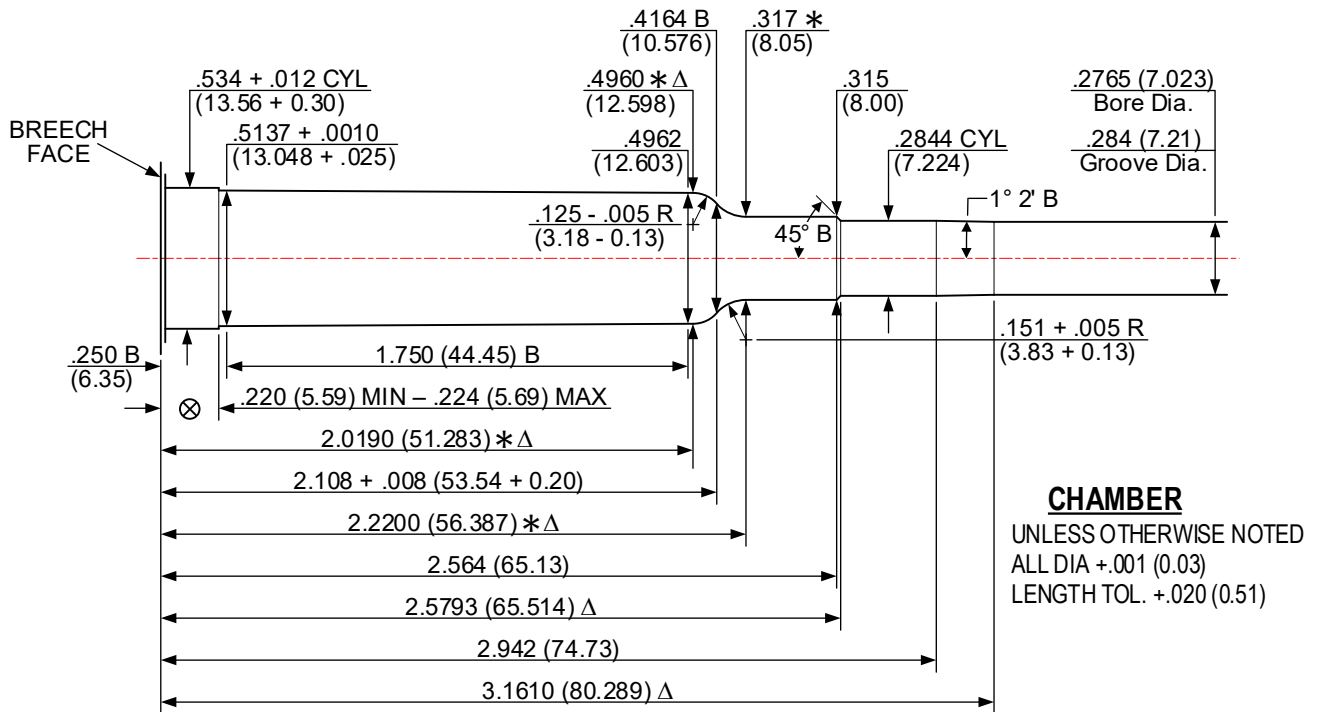
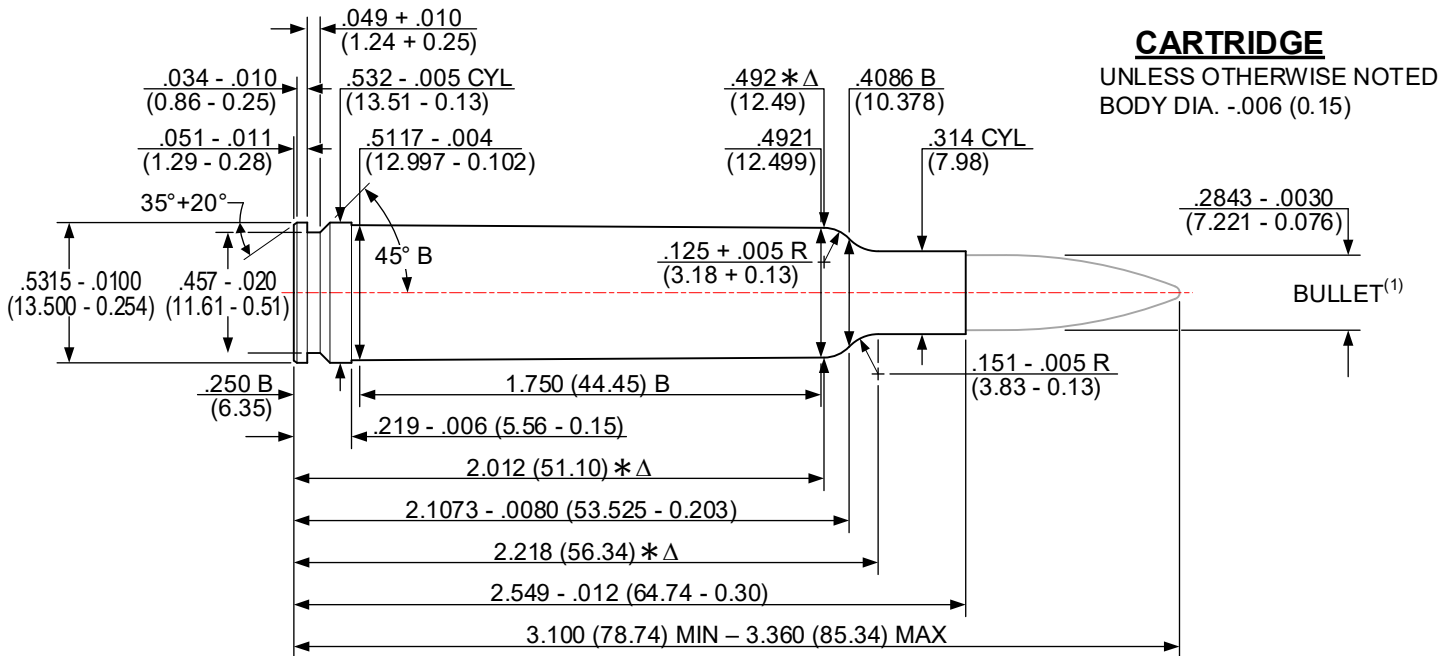

△ 6 GROOVES TWIST: 10.00 (254.0) R.H. OPTIONAL
 △ .113+.002 (2.87+0.05) WIDE MINIMUM BORE & GROOVE AREA: .0626 in² (40.387 mm²)

NOTE:
 B = BASIC (XX.XX) = MILLIMETERS ⊗ = HEADSPACE DIMENSION
 △ = REFERENCE DIMENSION * = DIMENSIONS ARE TO INTERSECTION OF LINES
 ALL CALCULATIONS APPLY AT MAXIMUM MATERIAL CONDITION (MMC)
 (1) – BULLET PROFILE IS SHOWN FOR ILLUSTRATIVE PURPOSES ONLY

DO NOT SCALE FROM DRAWING

ISSUED: 06/26/2002 **7MM WINCHESTER SHORT MAGNUM [7MM WSM]** REVISED: 01/11/2022

CARTRIDGE

UNLESS OTHERWISE NOTED
 BODY DIA. -.008 (0.20)

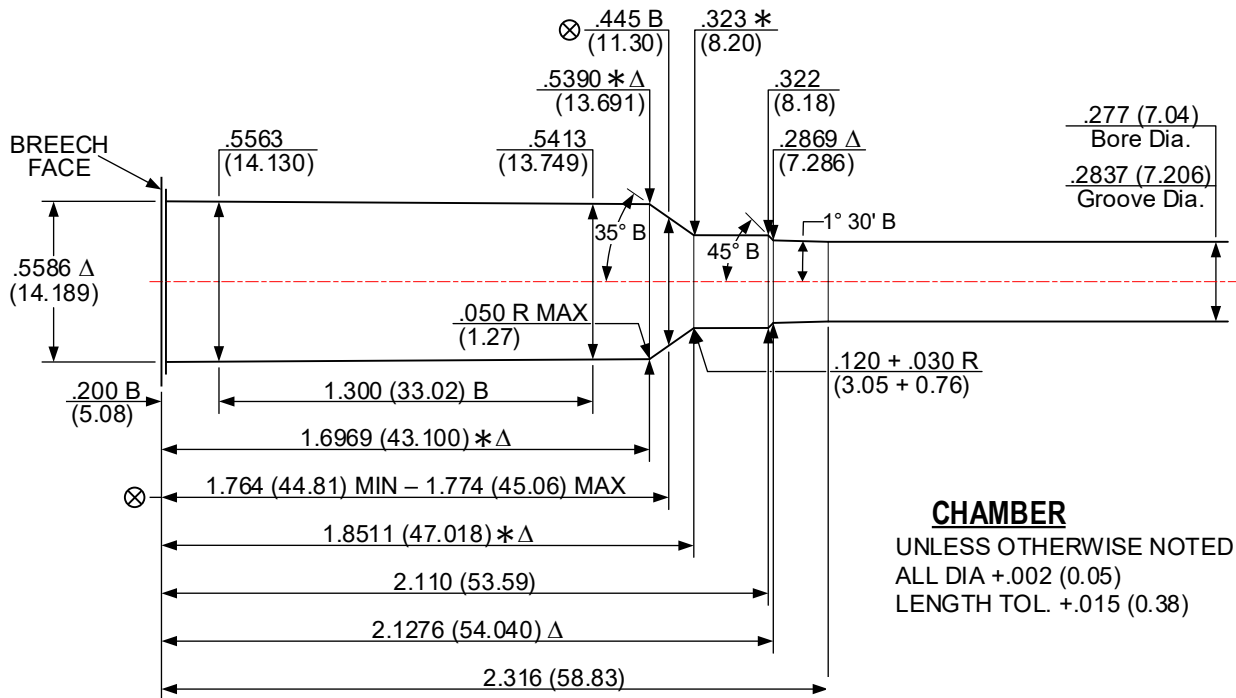
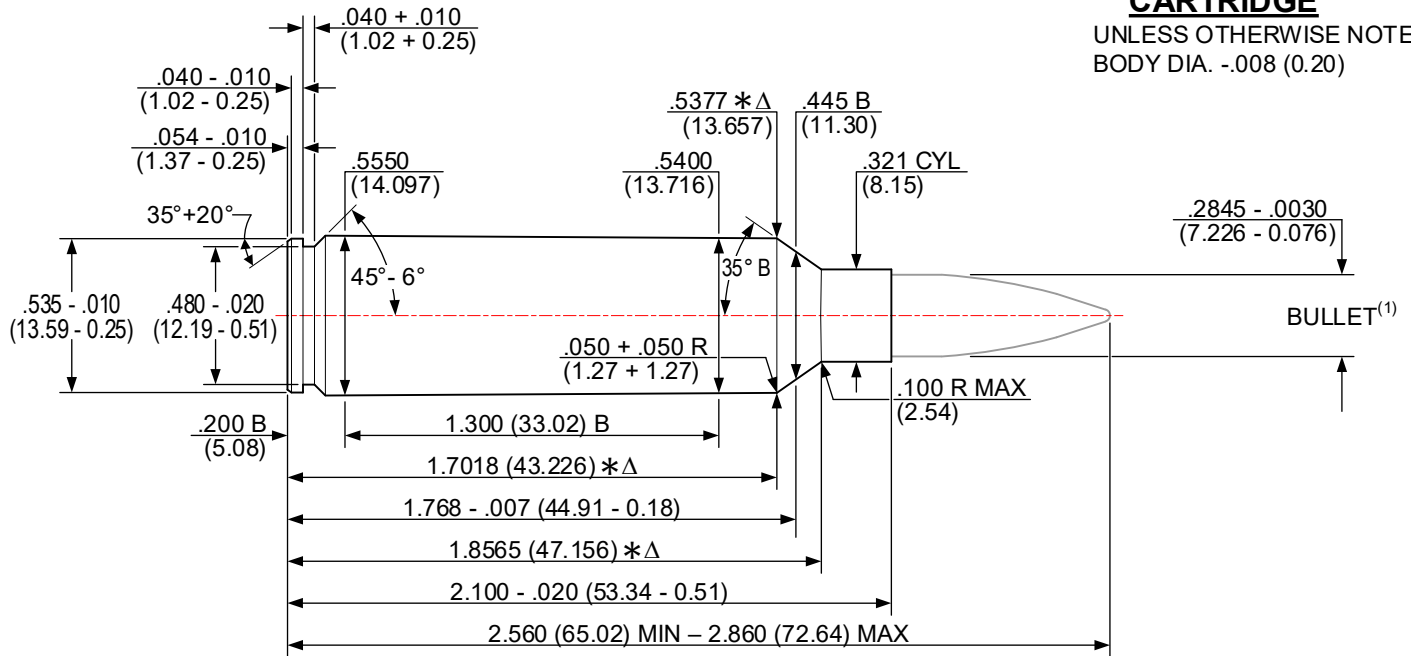

CHAMBER

UNLESS OTHERWISE NOTED
 ALL DIA +.002 (0.05)
 LENGTH TOL. +.015 (0.38)

Δ 6 GROOVES TWIST: 9.5 (241.3) R.H. OPTIONAL
 Δ .110+.002 (2.79+0.05) WIDE MINIMUM BORE & GROOVE ARE

NOTES:

- B = BASIC
- Δ = REFERENCE DIMENSION
- ALL CALCULATIONS APPLY AT MAXIMUM MATERIAL CONDITION (MMC)
- (1) – BULLET PROFILE IS SHOWN FOR ILLUSTRATIVE PURPOSES ONLY
- (XX.XX) = MILLIMETERS
- * = DIMENSIONS ARE TO INTERSECTION OF LINES
- ⊗ = HEADSPACE DIMENSION

DO NOT SCALE FROM DRAWING

NOTICE: This drawing is subject to change.
 Revisions, if applicable, are available at www.saami.org.

ISSUED: 04/21/1980 **7MM-08 REMINGTON [7MM-08 REM]** REVISED: 02/18/2022

CARTRIDGE

UNLESS OTHERWISE NOTED
 BODY DIA. -.008 (0.20)

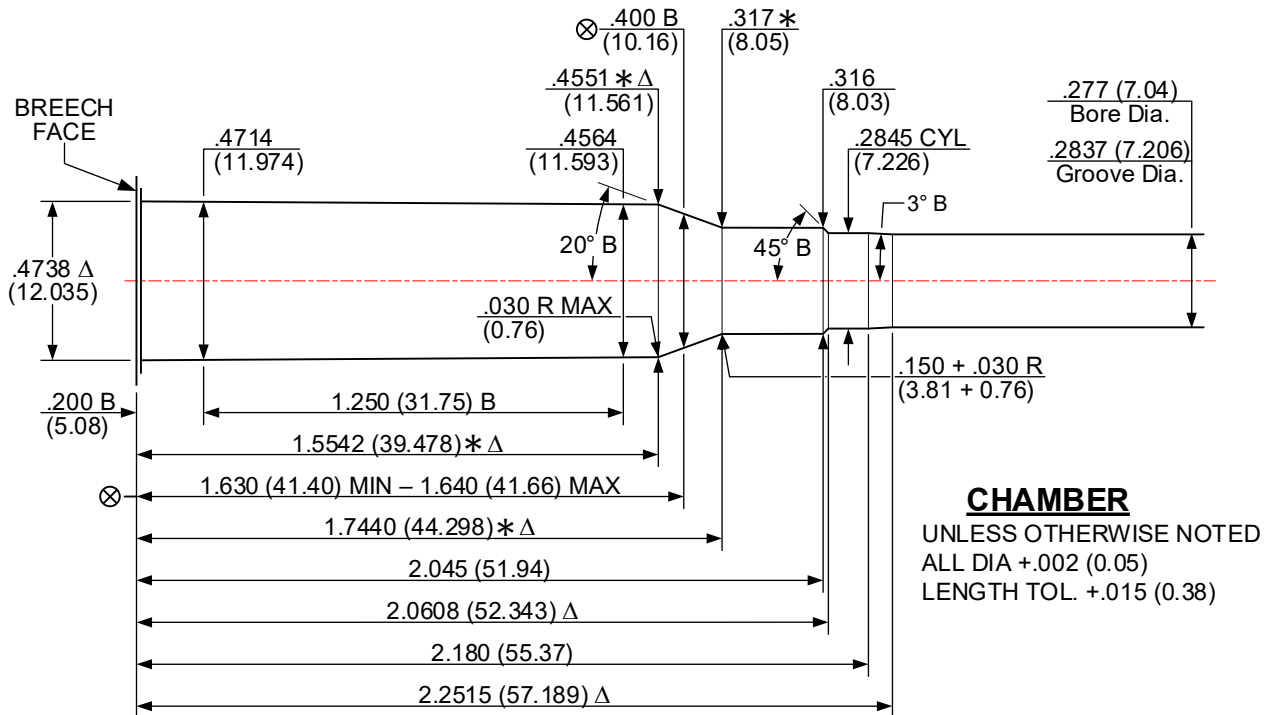
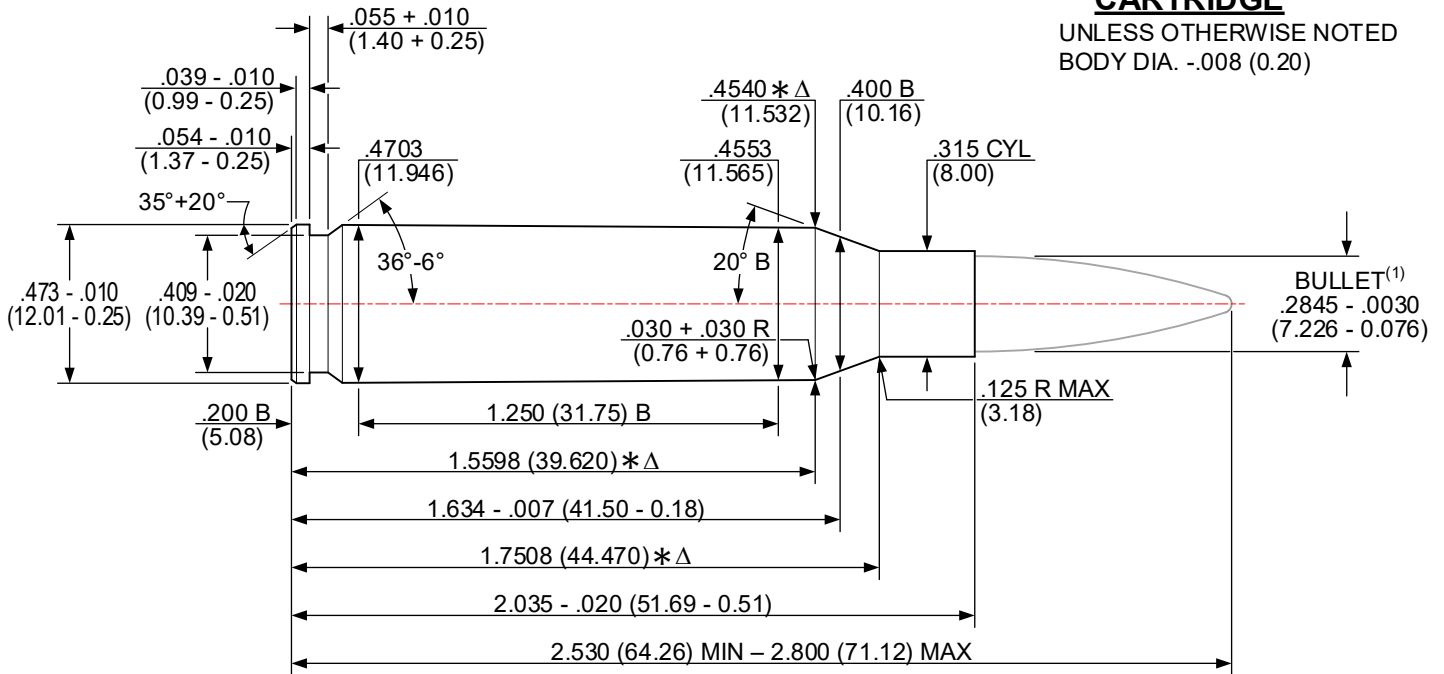

CHAMBER

UNLESS OTHERWISE NOTED
 ALL DIA +.002 (0.05)
 LENGTH TOL. +.015 (0.38)

Δ 6 GROOVES TWIST: 9.50 (241.3) R.H. OPTIONAL
 Δ .110+.002 (2.79+0.05) WIDE MINIMUM BORE & GROOVE AREA: .0625 in² (40.322 mm²)

NOTES:

- B = BASIC (XX.XX) = MILLIMETERS ⊗ = HEADSPACE DIMENSION
- Δ = REFERENCE DIMENSION * = DIMENSIONS ARE TO INTERSECTION OF LINES
- ALL CALCULATIONS APPLY AT MAXIMUM MATERIAL CONDITION (MMC)
- (1) – BULLET PROFILE IS SHOWN FOR ILLUSTRATIVE PURPOSES ONLY

DO NOT SCALE FROM DRAWING

ISSUED: 07/28/1993

7 x 64 BRENEKE [7 x 64]

REVISED: 06/17/2024

CARTRIDGE

UNLESS OTHERWISE NOTED
 BODY DIA. -.008 (0.20)

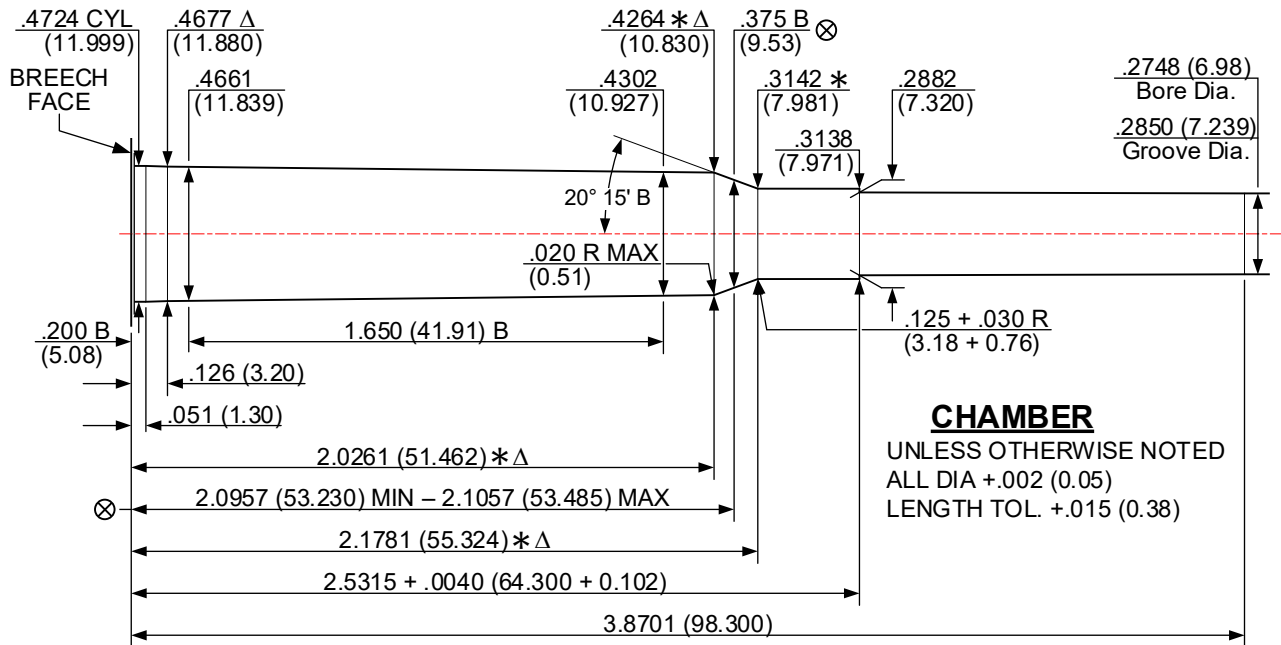
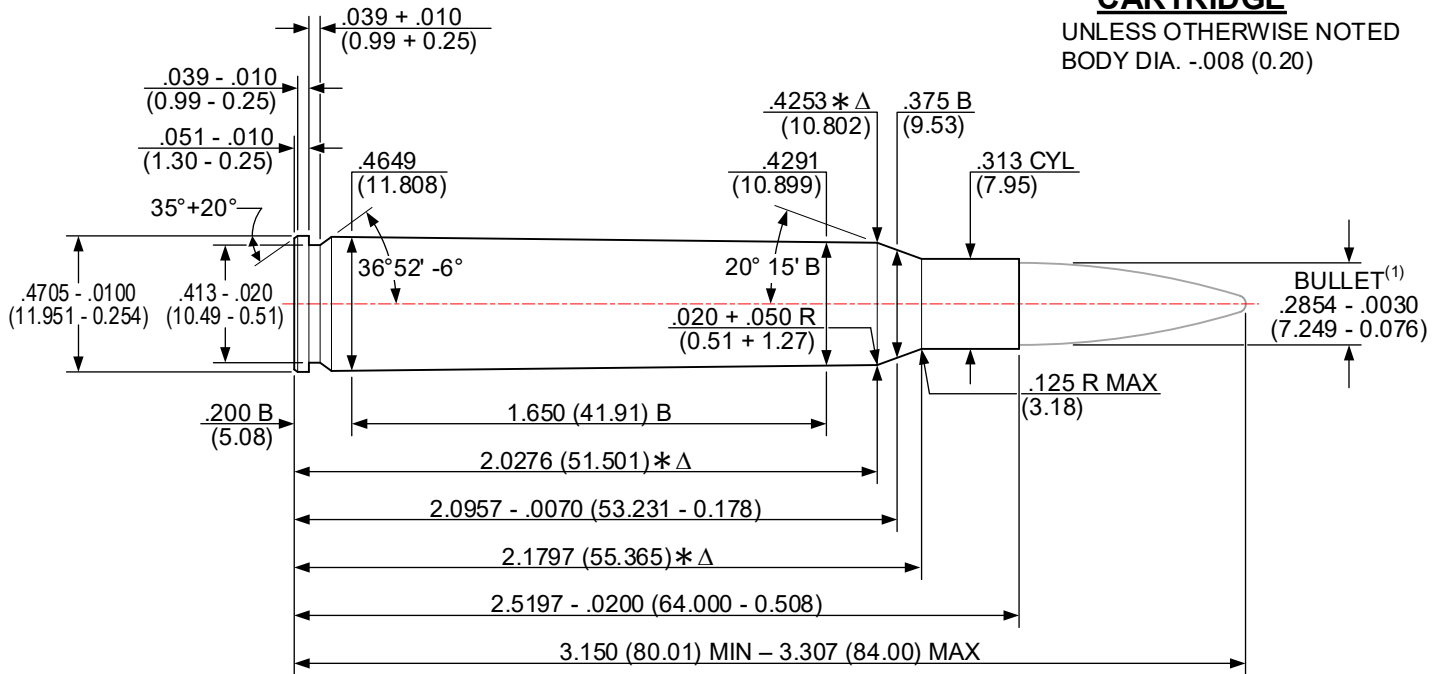

CHAMBER

UNLESS OTHERWISE NOTED
 ALL DIA +.002 (0.05)
 LENGTH TOL. +.015 (0.38)

Δ 4 GROOVES TWIST: 8.66 (220.0) R.H. OPTIONAL
 Δ .146+.002 (3.71+0.05) WIDE MINIMUM BORE & GROOVE AREA: .0624 in² (40.257 mm²)

NOTES:

- B = BASIC (XX.XX) = MILLIMETERS ⊗ = HEADSPACE DIMENSION
- Δ = REFERENCE DIMENSION * = DIMENSIONS ARE TO INTERSECTION OF LINES
- ALL CALCULATIONS APPLY AT MAXIMUM MATERIAL CONDITION (MMC)
- (1) – BULLET PROFILE IS SHOWN FOR ILLUSTRATIVE PURPOSES ONLY

DO NOT SCALE FROM DRAWING

NOTICE: This drawing is subject to change.
 Revisions, if applicable, are available at www.saami.org.

ISSUED: 08/01/1988 **7.62 x 39 [7.62 x 39]** REVISED: 02/28/2022

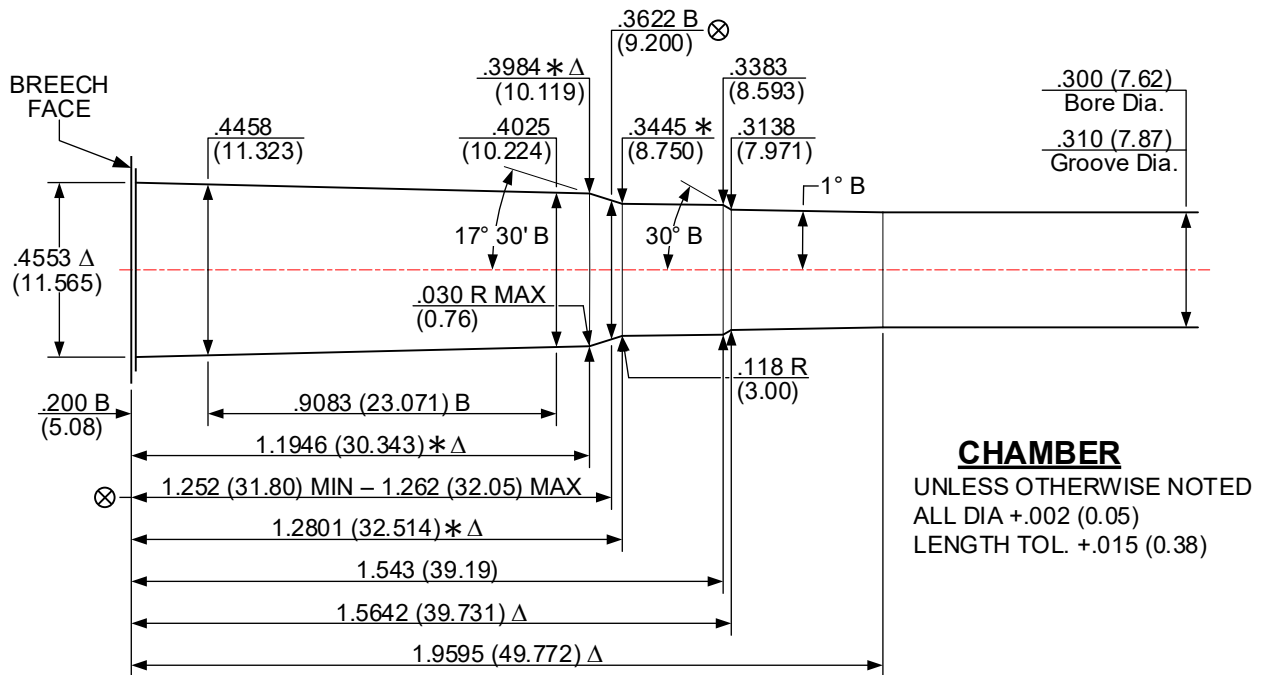
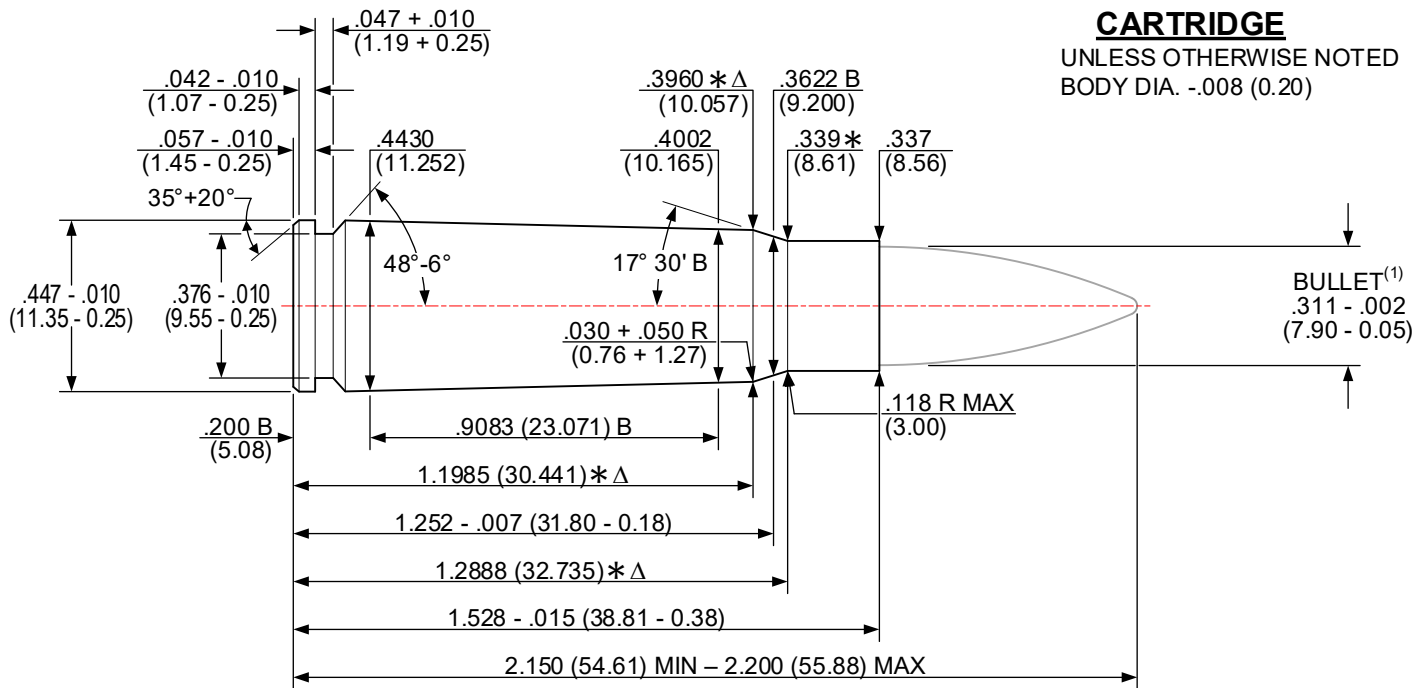

Δ 4 GROOVES TWIST: 9.45 (240.0) R.H. OPTIONAL
 Δ .150+.002 (3.80+0.05) WIDE MINIMUM BORE & GROOVE AREA: .0738 in² (47.612 mm²)

NOTES:
 B = BASIC (XX.XX) = MILLIMETERS ⊗ = HEADSPACE DIMENSION
 Δ = REFERENCE DIMENSION * = DIMENSIONS ARE TO INTERSECTION OF LINES
 ALL CALCULATIONS APPLY AT MAXIMUM MATERIAL CONDITION (MMC)
 (1) – BULLET PROFILE IS SHOWN FOR ILLUSTRATIVE PURPOSES ONLY

DO NOT SCALE FROM DRAWING

ISSUED: 04/21/1980

8MM MAUSER (8 x 57) [8MM (8 x 57)]

REVISED: 03/02/2022

CARTRIDGE

UNLESS OTHERWISE NOTED
 BODY DIA. -.008 (0.20)

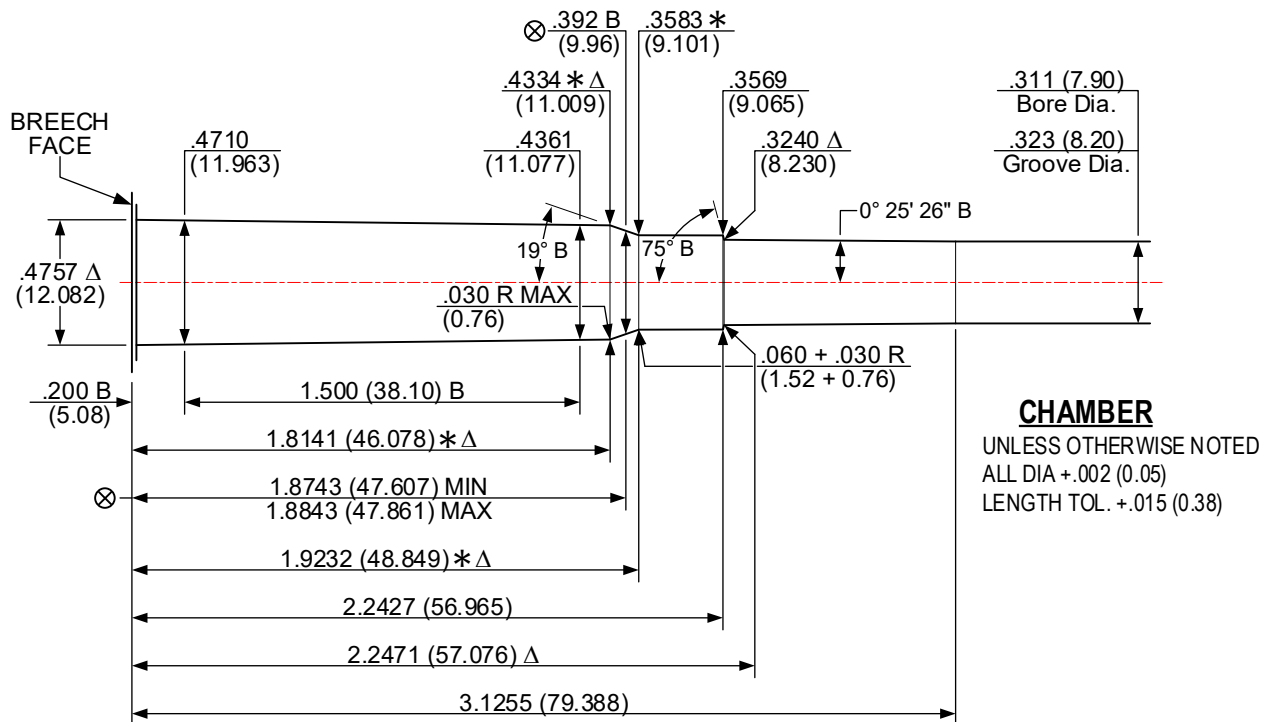
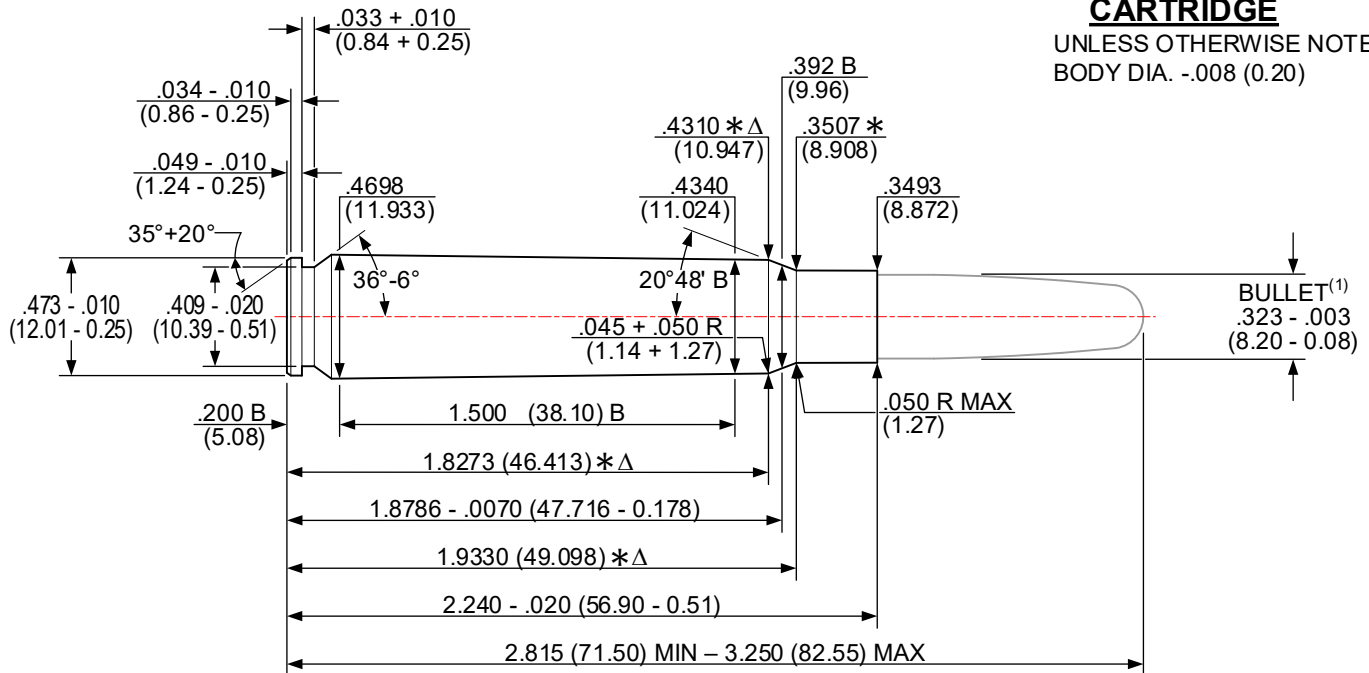

△ 4 GROOVES TWIST: 8.00 (203.2) R.H. OPTIONAL
 △ .098+.002 (2.49+0.05) WIDE MINIMUM BORE & GROOVE AREA: .0532 in² (34.322 mm²)

NOTES:

- B = BASIC (XX.XX) = MILLIMETERS ⊗ = HEADSPACE DIMENSION
- △ = REFERENCE DIMENSION * = DIMENSIONS ARE TO INTERSECTION OF LINES
- ALL CALCULATIONS APPLY AT MAXIMUM MATERIAL CONDITION (MMC)
- (1) – BULLET PROFILE IS SHOWN FOR ILLUSTRATIVE PURPOSES ONLY

DO NOT SCALE FROM DRAWING

ISSUED: 01/14/2013

9.3 X 62 [9.3 X 62]

REVISED: 03/07/2022

CARTRIDGE

UNLESS OTHERWISE NOTED
 BODY DIA. -0.20 (.008)

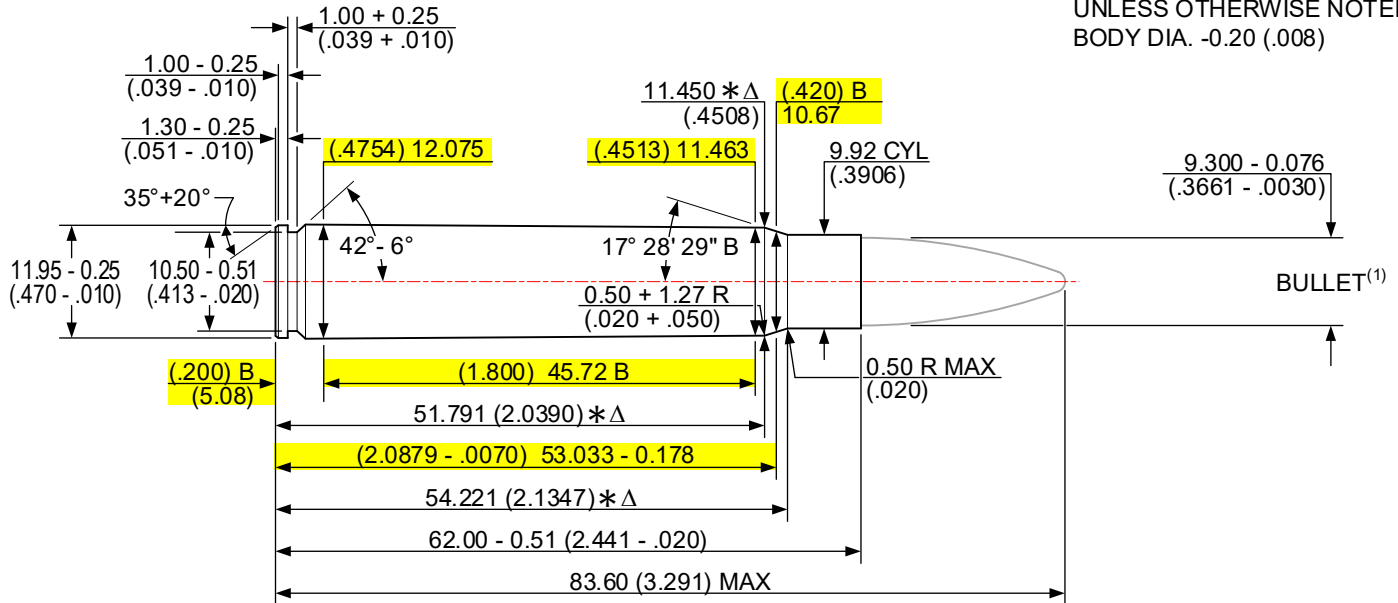

HIGHLIGHTED DIMENSIONS HAVE NO CORRESPONDING C.I.P. ANALOG. THE ENGLISH UNITS FOR THESE ARE THE ORIGINAL VALUES; METRIC VALUES ARE CALCULATED AND ROUNDED.

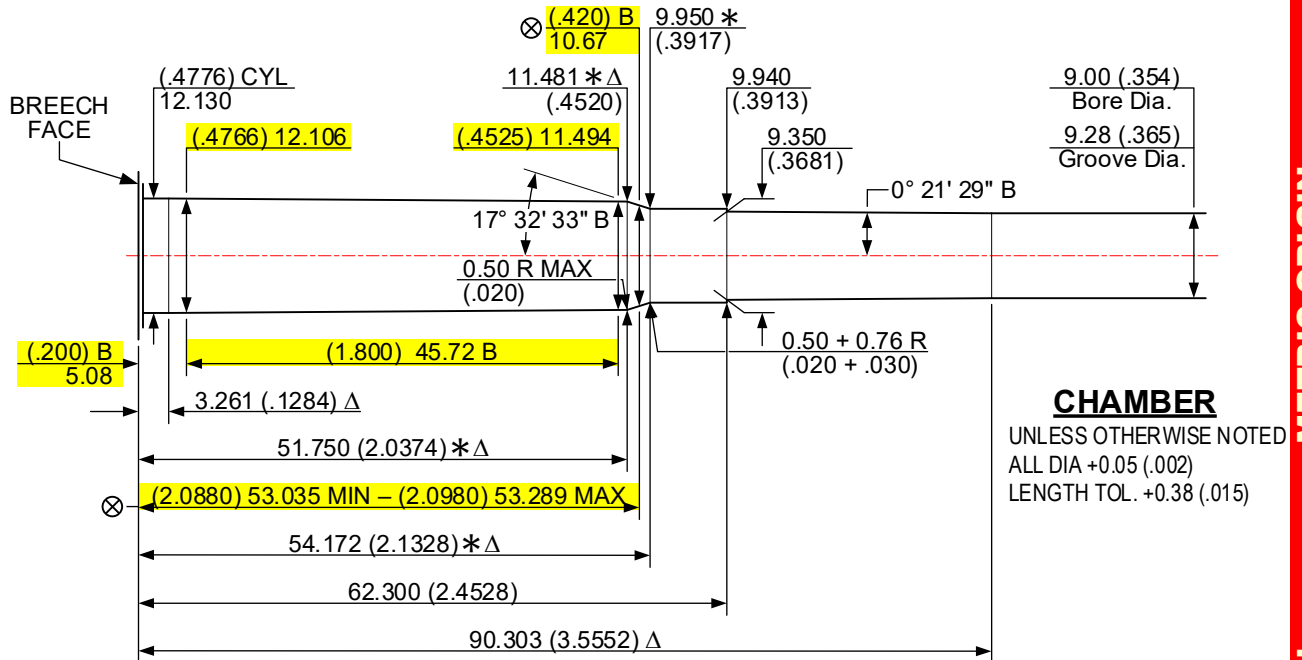

CHAMBER

UNLESS OTHERWISE NOTED
 ALL DIA +0.05 (.002)
 LENGTH TOL. +0.38 (.015)

△ 6 GROOVES TWIST: 360.0 (14.17) R.H. OPTIONAL
 △ 4.60+0.05 (.181+.002) WIDE MINIMUM BORE & GROOVE AREA: 66.317 mm² (.1028 in²)

NOTES:

- B = BASIC (XX.XX) = INCHES ⊗ = HEADSPACE DIMENSION
- △ = REFERENCE DIMENSION * = DIMENSIONS ARE TO INTERSECTION OF LINES
- ALL CALCULATIONS APPLY AT MAXIMUM MATERIAL CONDITION (MMC)
- (1) – BULLET PROFILE IS SHOWN FOR ILLUSTRATIVE PURPOSES ONLY

DO NOT SCALE FROM DRAWING

NOTICE: This drawing is subject to change.
 Revisions, if applicable, are available at www.saami.org.

METRIC ORIGIN

ISSUED: 06/06/2012

17 HORNET [17 HORNET]

REVISED: 02/10/2023

CARTRIDGE

UNLESS OTHERWISE NOTED
 BODY DIA. -.008 (0.20)

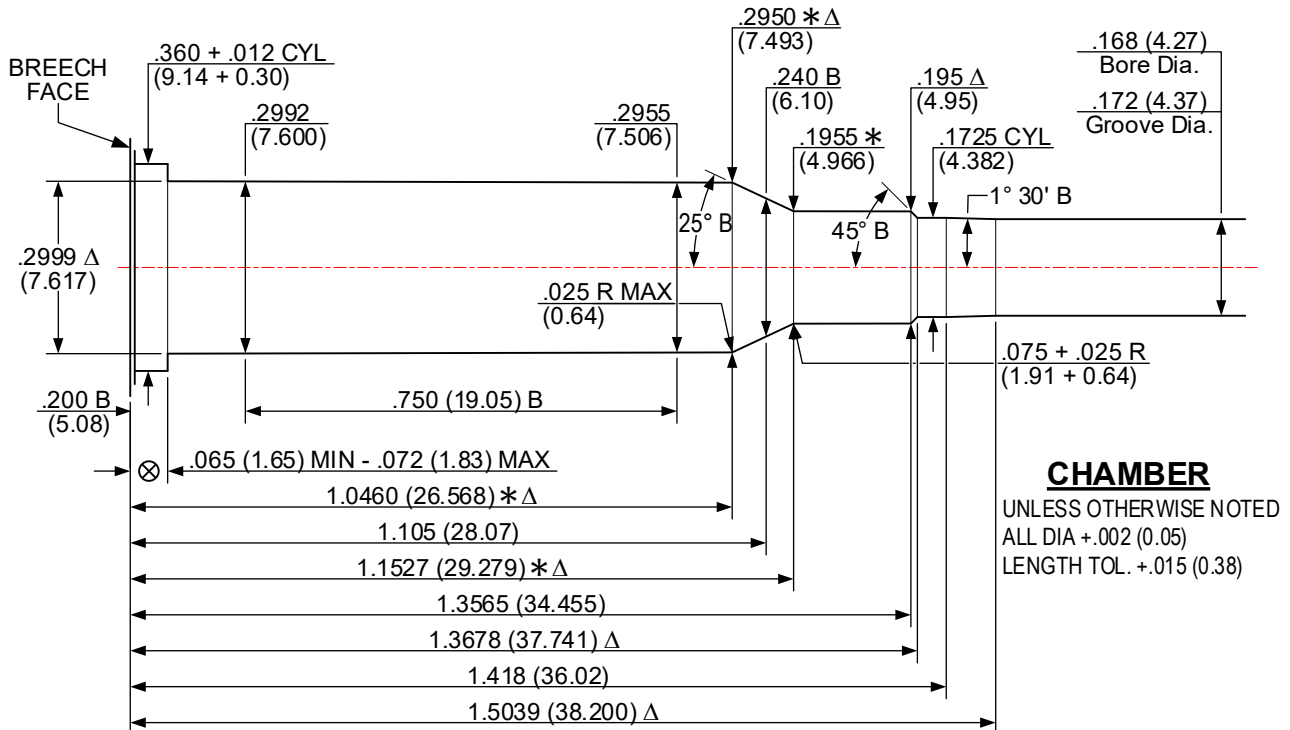
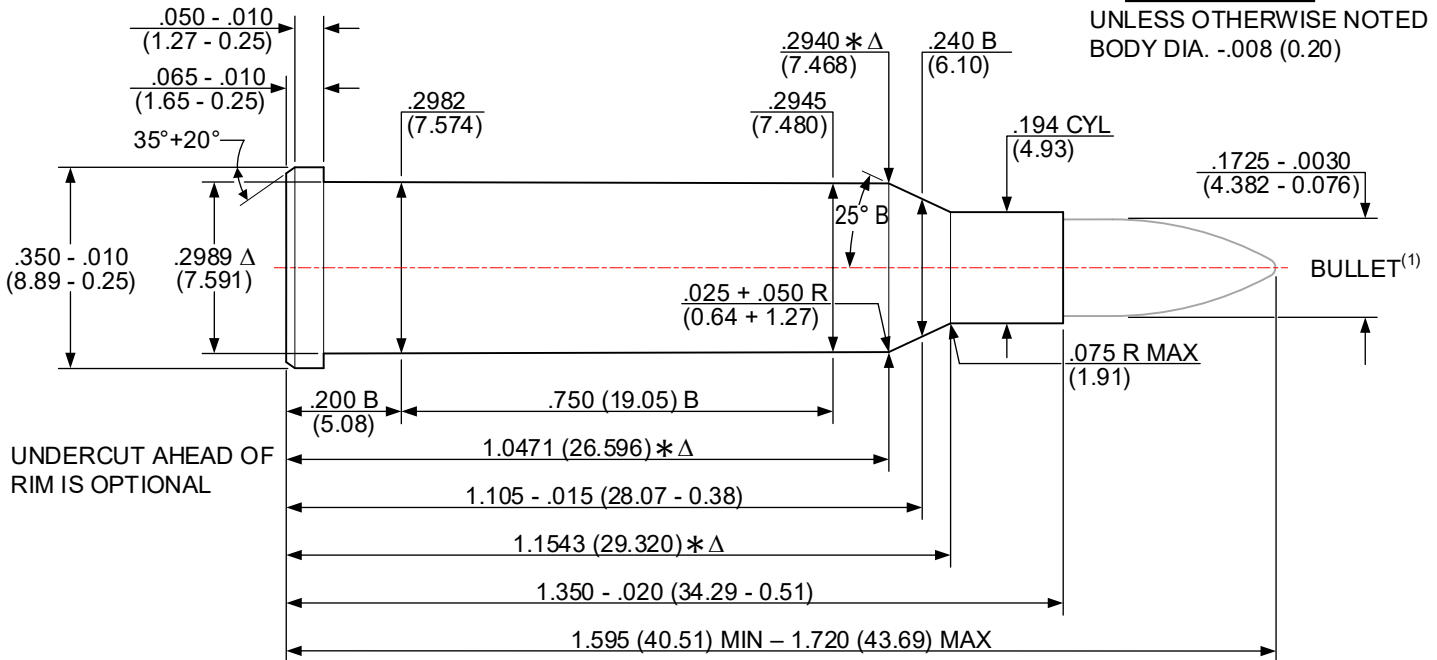

CHAMBER

UNLESS OTHERWISE NOTED
 ALL DIA +.002 (0.05)
 LENGTH TOL. +.015 (0.38)

Δ 6 GROOVES TWIST: 9.00 (228.6) R.H. OPTIONAL
 Δ .062+.002 (1.57+0.05) WIDE MINIMUM BORE & GROOVE AREA: .0229 in² (14.744 mm²)

NOTES:

- B = BASIC (XX.XX) = MILLIMETERS ⊗ = HEAD SPACE DIMENSION
- Δ = REFERENCE DIMENSION * = DIMENSIONS ARE TO INTERSECTION OF LINES
- ALL CALCULATIONS APPLY AT MAXIMUM MATERIAL CONDITION (MMC)
- (1) – BULLET PROFILE IS SHOWN FOR ILLUSTRATIVE PURPOSES ONLY

DO NOT SCALE FROM DRAWING

NOTICE: This drawing is subject to change.
 Revisions, if applicable, are available at www.saami.org.

ISSUED: 04/21/1980

17 REMINGTON [17 REM]

REVISED: 03/16/2022

CARTRIDGE

UNLESS OTHERWISE NOTED
 BODY DIA. -.008 (0.20)

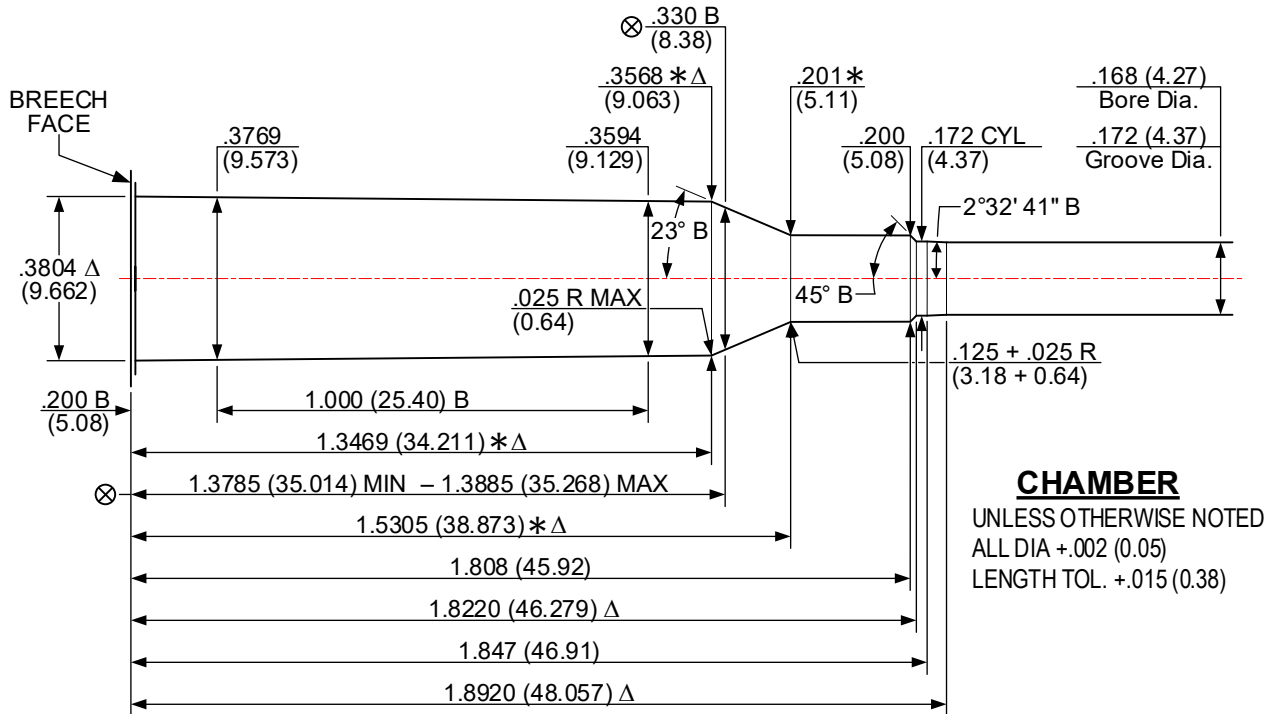
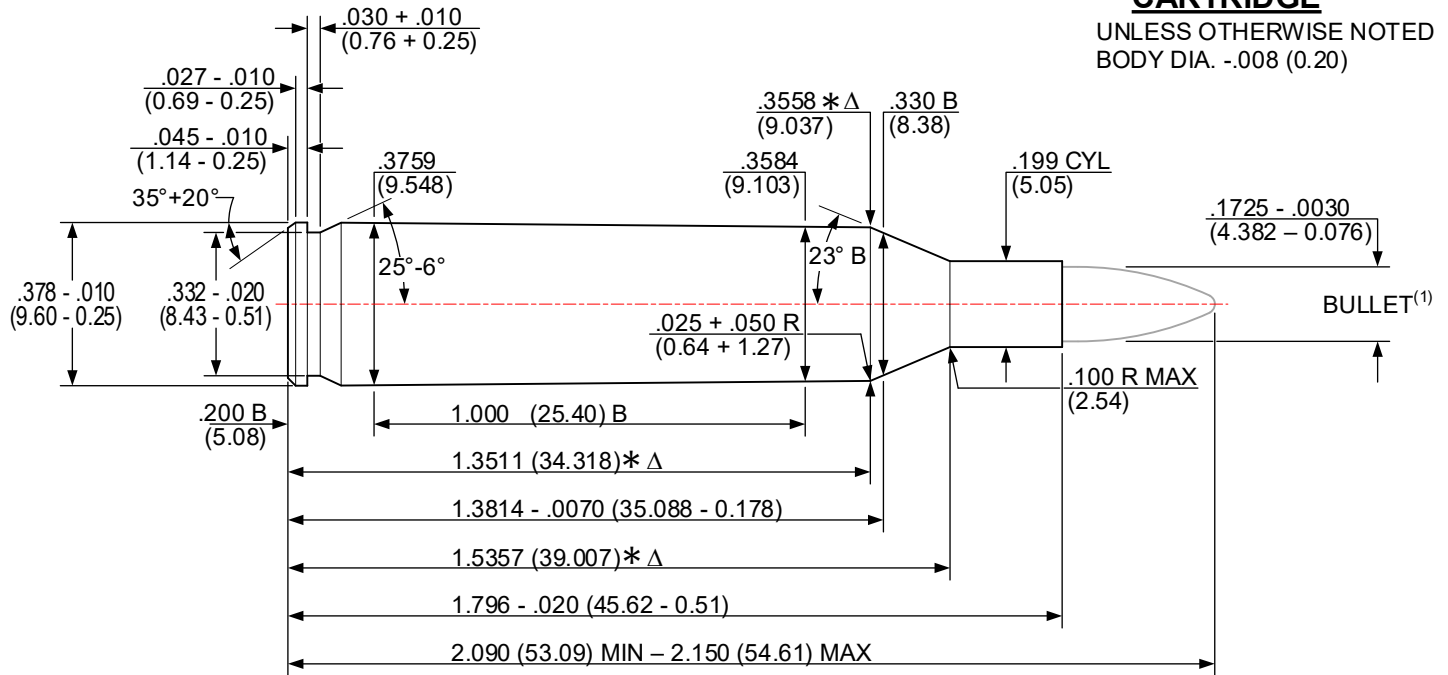

CHAMBER

UNLESS OTHERWISE NOTED
 ALL DIA +.002 (0.05)
 LENGTH TOL. +.015 (0.38)

Δ 6 GROOVES TWIST: 9.00 [228.6] R.H. OPTIONAL
 Δ .062+.002 [1.57+0.05] WIDE MINIMUM BORE & GROOVE AREA: .0229 in² (14.774 mm²)

NOTES:

- B = BASIC
- Δ = REFERENCE DIMENSION
- ALL CALCULATIONS APPLY AT MAXIMUM MATERIAL CONDITION (MMC)
- (1) – BULLET PROFILE IS SHOWN FOR ILLUSTRATIVE PURPOSES ONLY
- (XX.XX) = MILLIMETERS
- * = DIMENSIONS ARE TO INTERSECTION OF LINES
- ⊗ = HEAD SPACE DIMENSION

DO NOT SCALE FROM DRAWING

ISSUED: 06/13/2007 **17 REMINGTON FIREBALL [17 REM FIREBALL]** REVISED: 03/17/2022

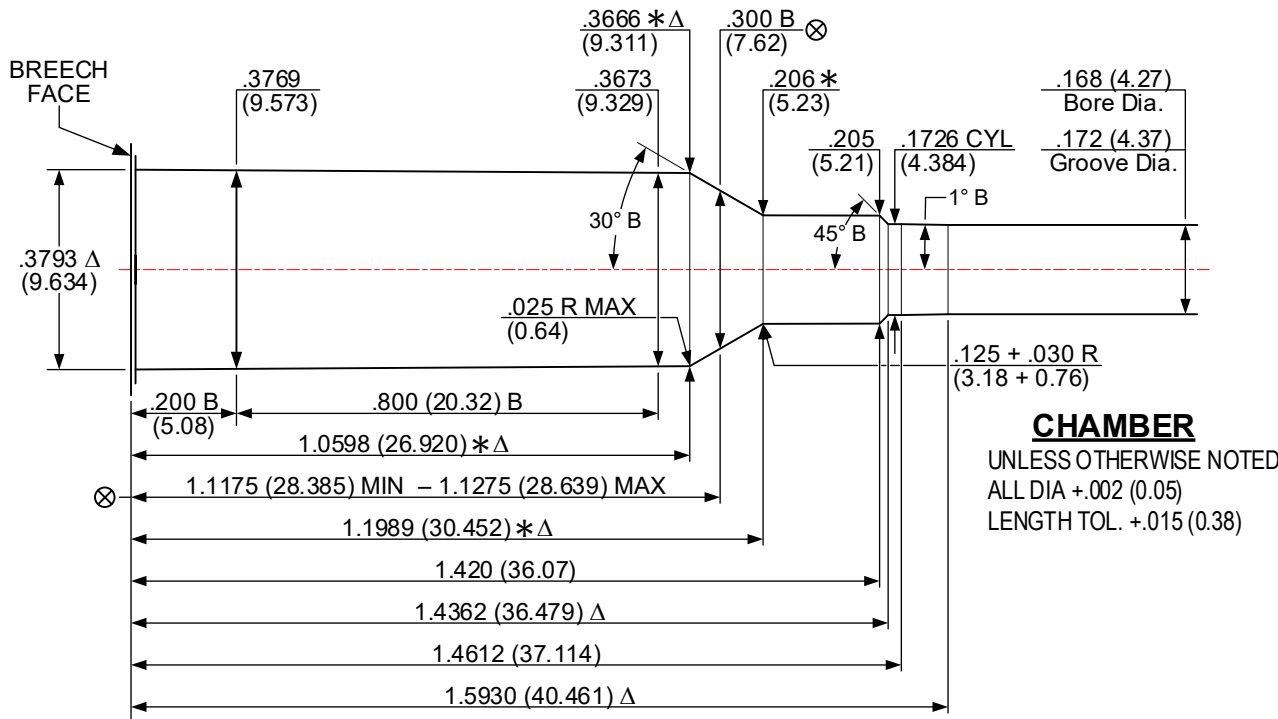
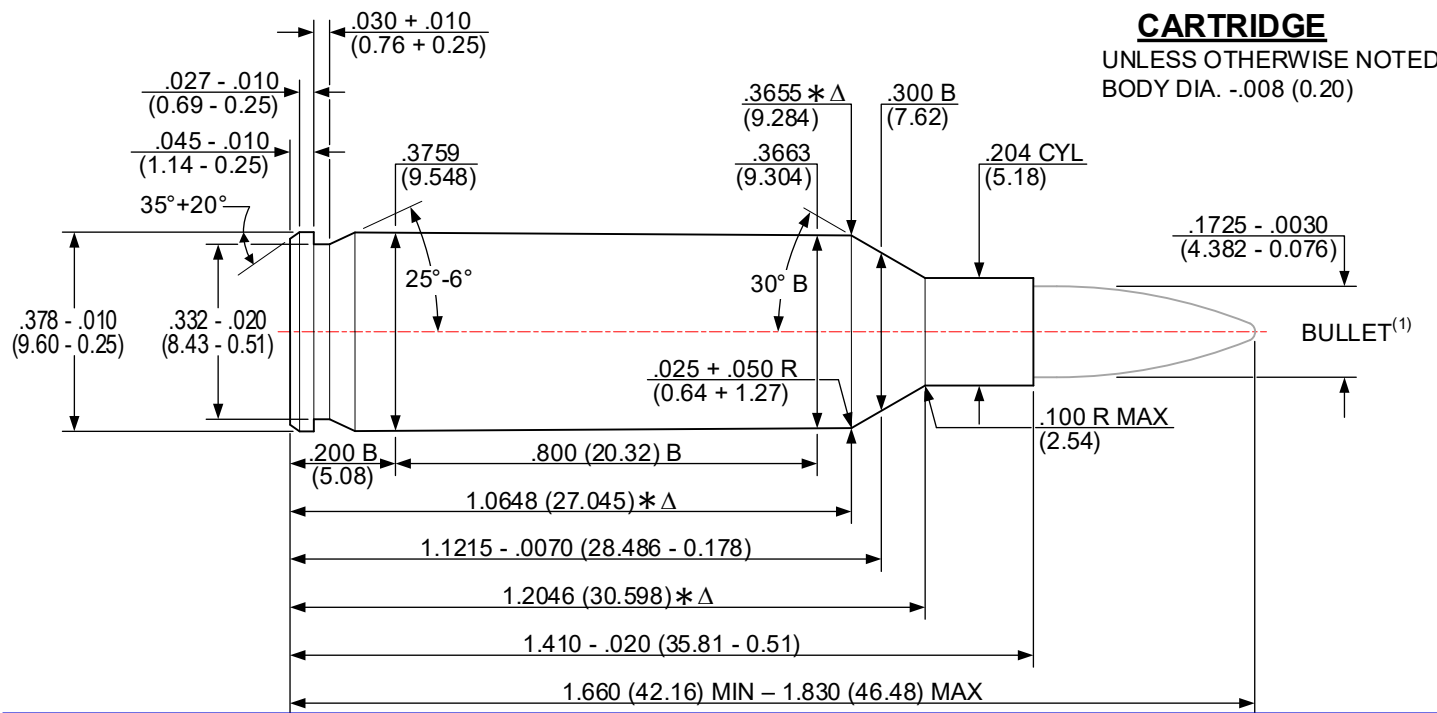

Δ 6 GROOVES TWIST: 9.00 (228.6) R.H. OPTIONAL
 Δ .062+.002 (1.57+0.05) WIDE MINIMUM BORE & GROOVE AREA: .0229 in² (14.774 mm²)

NOTES:

- B = BASIC
- Δ = REFERENCE DIMENSION
- ALL CALCULATIONS APPLY AT MAXIMUM MATERIAL CONDITION (MMC)
- (1) – BULLET PROFILE IS SHOWN FOR ILLUSTRATIVE PURPOSES ONLY
- (XX.XX) = MILLIMETERS
- * = DIMENSIONS ARE TO INTERSECTION OF LINES
- ⊗ = HEAD SPACE DIMENSION

DO NOT SCALE FROM DRAWING

NOTICE: This drawing is subject to change.
 Revisions, if applicable, are available at www.saami.org.

ISSUED: 06/23/2004

204 RUGER [204 RUGER]

REVISED: 04/24/2023

CARTRIDGE

UNLESS OTHERWISE NOTED
 BODY DIA. -.008 (0.20)

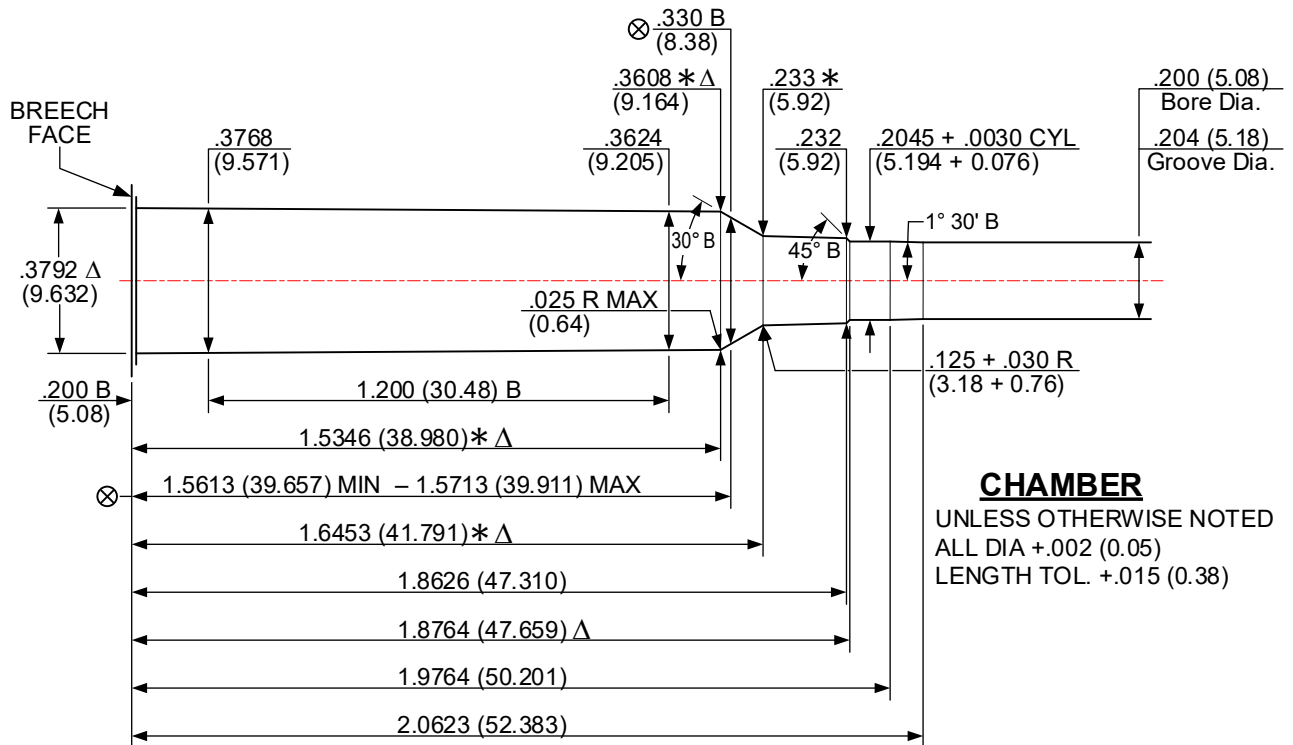
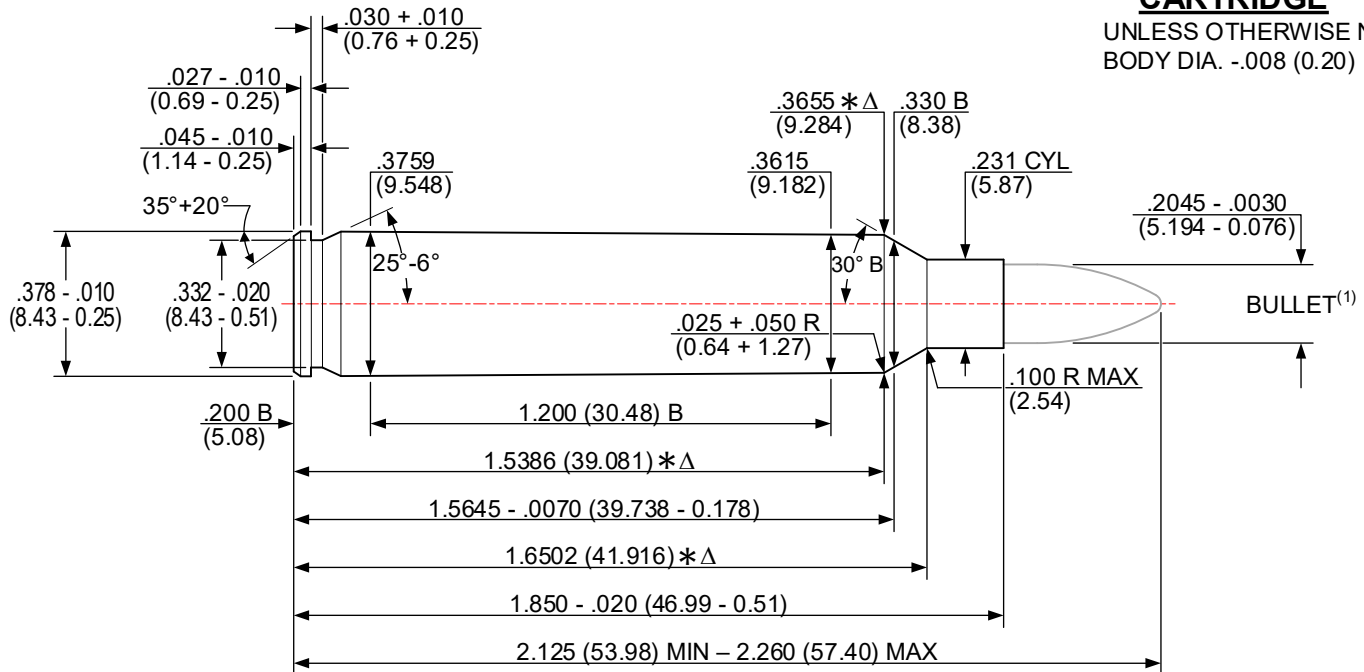

CHAMBER

UNLESS OTHERWISE NOTED
 ALL DIA +.002 (0.05)
 LENGTH TOL. +.015 (0.38)

Δ 6 GROOVES TWIST: 12.00 (304.8) R.H. OPTIONAL
 Δ .054+.002 (1.37+0.05) WIDE MINIMUM BORE & GROOVE AREA: .0321 in² (20.710 mm²)

NOTES:

- B = BASIC (XX.XX) = MILLIMETERS ⊗ = HEAD SPACE DIMENSION
- Δ = REFERENCE DIMENSION * = DIMENSIONS ARE TO INTERSECTION OF LINES
- ALL CALCULATIONS APPLY AT MAXIMUM MATERIAL CONDITION (MMC)
- (1) – BULLET PROFILE IS SHOWN FOR ILLUSTRATIVE PURPOSES ONLY

DO NOT SCALE FROM DRAWING

ISSUED: 05/29/1979 **218 BEE [218 BEE]** REVISED: 02/10/2023

CARTRIDGE
 UNLESS OTHERWISE NOTED
 BODY DIA. -.008 (0.20)

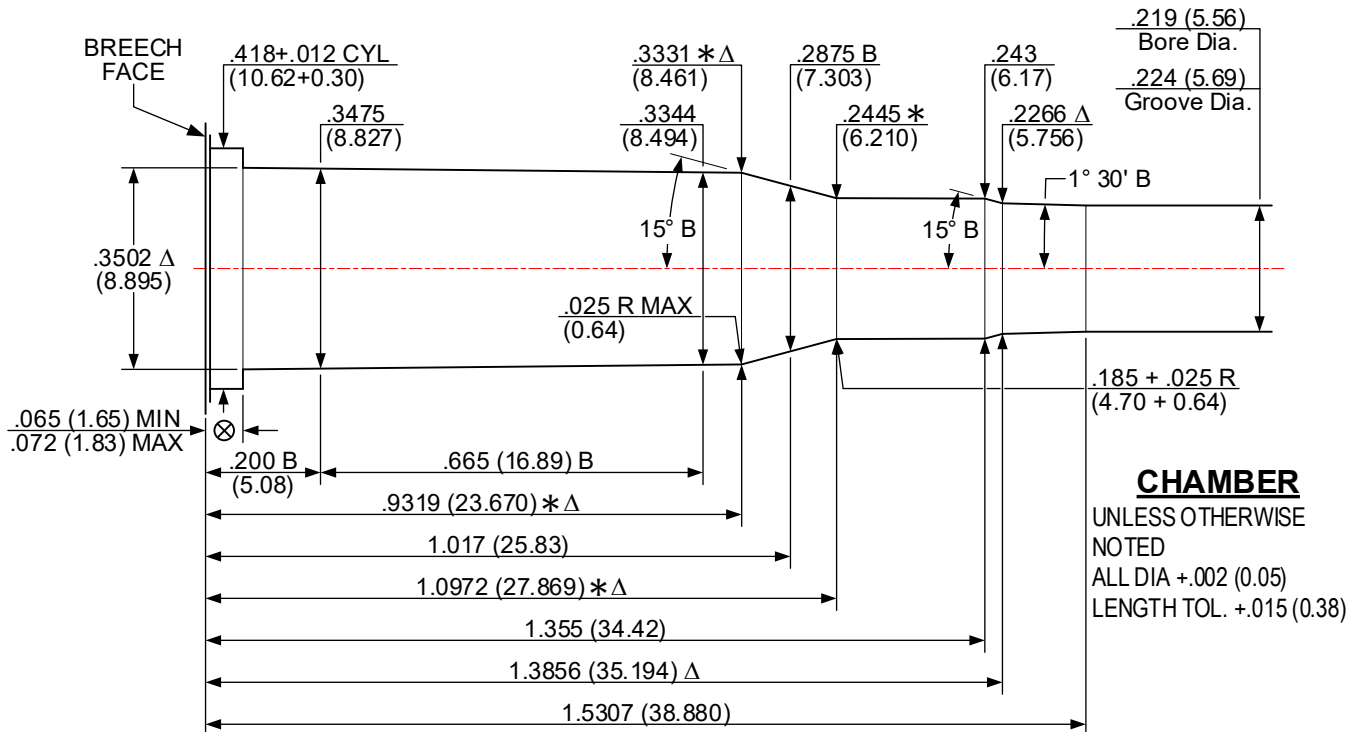
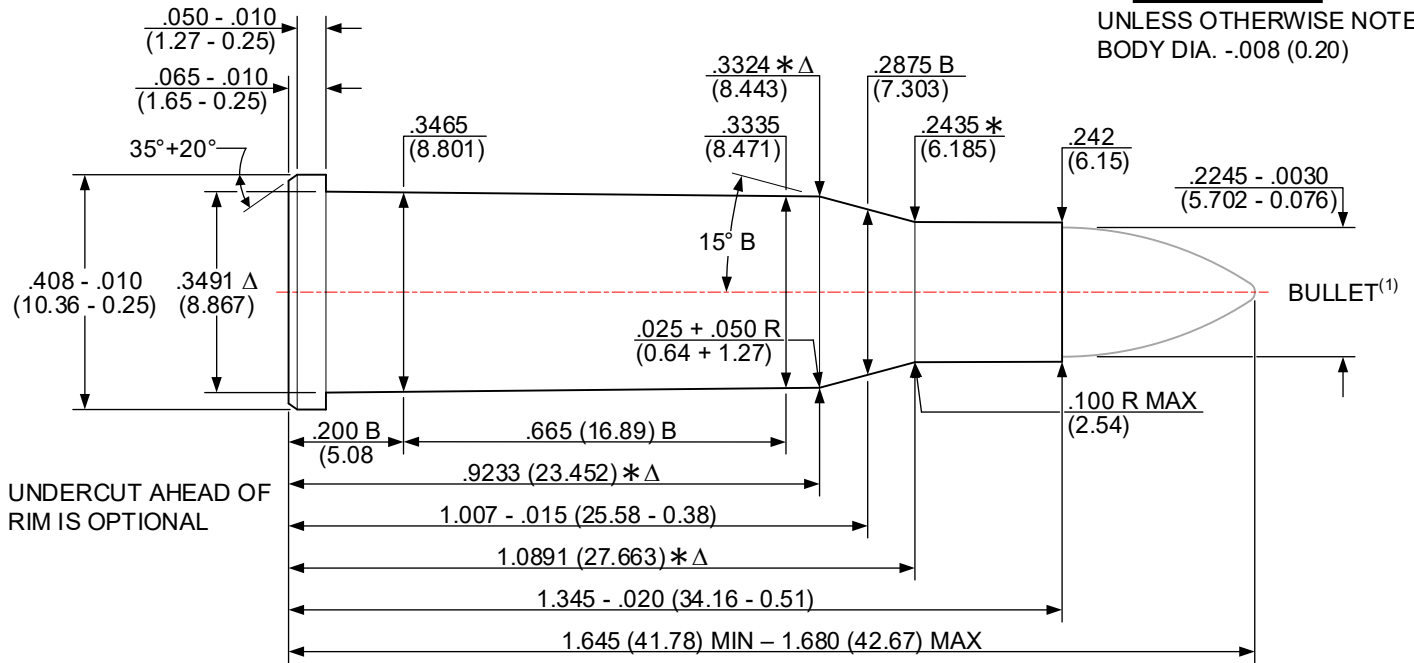

CHAMBER
 UNLESS OTHERWISE NOTED
 ALL DIA +.002 (0.05)
 LENGTH TOL. +.015 (0.38)

Δ 6 GROOVES TWIST: 16.00 (406.4) R.H. OPTIONAL
 Δ .074+.002 (1.88+0.05) WIDE MINIMUM BORE & GROOVE AREA: .0388 in² (25.032 mm²)

NOTES:

- B = BASIC (XX.XX) = MILLIMETERS ⊗ = HEAD SPACE DIMENSION
- Δ = REFERENCE DIMENSION * = DIMENSIONS ARE TO INTERSECTION OF LINES
- ALL CALCULATIONS APPLY AT MAXIMUM MATERIAL CONDITION (MMC)
- (1) – BULLET PROFILE IS SHOWN FOR ILLUSTRATIVE PURPOSES ONLY

DO NOT SCALE FROM DRAWING

NOTICE: This drawing is subject to change.
 Revisions, if applicable, are available at www.saami.org.

ISSUED: 01/21/2024 **22 ADVANCED RIFLE CARTRIDGE [22 ARC]** **REVISED: - / - / - - -**

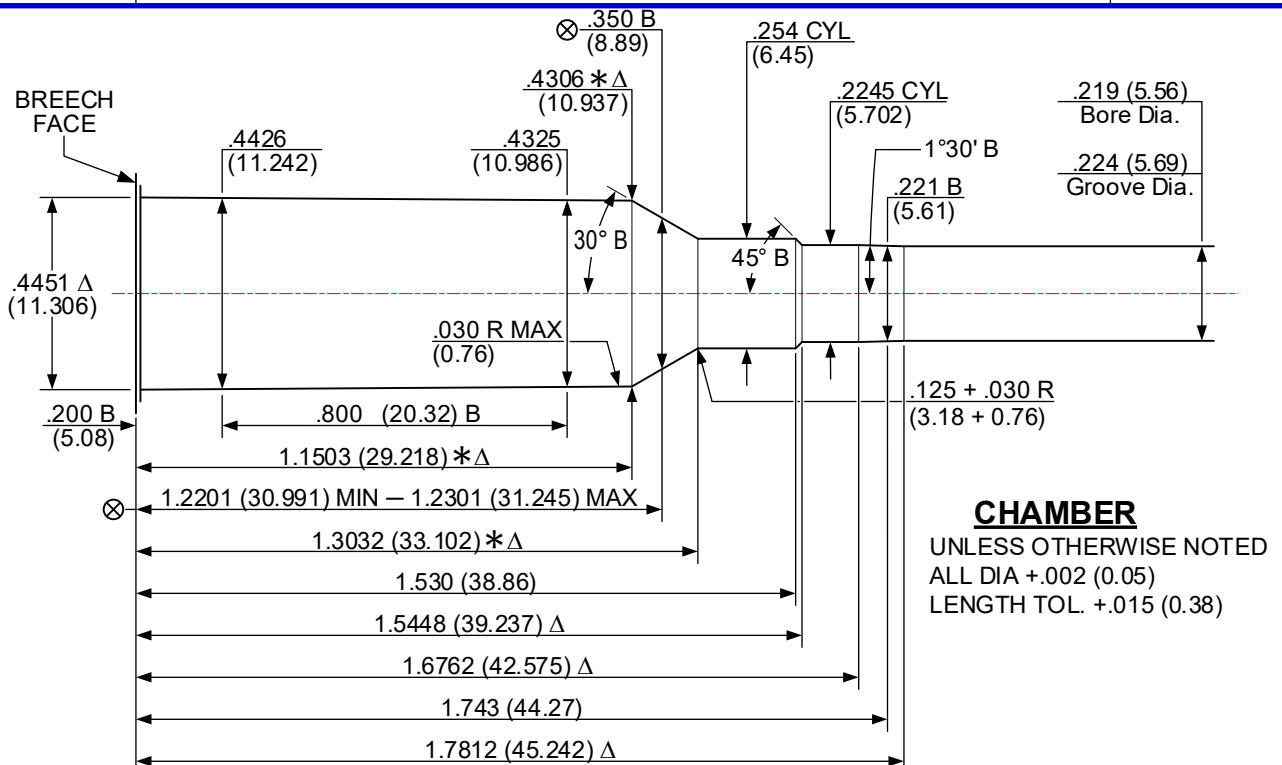
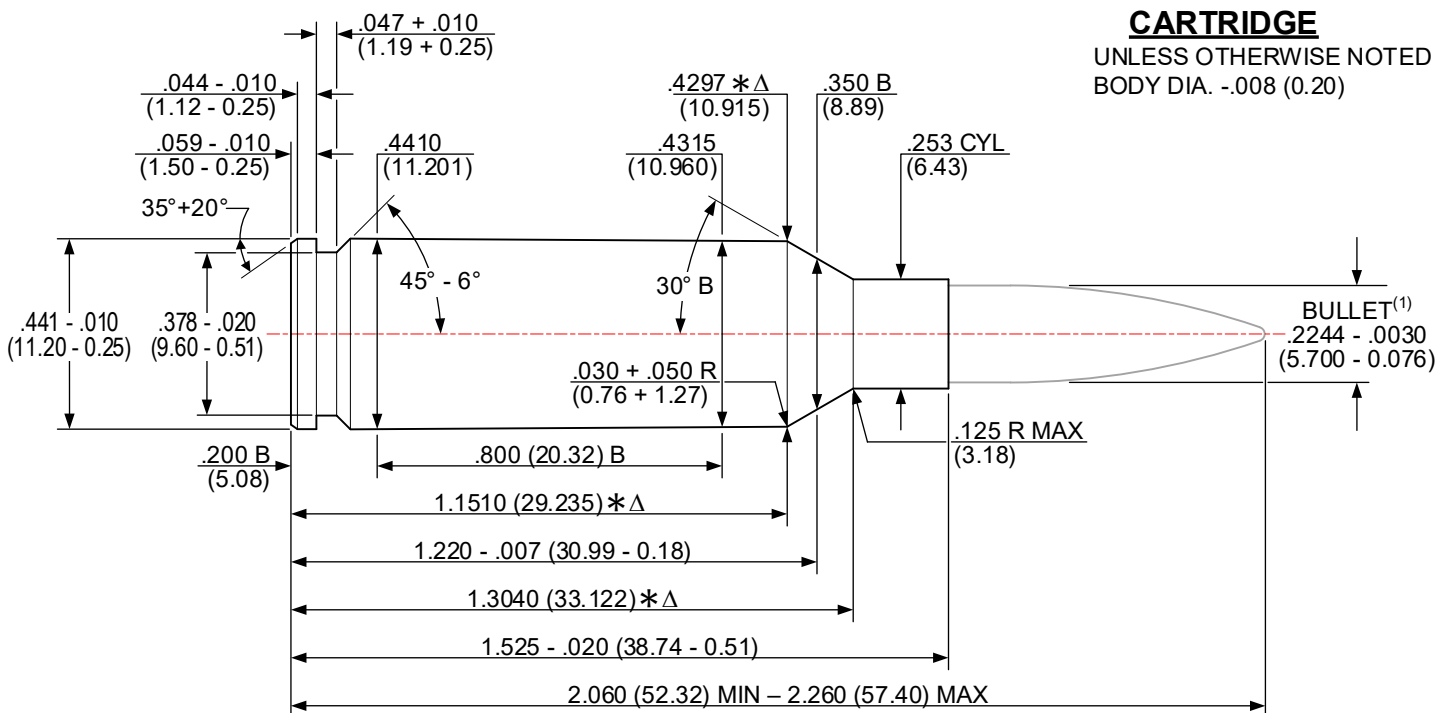

Δ 6 GROOVES

TWIST: 7.00 (177.8) R.H. OPTIONAL

NOTE:

Δ .074+.002 (1.88+0.05) WIDE

MINIMUM BORE & GROOVE AREA: .0388 in² (25.032 mm²)

B = BASIC

(XX.XX) = MILLIMETERS

⊗ = HEADSPACE DIMENSION

Δ = REFERENCE DIMENSION

* = DIMENSIONS ARE TO INTERSECTION OF LINES

ALL CALCULATIONS APPLY AT MAXIMUM MATERIAL CONDITION (MMC)

(1) – BULLET PROFILE IS SHOWN FOR ILLUSTRATIVE PURPOSES ONLY

DO NOT SCALE FROM DRAWING

ISSUED: 01/21/2024 **22 CREEDMOOR [22 CM]** **REVISED: -/-/-/-**

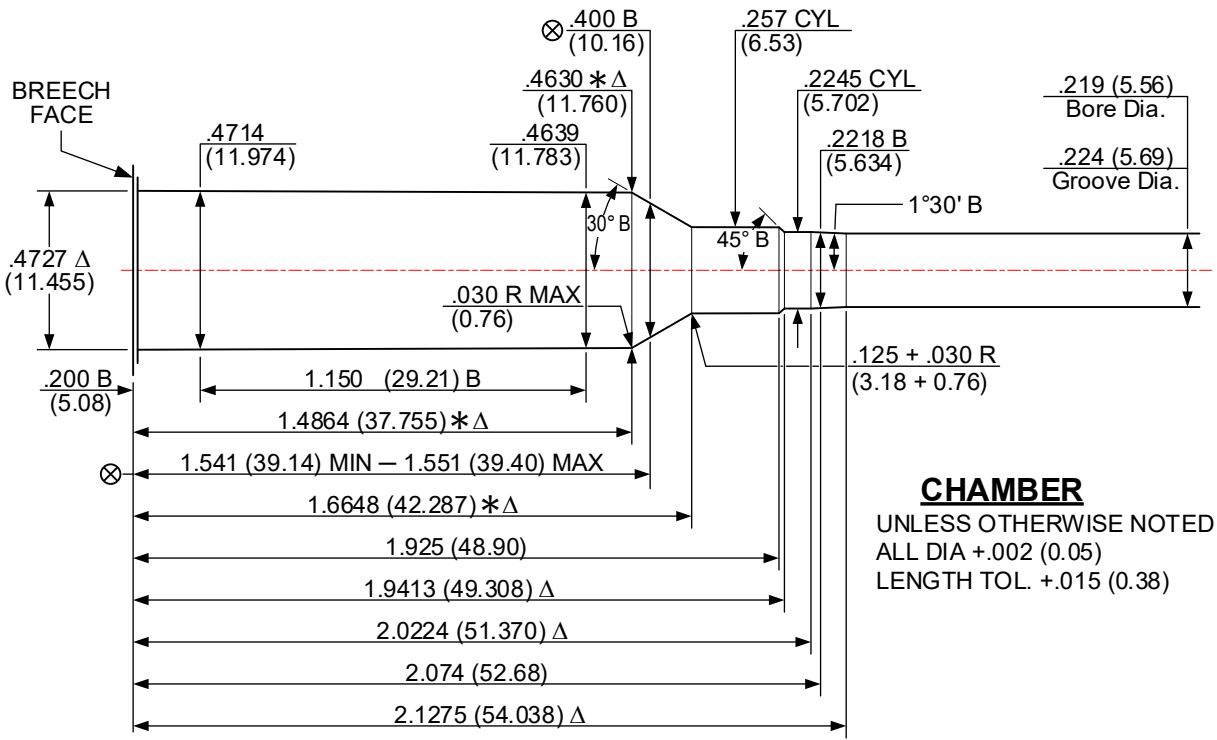
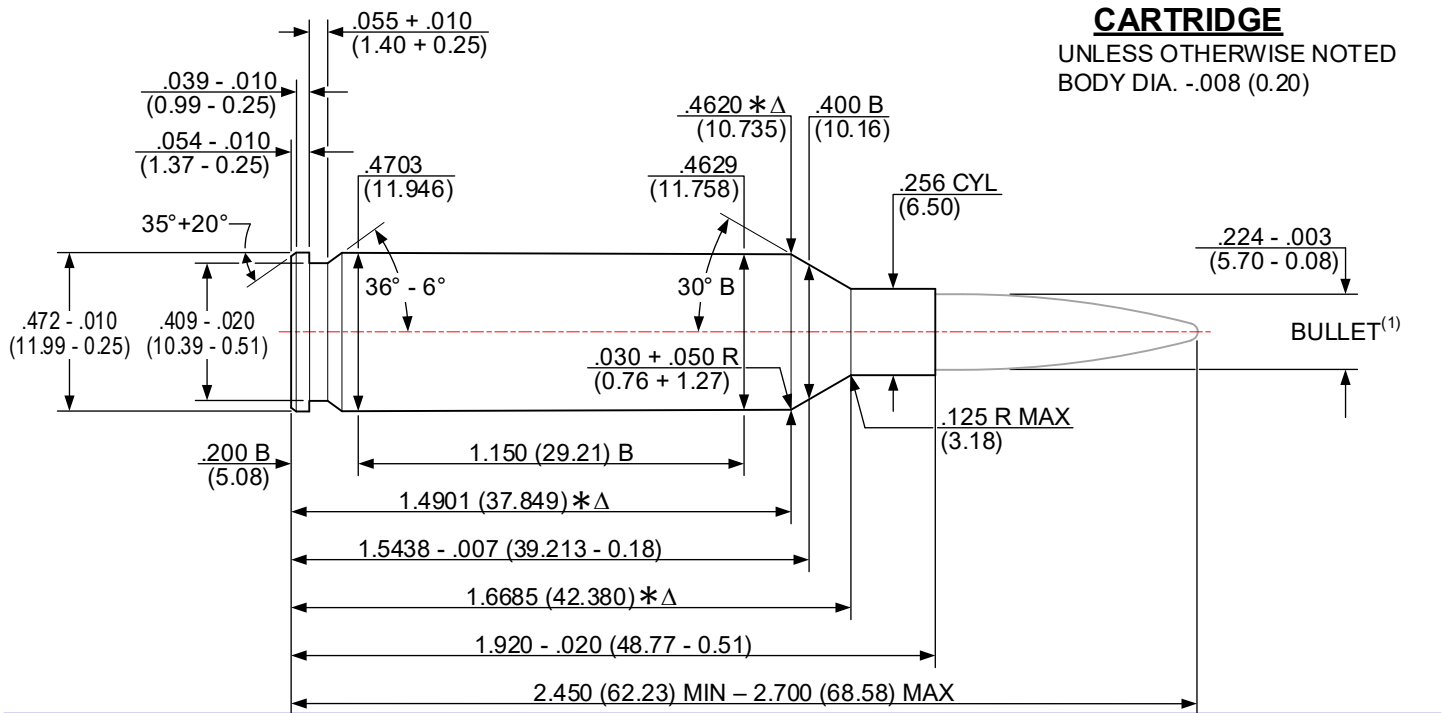

Δ 6 GROOVES TWIST: 8.00 (203.2) R.H. OPTIONAL
 NOTE: Δ .074+.002 (1.88+0.05) WIDE MINIMUM BORE & GROOVE AREA: .0388 in² (25.032 mm²)
 B = BASIC (XX.XX) = MILLIMETERS ⊗ = HEADSPACE DIMENSION
 Δ = REFERENCE DIMENSION * = DIMENSIONS ARE TO INTERSECTION OF LINES
 ALL CALCULATIONS APPLY AT MAXIMUM MATERIAL CONDITION (MMC)
 (1) – BULLET PROFILE IS SHOWN FOR ILLUSTRATIVE PURPOSES ONLY

DO NOT SCALE FROM DRAWING

ISSUED: 05/29/1979

22 HORNET [22 HORNET]

REVISED: 02/10/2023

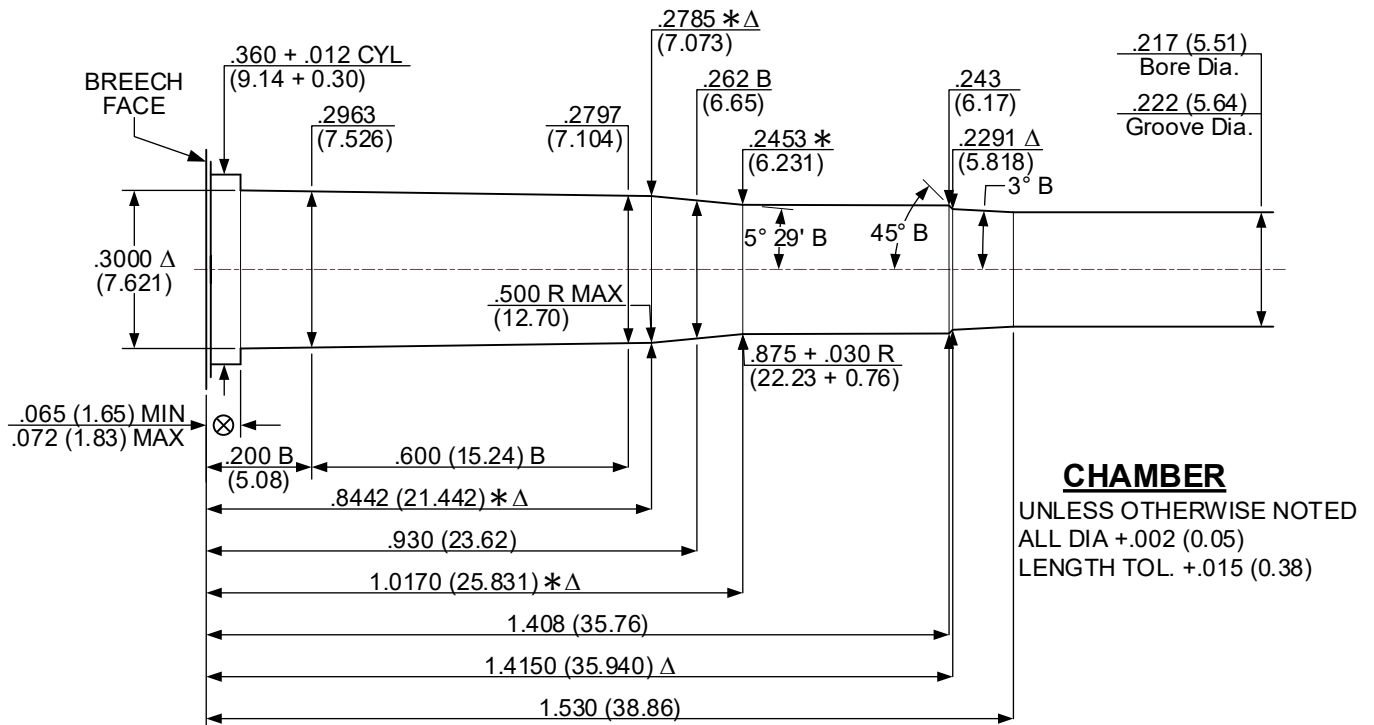
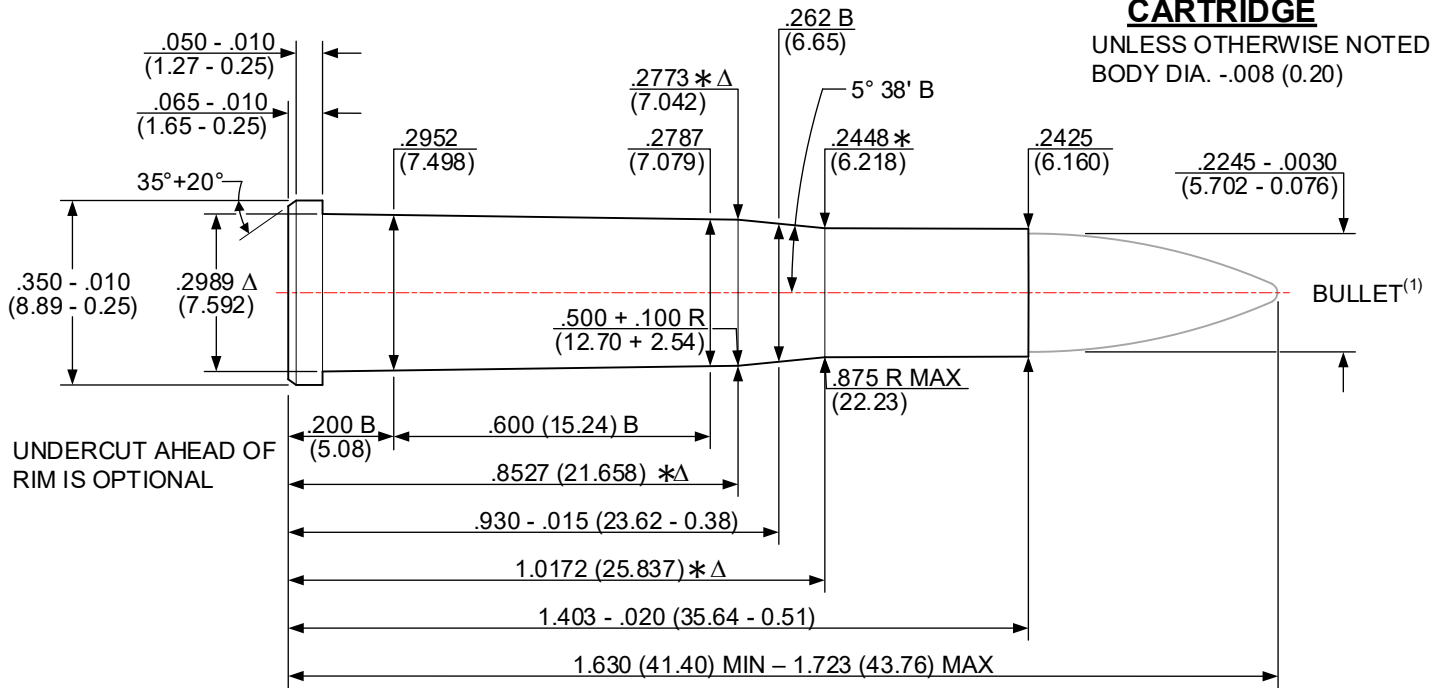

Δ 6 GROOVES TWIST: 16.00 [406.4] R.H. OPTIONAL
 Δ .068+.002 [1.73+0.05] WIDE MINIMUM BORE & GROOVE AREA: .0380 in² [24.516 mm²]

NOTES:

- B = BASIC (XX.XX) = MILLIMETERS ⊗ = HEAD SPACE DIMENSION
- Δ = REFERENCE DIMENSION * = DIMENSIONS ARE TO INTERSECTION OF LINES
- ALL CALCULATIONS APPLY AT MAXIMUM MATERIAL CONDITION (MMC)
- (1) – BULLET PROFILE IS SHOWN FOR ILLUSTRATIVE PURPOSES ONLY

DO NOT SCALE FROM DRAWING

NOTICE: This drawing is subject to change.
 Revisions, if applicable, are available at www.saami.org.

ISSUED: 01/17/2017 **22 NOSLER [22 NOSLER]** REVISED: 03/29/2022

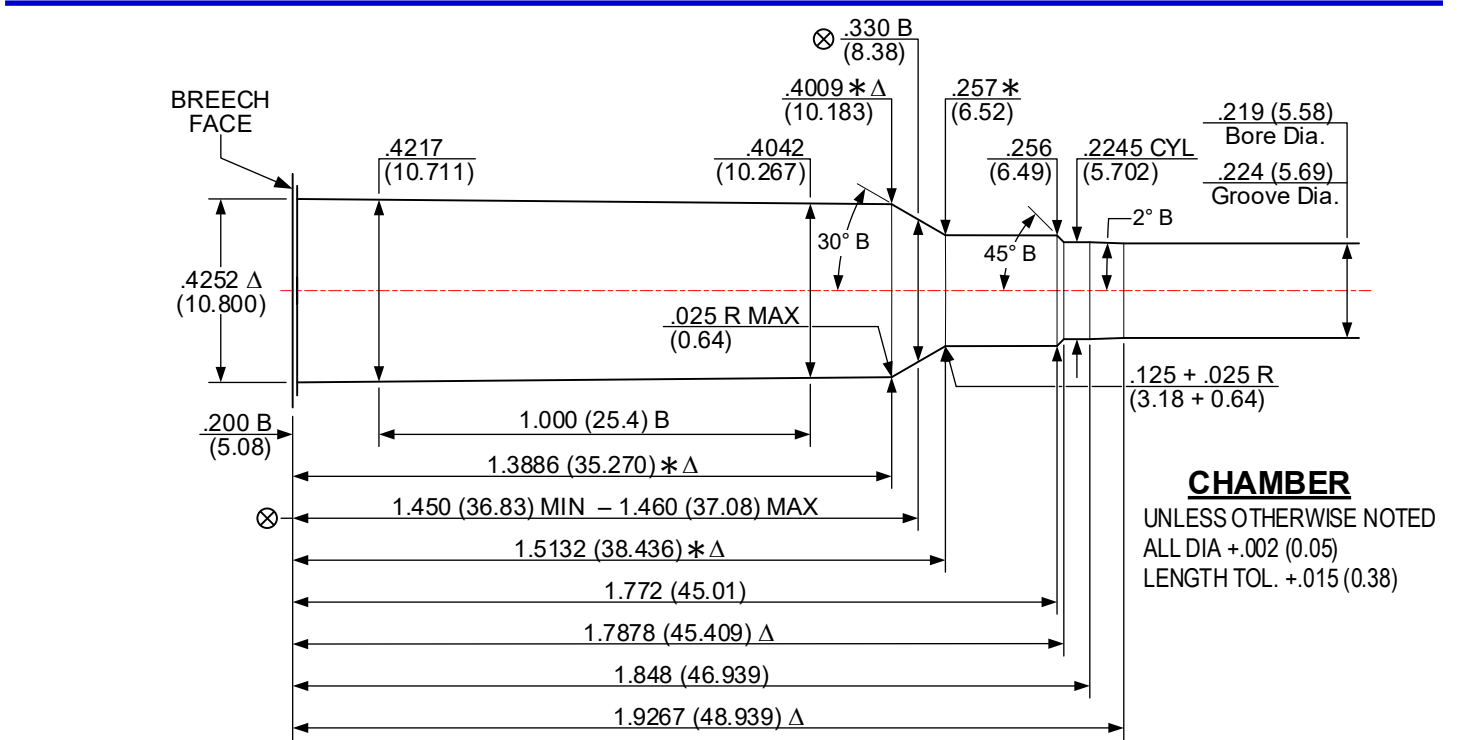
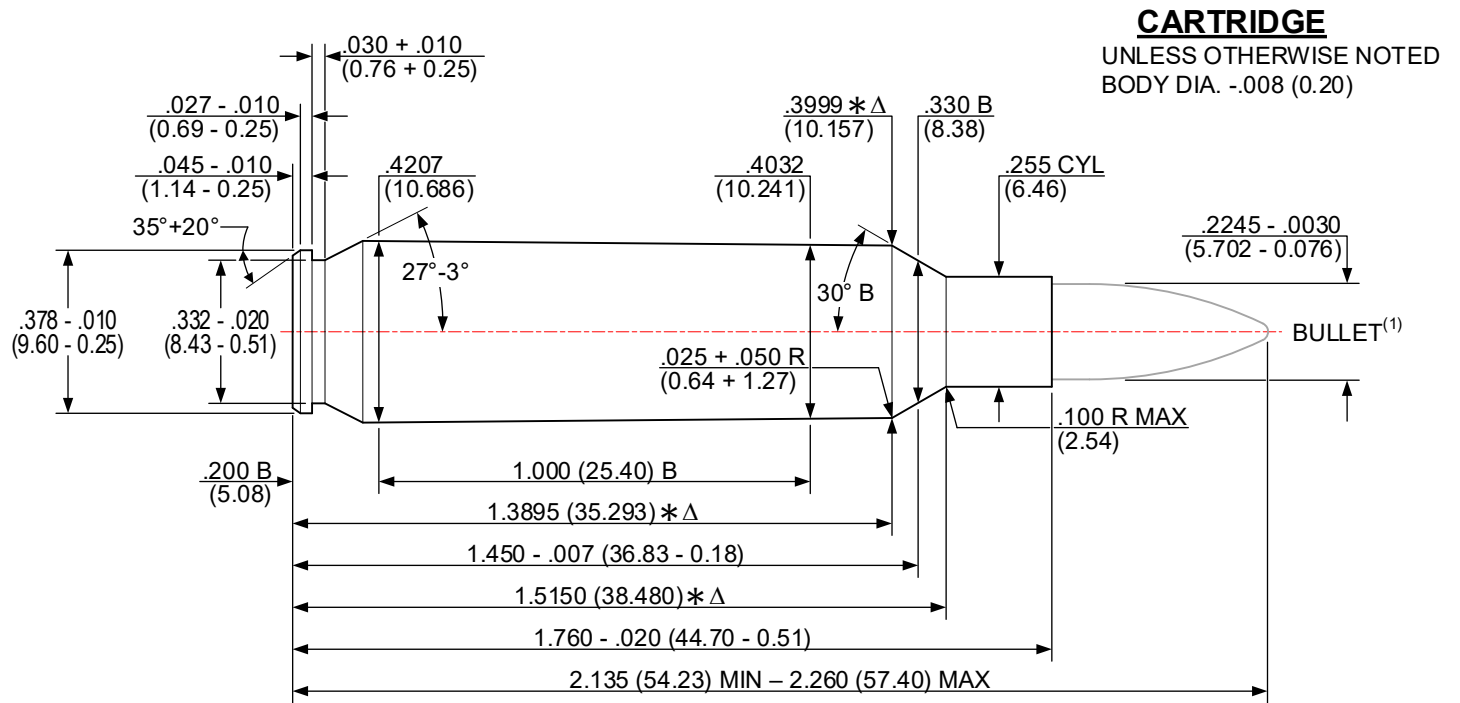

Δ 6 GROOVES TWIST: 8.00 (203.2) R.H. OPTIONAL
 Δ .074+.002 (1.88+0.05) WIDE MINIMUM BORE & GROOVE AREA: .0388 in² (25.032 mm²)

NOTES:
 B = BASIC (XX.XX) = MILLIMETERS ⊗ = HEADSPACE DIMENSION
 Δ = REFERENCE DIMENSION * = DIMENSIONS ARE TO INTERSECTION OF LINES
 ALL CALCULATIONS APPLY AT MAXIMUM MATERIAL CONDITION (MMC)
 (1) - BULLET PROFILE IS SHOWN FOR ILLUSTRATIVE PURPOSES ONLY

DO NOT SCALE FROM DRAWING

NOTICE: This drawing is subject to change.
 Revisions, if applicable, are available at www.saami.org.

ISSUED: 05/29/1979 **22-250 REMINGTON [22-250 REM]** REVISED: 03/30/2022

CARTRIDGE

UNLESS OTHERWISE NOTED
 BODY DIA. -.008 (0.20)

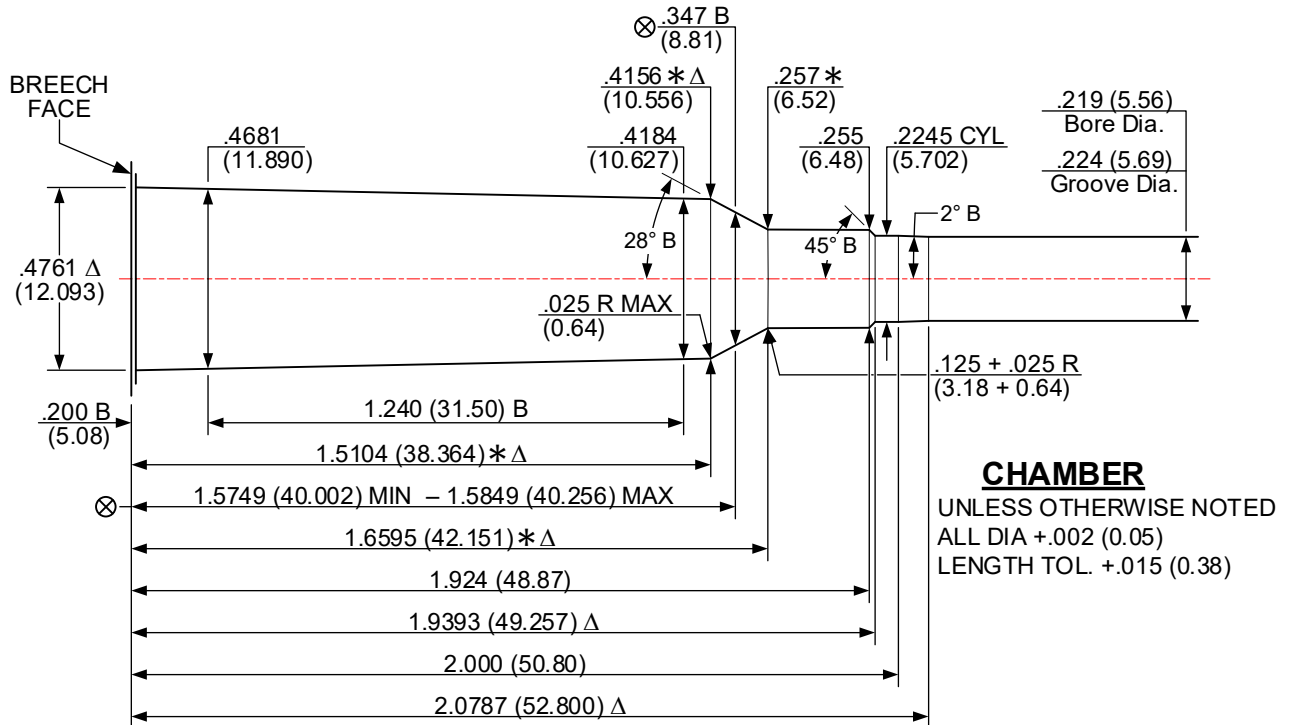
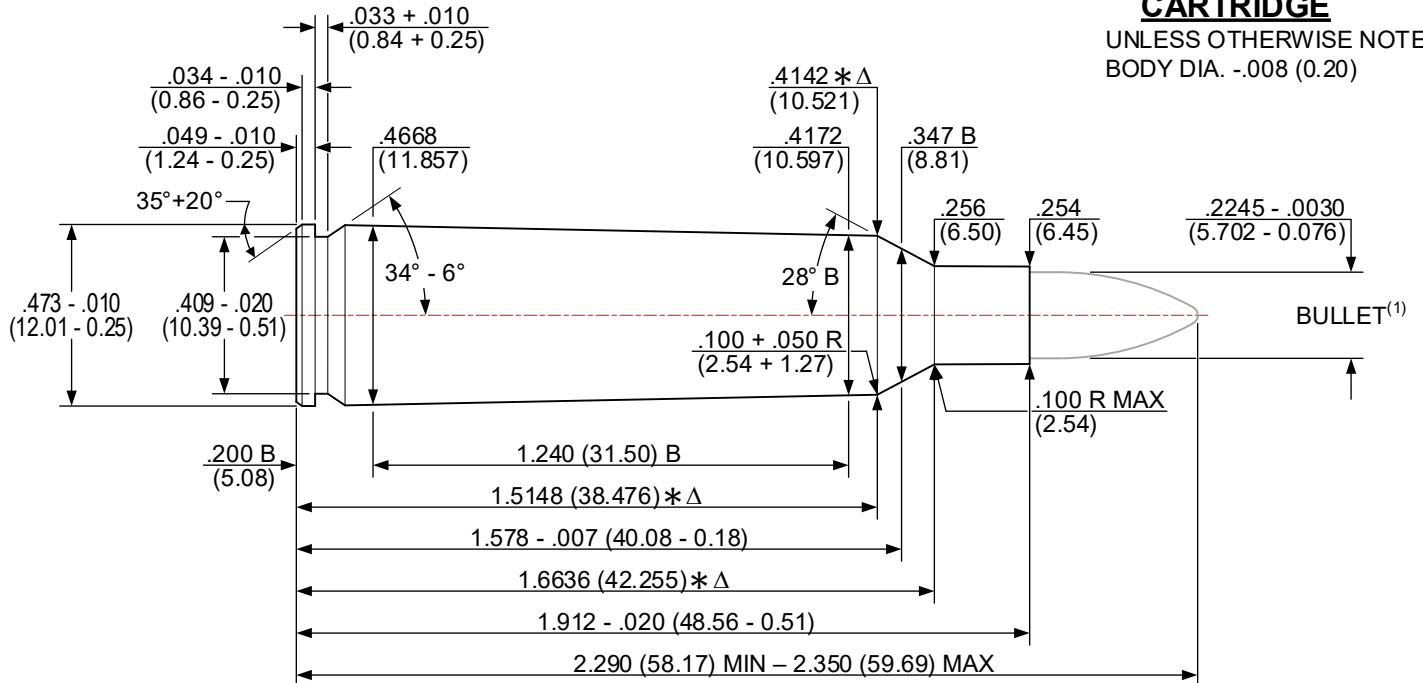

Δ 6 GROOVES TWIST: 14.00 (355.6) R.H. OPTIONAL
 Δ .080+.002 (2.03+0.05) WIDE MINIMUM BORE & GROOVE AREA: .0388 in² (25.032 mm²)

NOTES:

- B = BASIC (XX.XX) = MILLIMETERS \varnothing = HEADSPACE DIMENSION
- Δ = REFERENCE DIMENSION * = DIMENSIONS ARE TO INTERSECTION OF LINES
- ALL CALCULATIONS APPLY AT MAXIMUM MATERIAL CONDITION (MMC)
- (1) – BULLET PROFILE IS SHOWN FOR ILLUSTRATIVE PURPOSES ONLY

DO NOT SCALE FROM DRAWING

ISSUED: 08/01/1988 **220 SWIFT [220 SWIFT]** REVISED: 03/30/2022

CARTRIDGE

UNLESS OTHERWISE NOTED
 BODY DIA. -.008 (0.20)

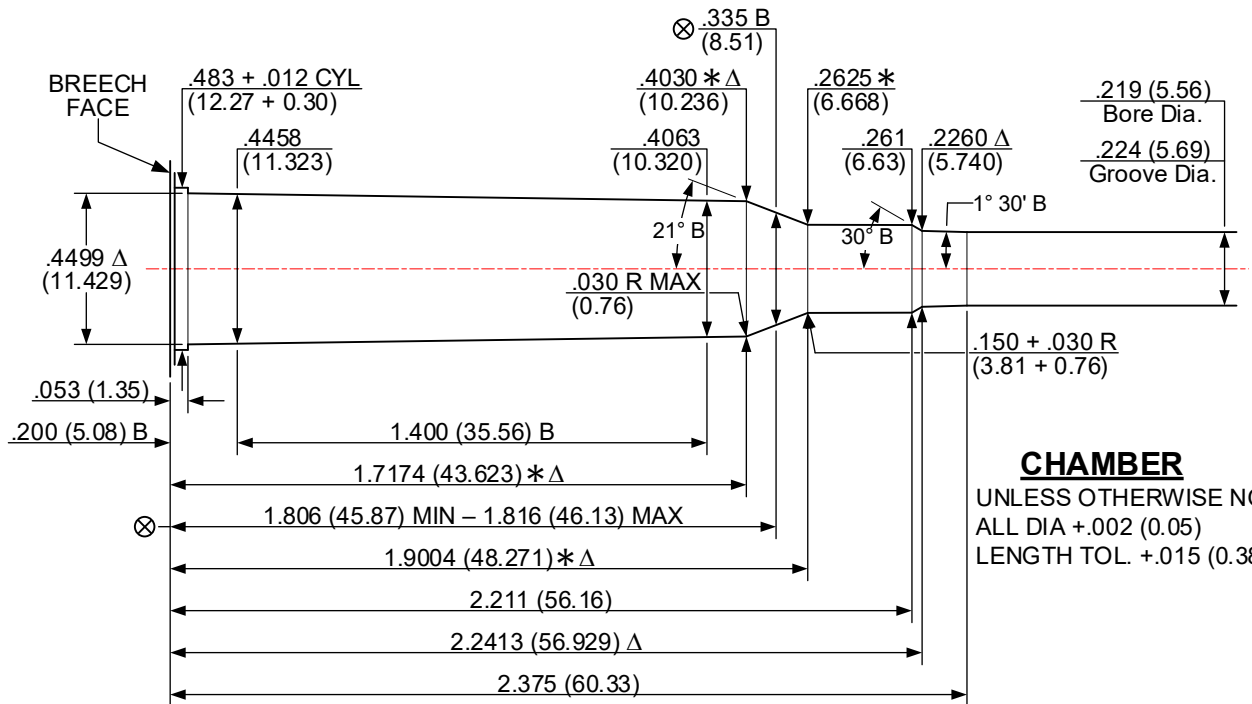
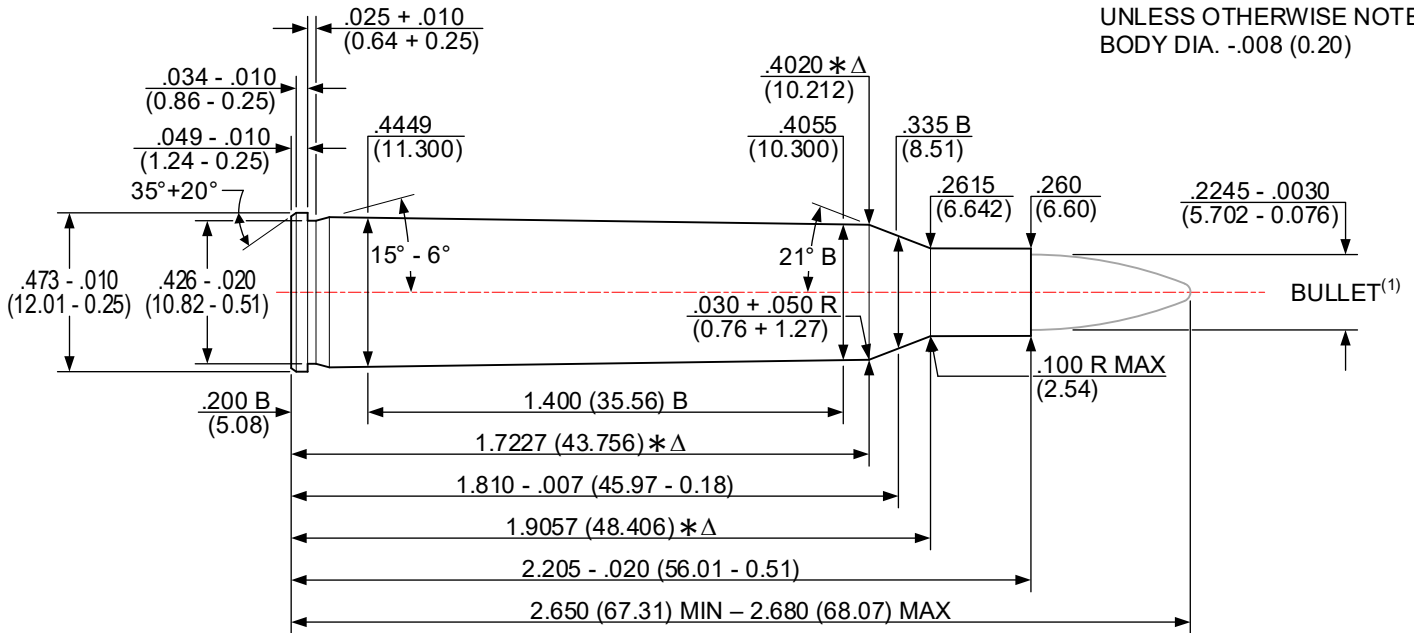

CHAMBER

UNLESS OTHERWISE NOTED
 ALL DIA +.002 (0.05)
 LENGTH TOL. +.015 (0.38)

Δ 6 GROOVES TWIST: 14.00 (355.6) R.H. OPTIONAL
 Δ .074+.002 (1.88+0.05) WIDE MINIMUM BORE & GROOVE AREA: .0388 in² (25.032 mm²)

NOTES:

- B = BASIC (XX.XX) = MILLIMETERS ⊗ = HEADSPACE DIMENSION
- Δ = REFERENCE DIMENSION * = DIMENSIONS ARE TO INTERSECTION OF LINES
- ALL CALCULATIONS APPLY AT MAXIMUM MATERIAL CONDITION (MMC)
- (1) – BULLET PROFILE IS SHOWN FOR ILLUSTRATIVE PURPOSES ONLY

DO NOT SCALE FROM DRAWING

NOTICE: This drawing is subject to change.
 Revisions, if applicable, are available at www.saami.org.

**221 REMINGTON FIREBALL [221 REM FB]
 RIFLE**

ISSUED: 05/29/1979

REVISED: 03/30/2022

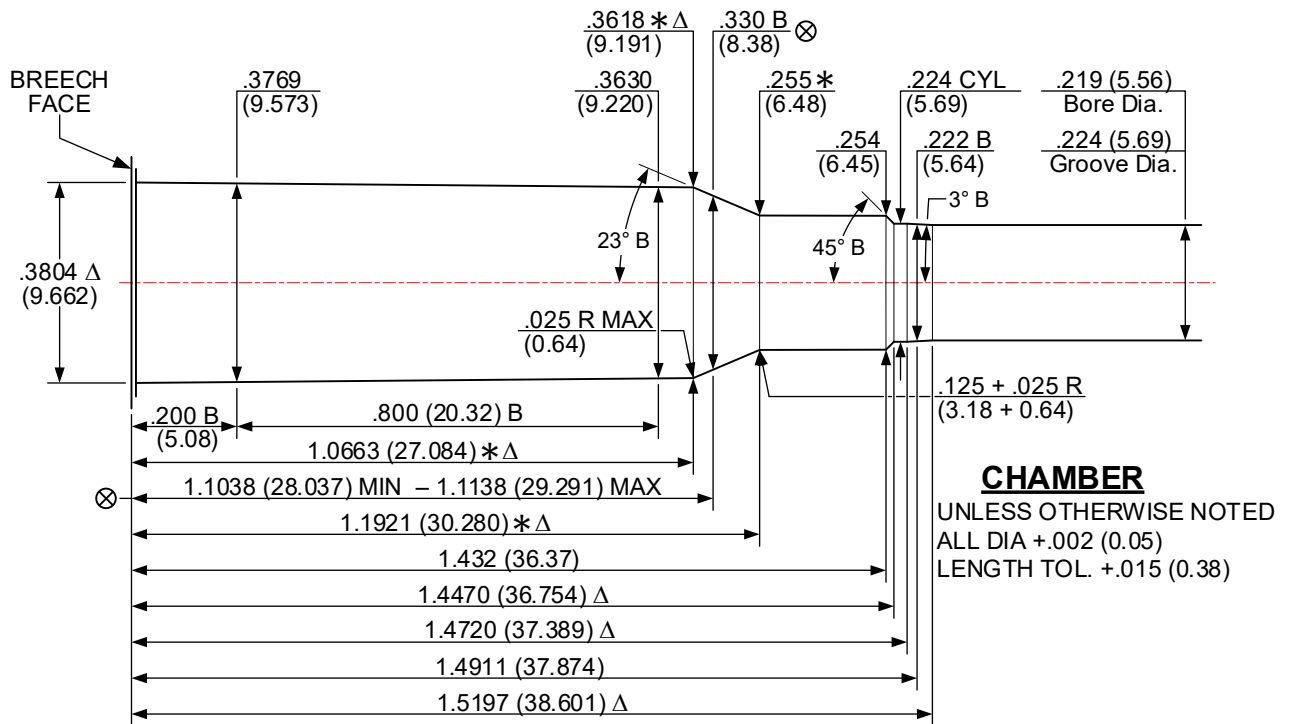
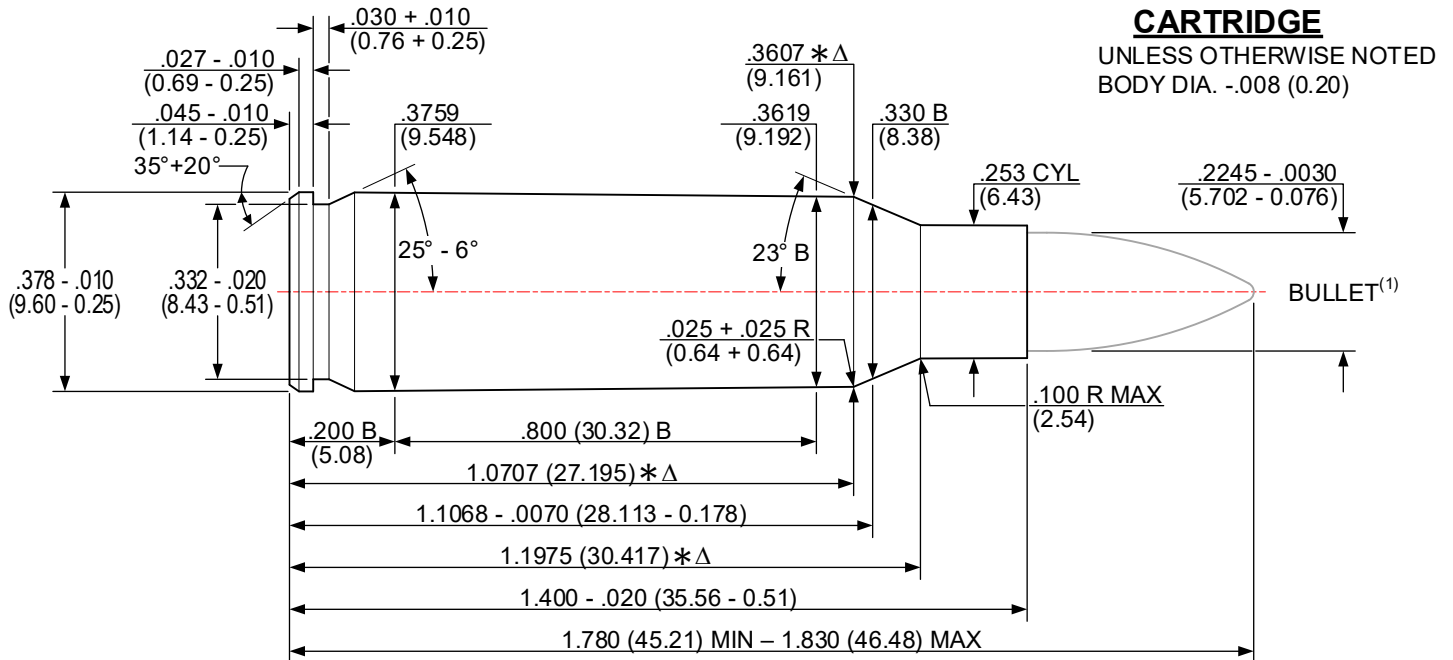

△ 6 GROOVES TWIST: 12.00 (304.8) R.H. OPTIONAL
 △ .080+.002 (2.03+0.05) WIDE MINIMUM BORE & GROOVE AREA: .0388 in² (25.032 mm²)

NOTES:

- B = BASIC
- △ = REFERENCE DIMENSION
- ALL CALCULATIONS APPLY AT MAXIMUM MATERIAL CONDITION (MMC)
- (1) – BULLET PROFILE IS SHOWN FOR ILLUSTRATIVE PURPOSES ONLY
- (XX.XX) = MILLIMETERS
- * = DIMENSIONS ARE TO INTERSECTION OF LINES
- ⊗ = HEADSPACE DIMENSION

DO NOT SCALE FROM DRAWING

ISSUED: 05/29/1979 **222 REMINGTON [222 REM]** REVISED: 03/31/2022

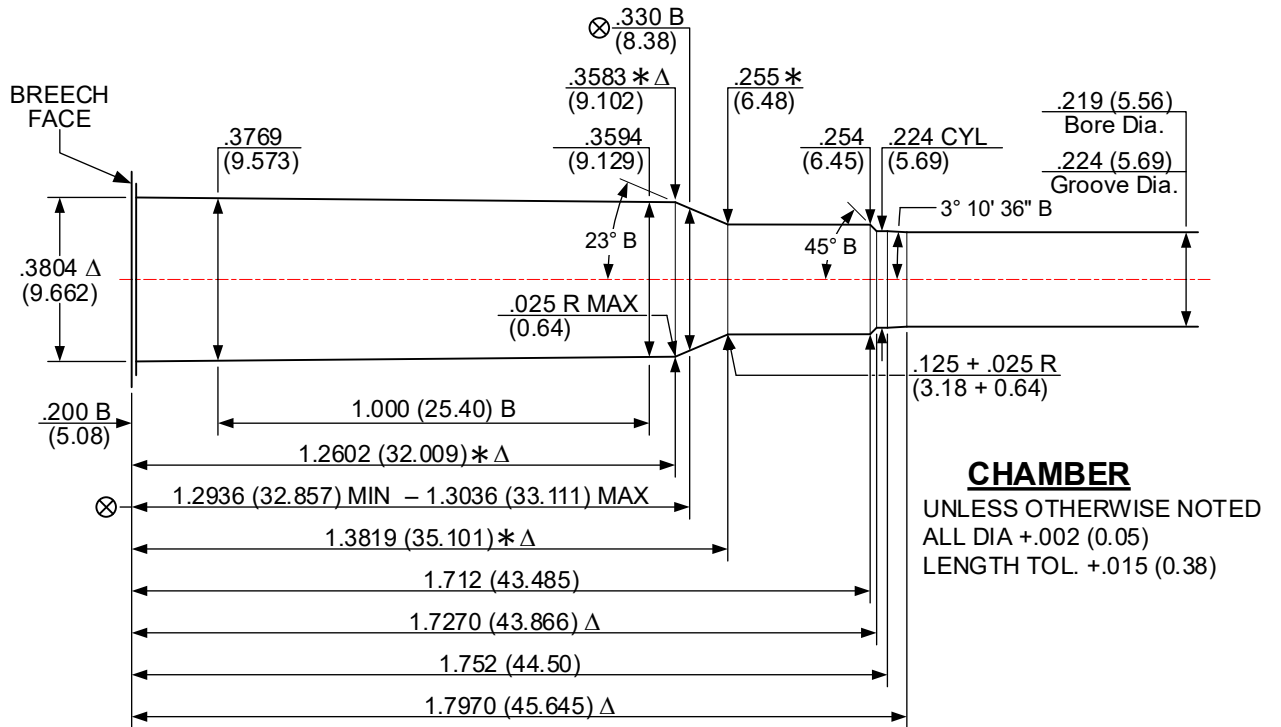
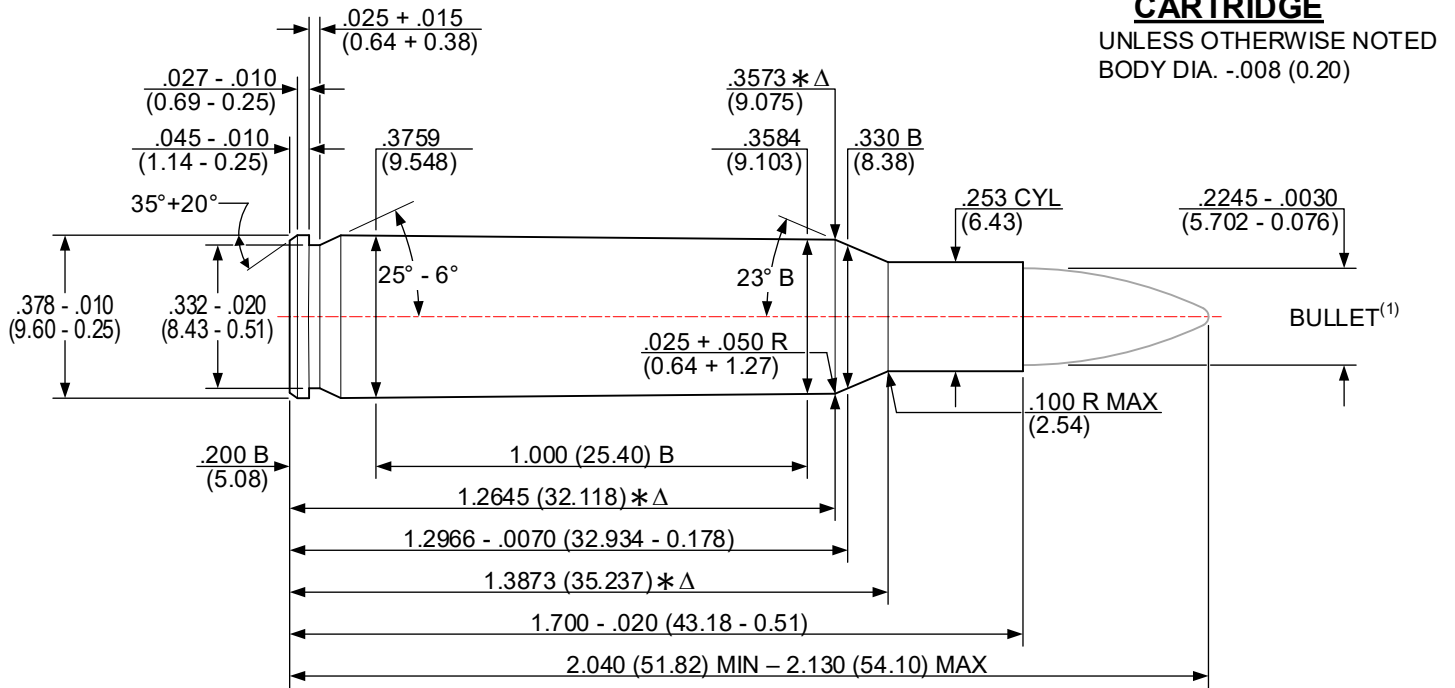

Δ 6 GROOVES TWIST: 14.00 (355.6) R.H. OPTIONAL
 Δ .080+.002 (2.03+0.05) WIDE MINIMUM BORE & GROOVE AREA: .0388 in² (25.032 mm²)

NOTES:
 B = BASIC (XX.XX) = MILLIMETERS \varnothing = HEADSPACE DIMENSION
 Δ = REFERENCE DIMENSION * = DIMENSIONS ARE TO INTERSECTION OF LINES
 ALL CALCULATIONS APPLY AT MAXIMUM MATERIAL CONDITION (MMC)
 (1) – BULLET PROFILE IS SHOWN FOR ILLUSTRATIVE PURPOSES ONLY

DO NOT SCALE FROM DRAWING

NOTICE: This drawing is subject to change.
 Revisions, if applicable, are available at www.saami.org.

ISSUED: 04/21/1980 **222 REMINGTON MAGNUM [222 REM MAG]** REVISED: 04/04/2022

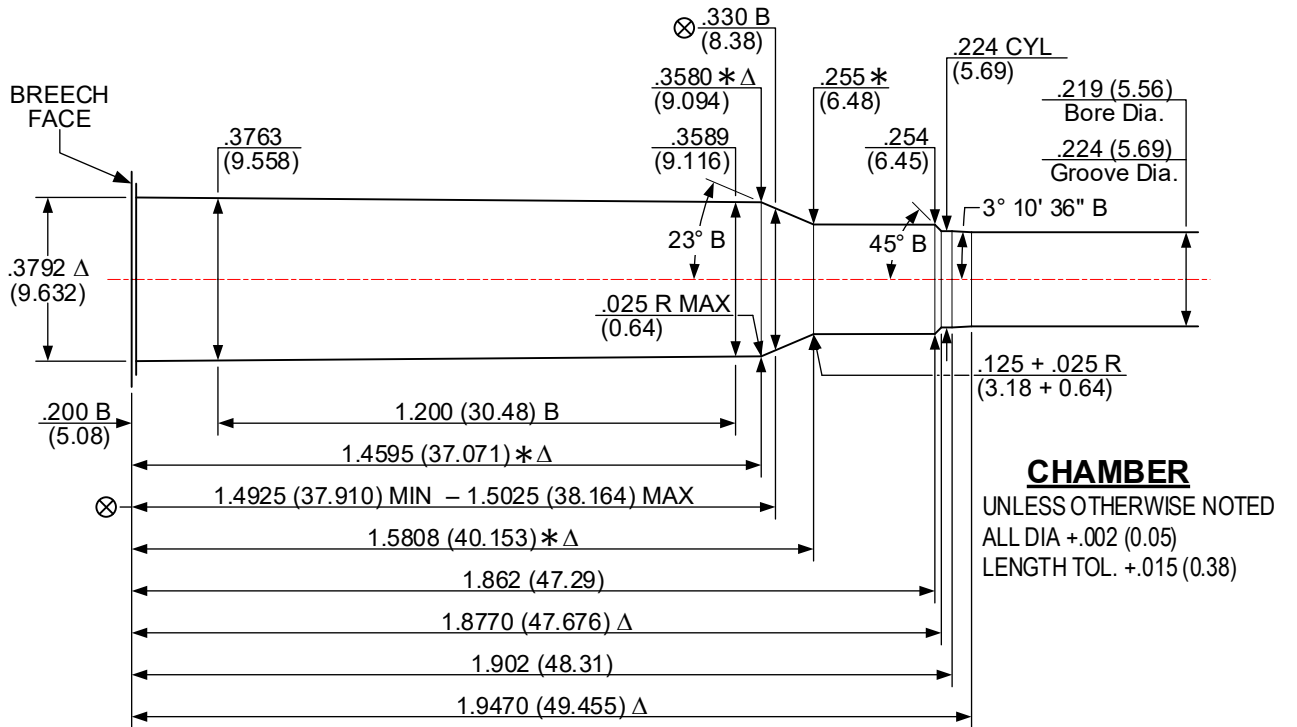
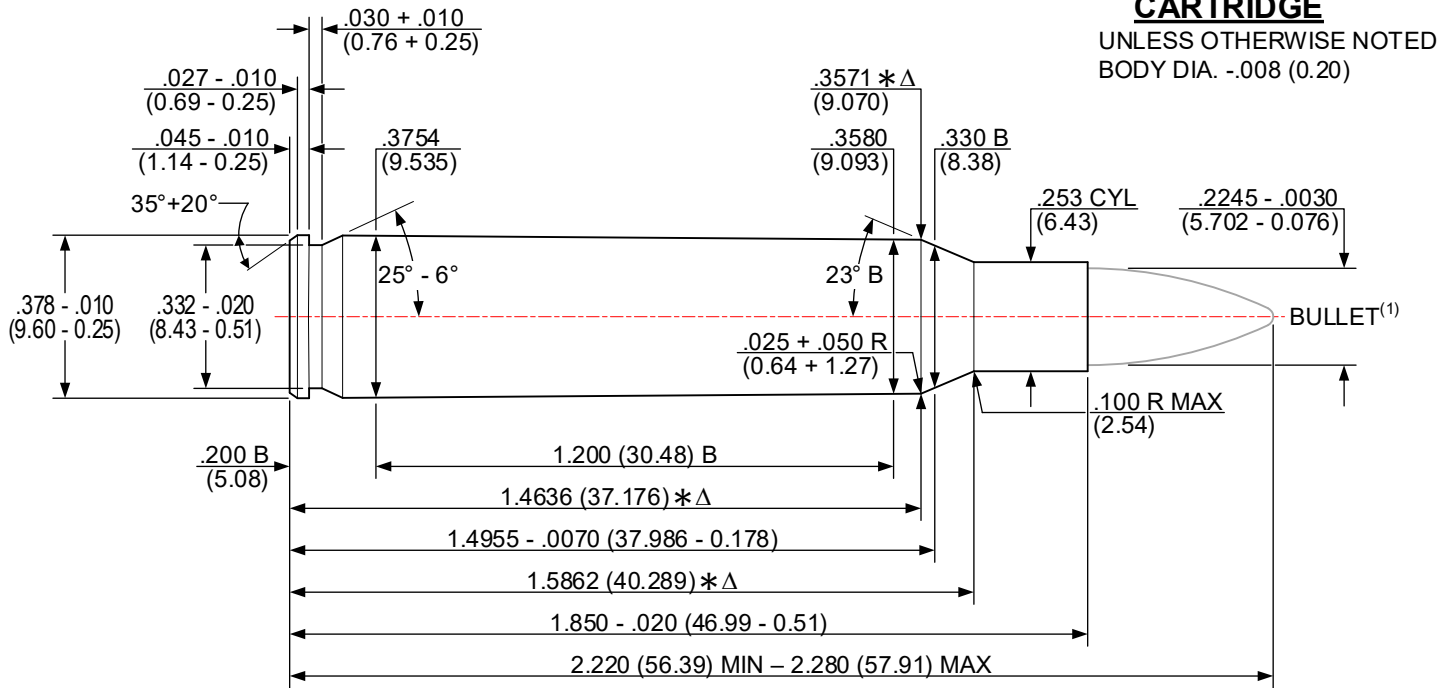

Δ 6 GROOVES TWIST: 14.00 (355.6) R.H. OPTIONAL
 Δ .080+.002 (2.03+0.05) WIDE MINIMUM BORE & GROOVE AREA: .0388 in² (25.032 mm²)

NOTES:

- B = BASIC (XX.XX) = MILLIMETERS ⊗ = HEADSPACE DIMENSION
- Δ = REFERENCE DIMENSION * = DIMENSIONS ARE TO INTERSECTION OF LINES
- ALL CALCULATIONS APPLY AT MAXIMUM MATERIAL CONDITION (MMC)
- (1) – BULLET PROFILE IS SHOWN FOR ILLUSTRATIVE PURPOSES ONLY

DO NOT SCALE FROM DRAWING

NOTICE: This drawing is subject to change.
 Revisions, if applicable, are available at www.saami.org.

ISSUED: 04/21/1980 **223 REMINGTON [223 REM]** REVISED: 09/25/2023

CARTRIDGE

UNLESS OTHERWISE NOTED
 BODY DIA. -.008 (0.20)

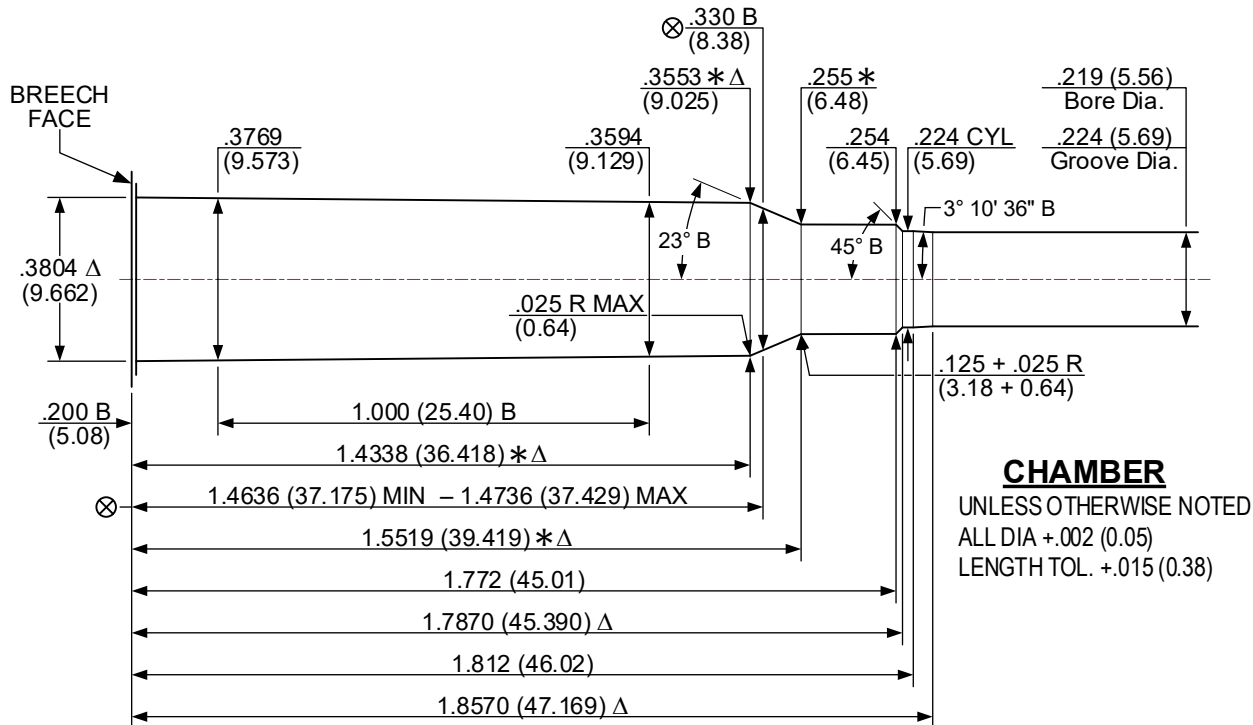
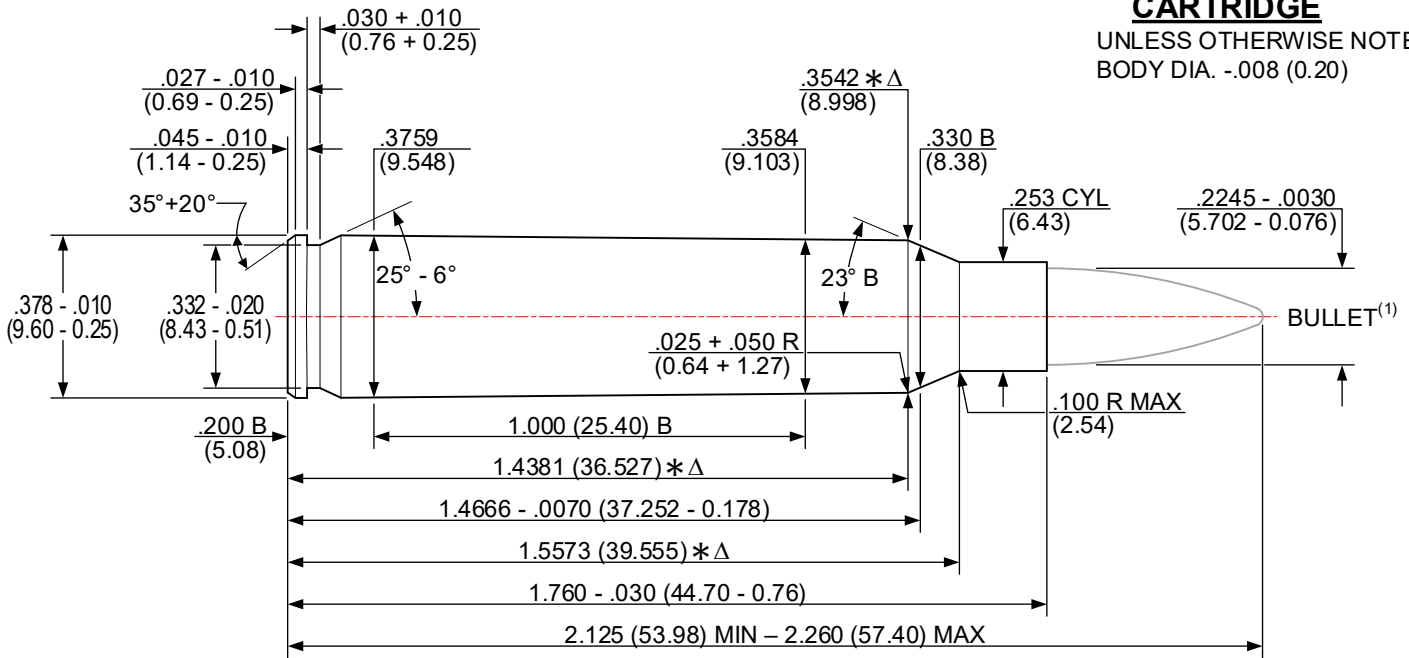

CHAMBER

UNLESS OTHERWISE NOTED
 ALL DIA +.002 (0.05)
 LENGTH TOL. +.015 (0.38)

Δ 6 GROOVES TWIST: 12.00 (304.8) R.H. OPTIONAL
 Δ .074+.002 (1.88+0.05) WIDE MINIMUM BORE & GROOVE AREA: .0388 in² (25.032 mm²)

NOTES:

- B = BASIC (XX.XX) = MILLIMETERS \otimes = HEADSPACE DIMENSION
- Δ = REFERENCE DIMENSION * = DIMENSIONS ARE TO INTERSECTION OF LINES
- ALL CALCULATIONS APPLY AT MAXIMUM MATERIAL CONDITION (MMC)
- (1) - BULLET PROFILE IS SHOWN FOR ILLUSTRATIVE PURPOSES ONLY

DO NOT SCALE FROM DRAWING

NOTICE: This drawing is subject to change.
 Revisions, if applicable, are available at www.saami.org.

ISSUED: 04/21/1980 **223 WINCHESTER SUPER SHORT MAGNUM [223 WSSM]** REVISED: 04/04/2022

CARTRIDGE

UNLESS OTHERWISE NOTED
 BODY DIA. -.008 (0.20)

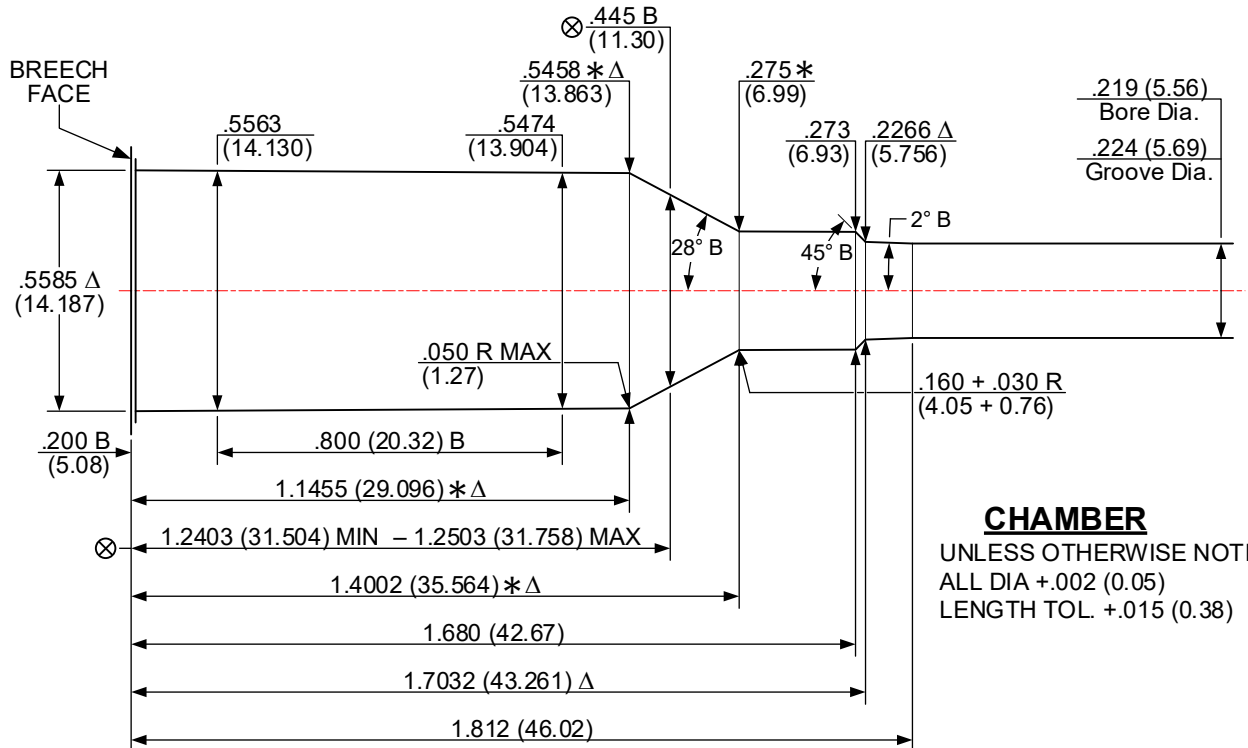
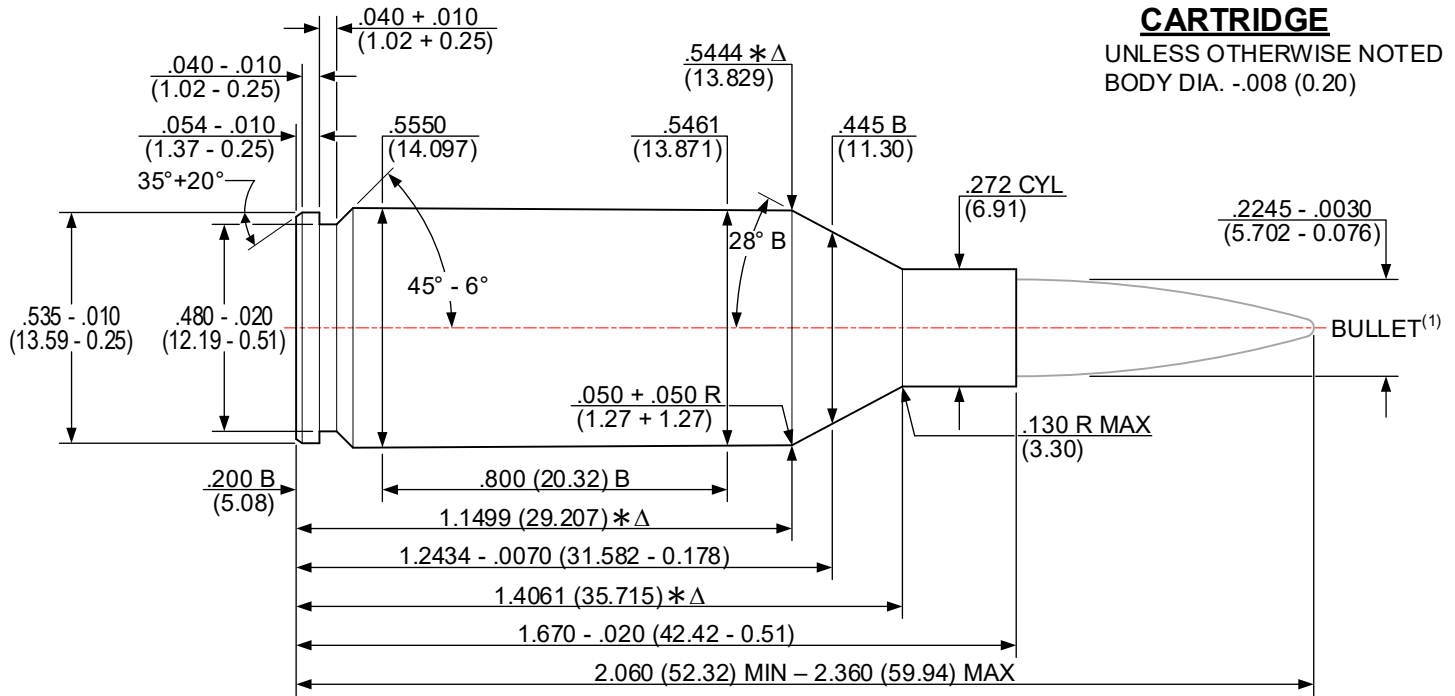

CHAMBER

UNLESS OTHERWISE NOTED
 ALL DIA +.002 (0.05)
 LENGTH TOL. +.015 (0.38)

Δ 6 GROOVES TWIST: 10.00 (254.0) R.H. OPTIONAL
 Δ .080+.002 (2.03+0.05) WIDE MINIMUM BORE & GROOVE AREA: .0388 in² (25.032 mm²)

NOTES:

- B = BASIC
- Δ = REFERENCE DIMENSION
- ALL CALCULATIONS APPLY AT MAXIMUM MATERIAL CONDITION (MMC)
- (1) – BULLET PROFILE IS SHOWN FOR ILLUSTRATIVE PURPOSES ONLY
- (XX.XX) = MILLIMETERS
- * = DIMENSIONS ARE TO INTERSECTION OF LINES
- ⊗ = HEADSPACE DIMENSION

DO NOT SCALE FROM DRAWING

NOTICE: This drawing is subject to change.
 Revisions, if applicable, are available at www.saami.org.

ISSUED: 01/22/2018

224 VALKYRIE [224 VLK]

REVISED: 11/16/2021

CARTRIDGE

UNLESS OTHERWISE NOTED
 BODY DIA. -.008 (0.20)

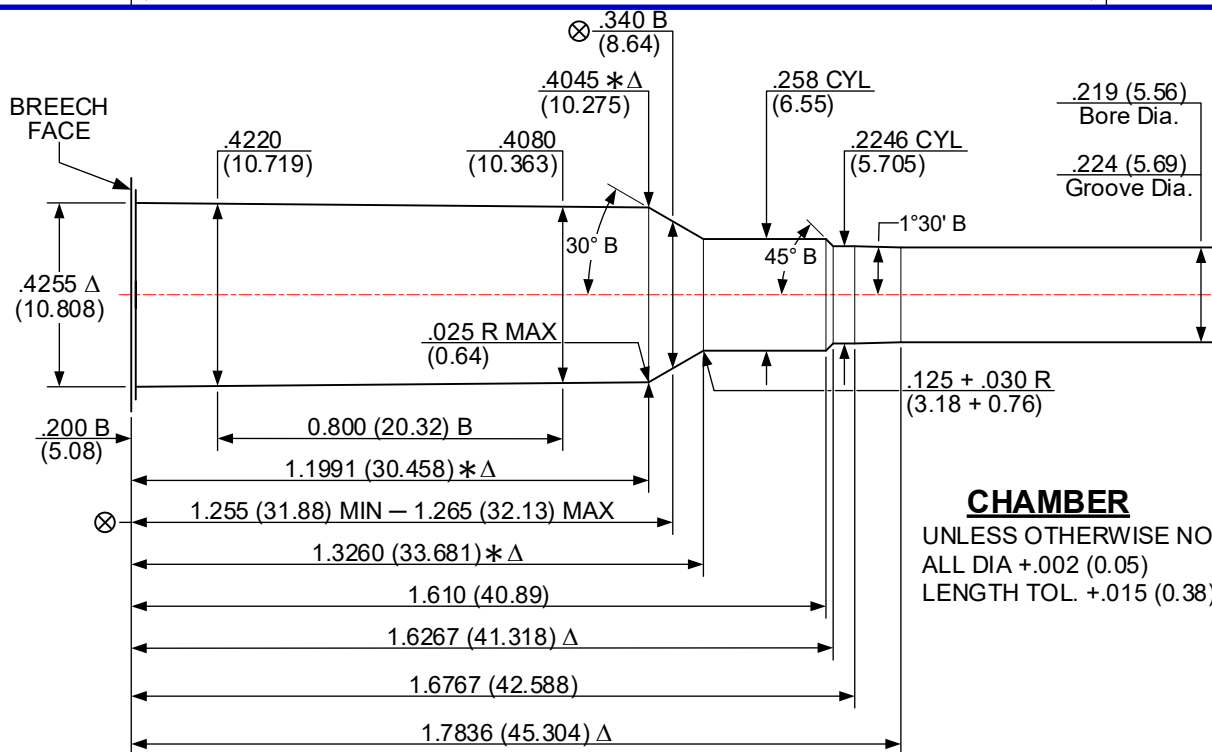
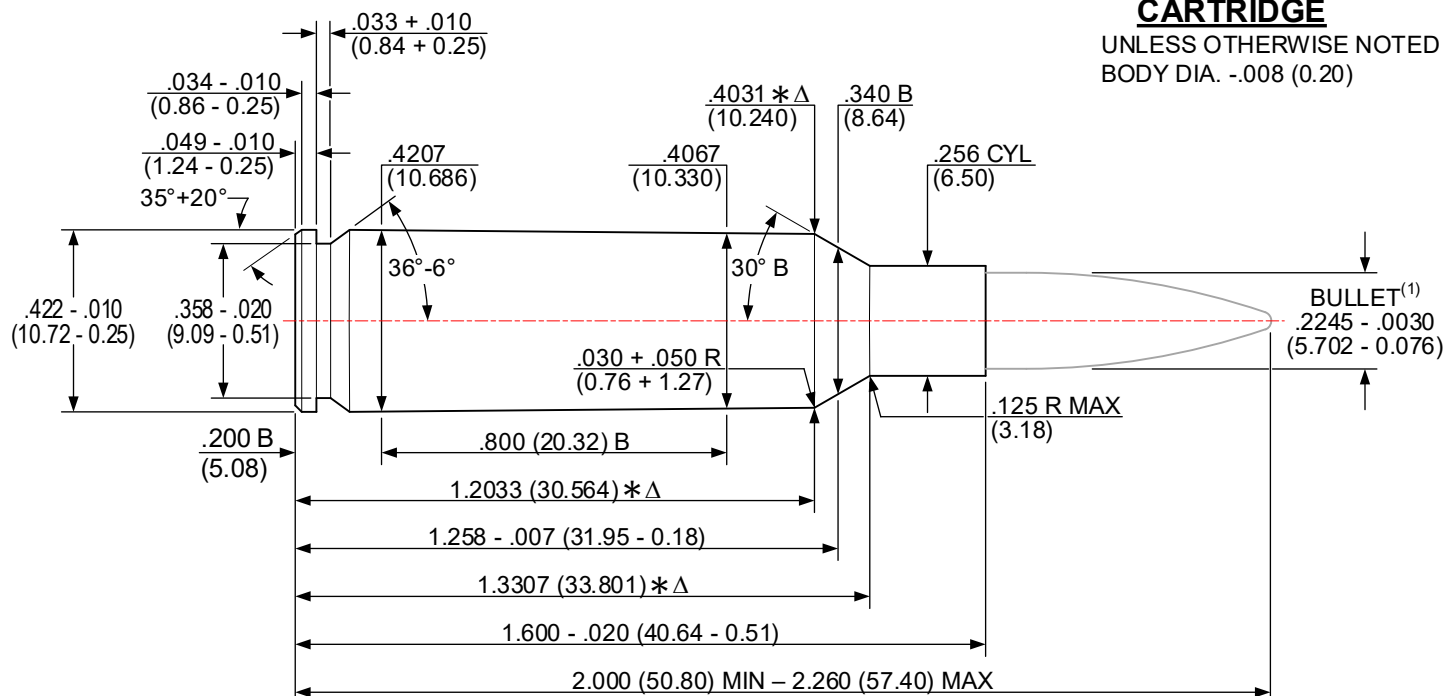

CHAMBER

UNLESS OTHERWISE NOTED
 ALL DIA +.002 (0.05)
 LENGTH TOL. +.015 (0.38)

Δ 6 GROOVES TWIST: 7.00 (177.8) R.H. OPTIONAL
 Δ .074+.002 (1.88+0.05) WIDE MINIMUM BORE & GROOVE AREA: .0388 in² (25.032 mm²)

NOTES:

- B = BASIC
- Δ = REFERENCE DIMENSION
- ALL CALCULATIONS APPLY AT MAXIMUM MATERIAL CONDITION (MMC)
- (1) – BULLET PROFILE IS SHOWN FOR ILLUSTRATIVE PURPOSES ONLY
- (XX.XX) = MILLIMETERS
- * = DIMENSIONS ARE TO INTERSECTION OF LINES
- $\textcircled{\times}$ = HEAD SPACE DIMENSION

DO NOT SCALE FROM DRAWING

NOTICE: This drawing is subject to change.
 Revisions, if applicable, are available at www.saami.org.

ISSUED: 05/29/1979 **243 WINCHESTER [243 WIN]** REVISED: 04/05/2022

CARTRIDGE

UNLESS OTHERWISE NOTED
 BODY DIA. -.008 (0.20)

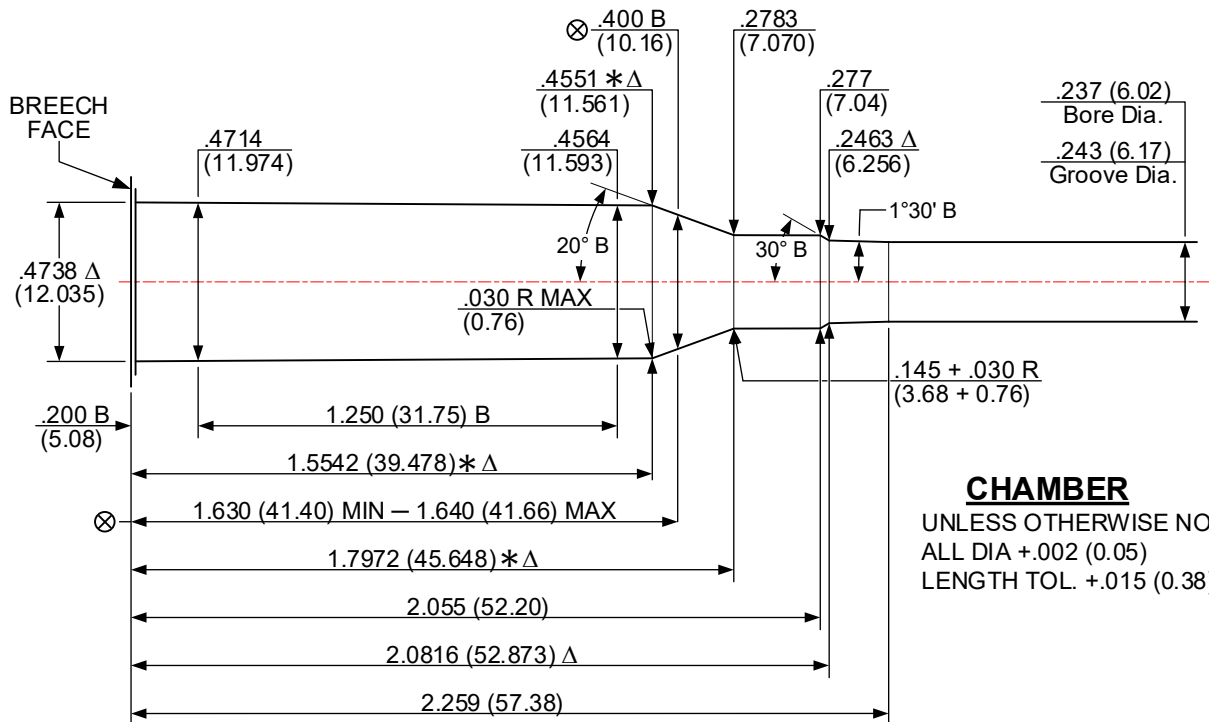
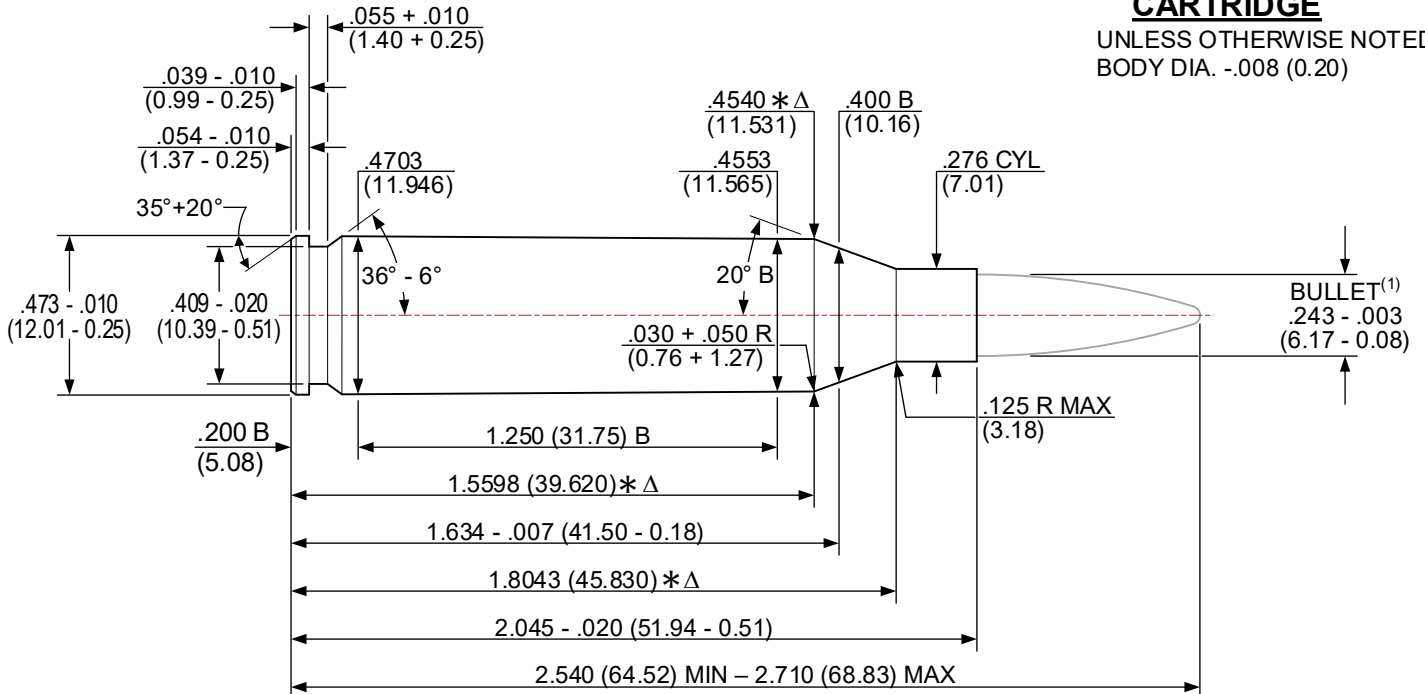

CHAMBER

UNLESS OTHERWISE NOTED
 ALL DIA +.002 (0.05)
 LENGTH TOL. +.015 (0.38)

Δ 6 GROOVES TWIST: 10.00 (254.0) R.H. OPTIONAL
 Δ .068+.002 (1.73+0.05) WIDE MINIMUM BORE & GROOVE AREA: .0453 in² (29.225 mm²)

NOTES:

- B = BASIC
- Δ = REFERENCE DIMENSION
- ALL CALCULATIONS APPLY AT MAXIMUM MATERIAL CONDITION (MMC)
- (1) – BULLET PROFILE IS SHOWN FOR ILLUSTRATIVE PURPOSES ONLY
- (XX.XX) = MILLIMETERS
- * = DIMENSIONS ARE TO INTERSECTION OF LINES
- ⊗ = HEAD SPACE DIMENSION

DO NOT SCALE FROM DRAWING

ISSUED: 02/11/2004 **243 WINCHESTER SUPER SHORT MAGNUM [243 WSSM]** REVISED: 04/06/2022

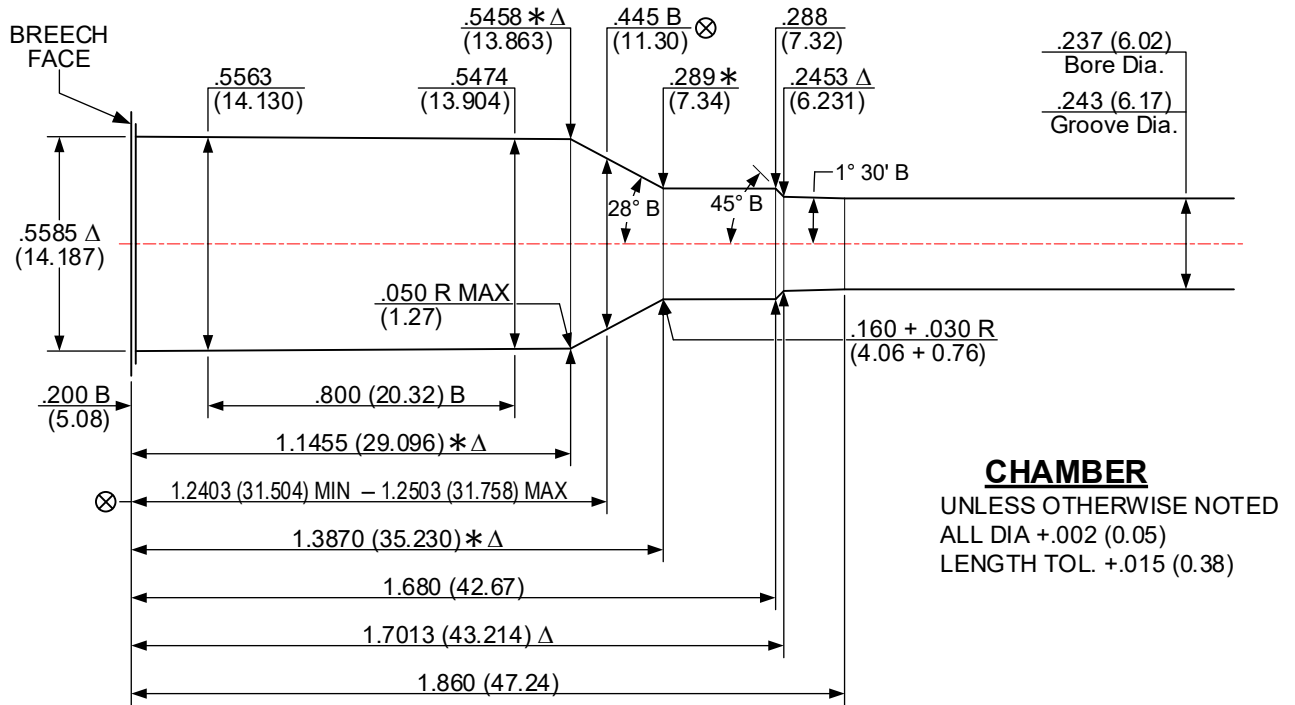
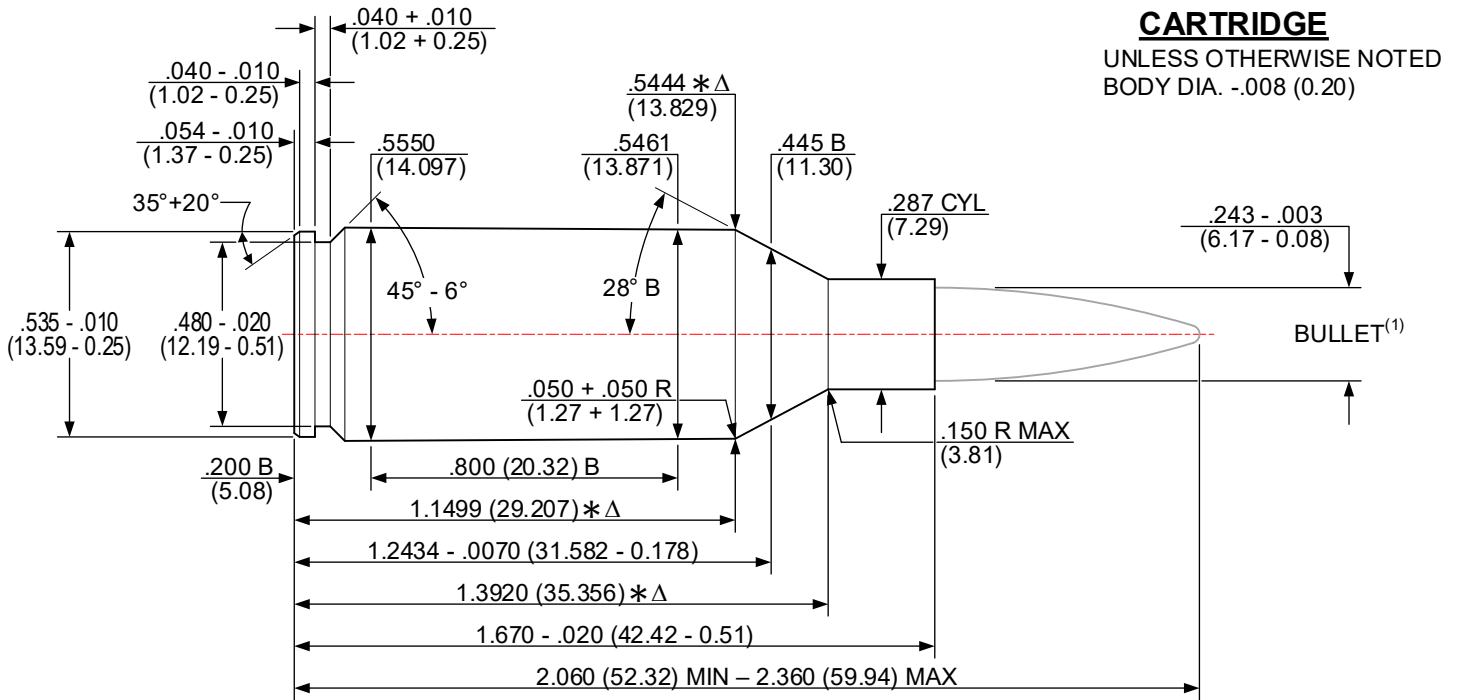

Δ 4 GROOVES TWIST: 10.00 (254.0) R.H. OPTIONAL
 Δ .100+.002 (2.54+0.05) WIDE MINIMUM BORE & GROOVE AREA: .0453 in² (29.225 mm²)

NOTES:

- B = BASIC (XX.XX) = MILLIMETERS ⊗ = HEADSPACE DIMENSION
- Δ = REFERENCE DIMENSION * = DIMENSIONS ARE TO INTERSECTION OF LINES
- ALL CALCULATIONS APPLY AT MAXIMUM MATERIAL CONDITION (MMC)
- (1) – BULLET PROFILE IS SHOWN FOR ILLUSTRATIVE PURPOSES ONLY

DO NOT SCALE FROM DRAWING

NOTICE: This drawing is subject to change.
 Revisions, if applicable, are available at www.saami.org.

ISSUED: 06/23/2004 **25 WINCHESTER SUPER SHORT MAGNUM [25 WSSM]** **REVISED: 04/06/2022**

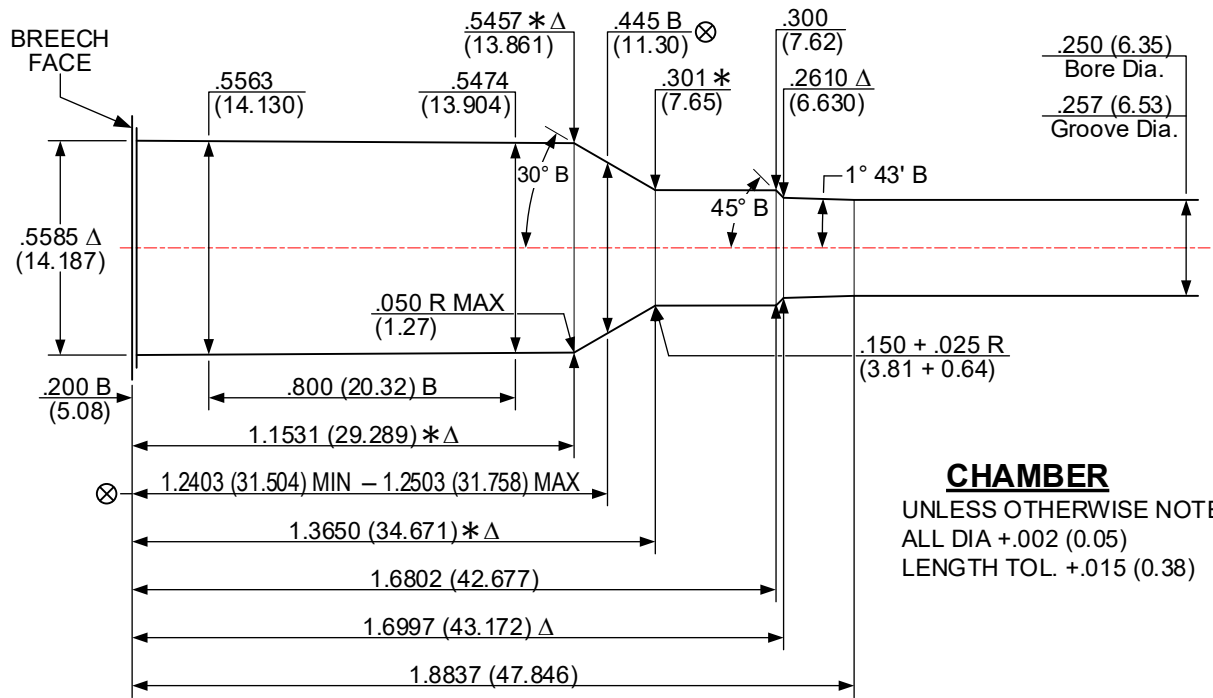
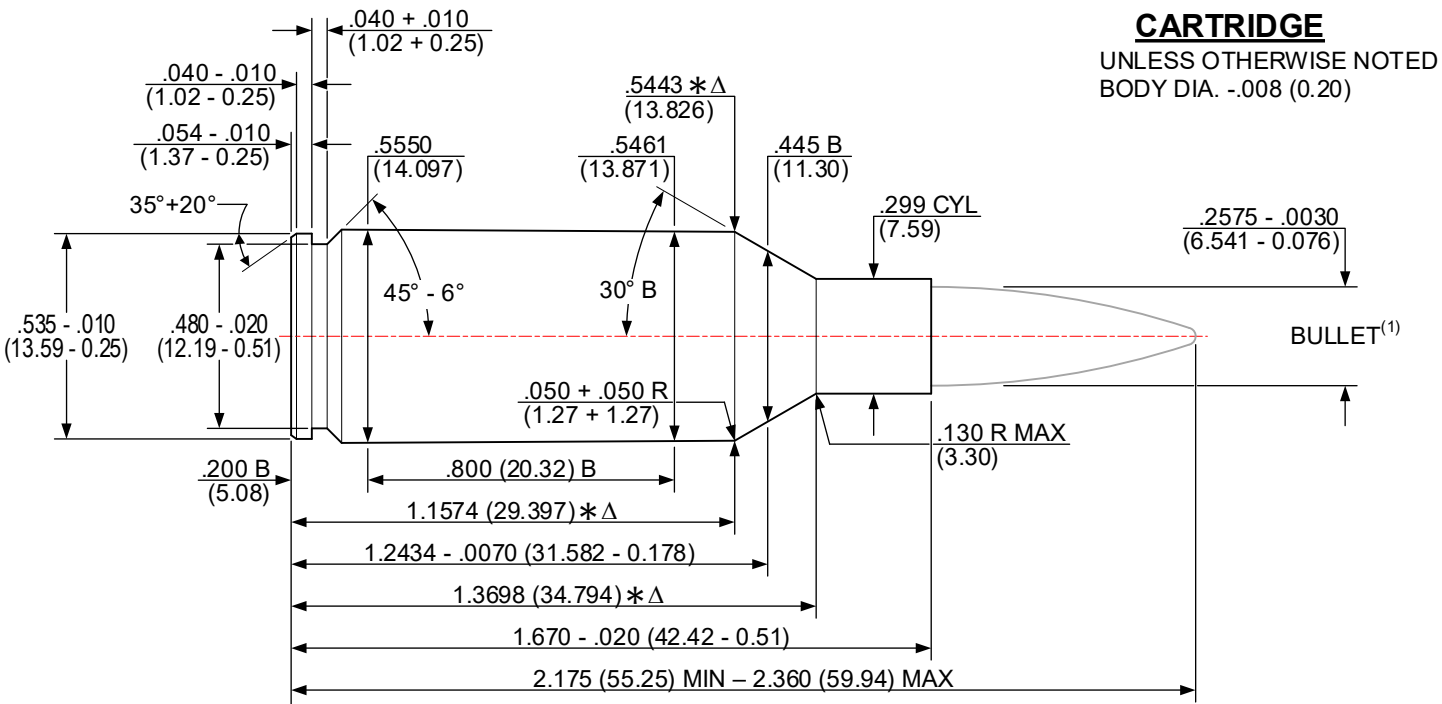

Δ 4 GROOVES TWIST: 10.00 (254.0) R.H. OPTIONAL
 Δ .096+.002 (2.44+0.05) WIDE MINIMUM BORE & GROOVE AREA: .0511 in² (32.968 mm²)

NOTES:
 B = BASIC (XX.XX) = MILLIMETERS ⊗ = HEADSPACE DIMENSION
 Δ = REFERENCE DIMENSION * = DIMENSIONS ARE TO INTERSECTION OF LINES
 ALL CALCULATIONS APPLY AT MAXIMUM MATERIAL CONDITION (MMC)
 (1) – BULLET PROFILE IS SHOWN FOR ILLUSTRATIVE PURPOSES ONLY

DO NOT SCALE FROM DRAWING

NOTICE: This drawing is subject to change.
 Revisions, if applicable, are available at www.saami.org.

ISSUED: 05/29/1979

25-06 REMINGTON [25-06 REM]

REVISED: 04/06/2022

CARTRIDGE

UNLESS OTHERWISE NOTED
 BODY DIA. -.008 (0.20)

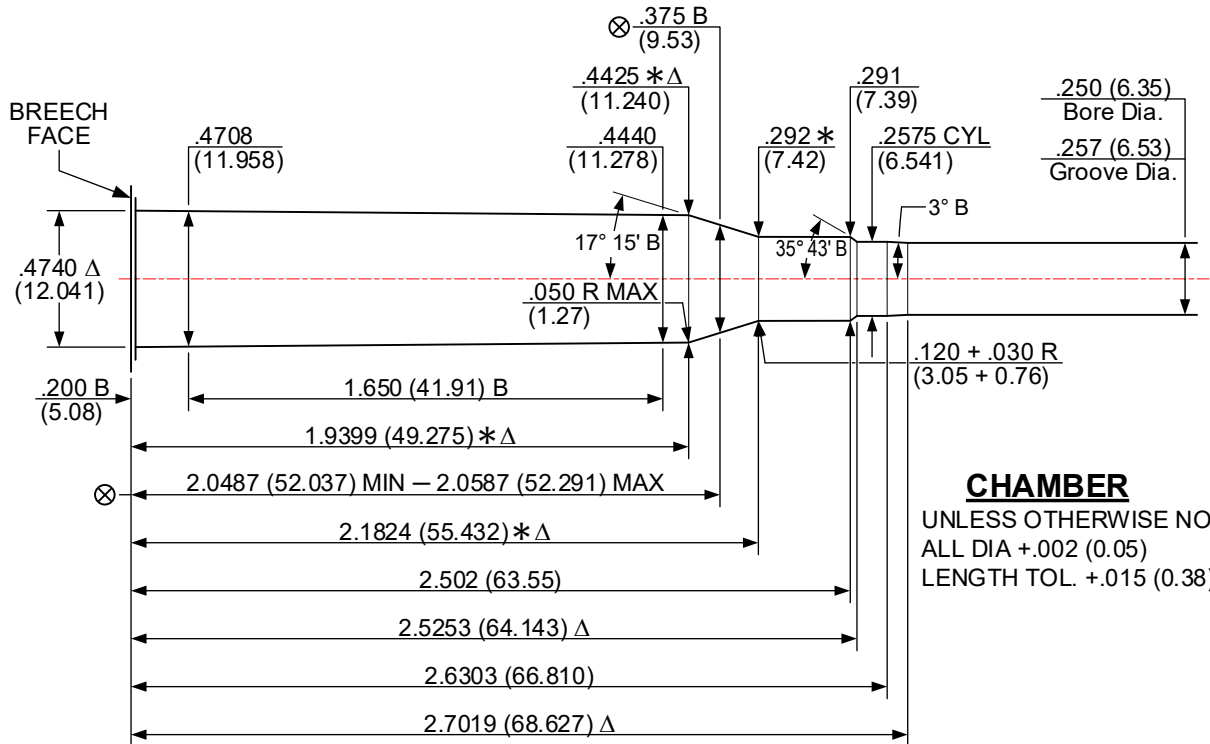
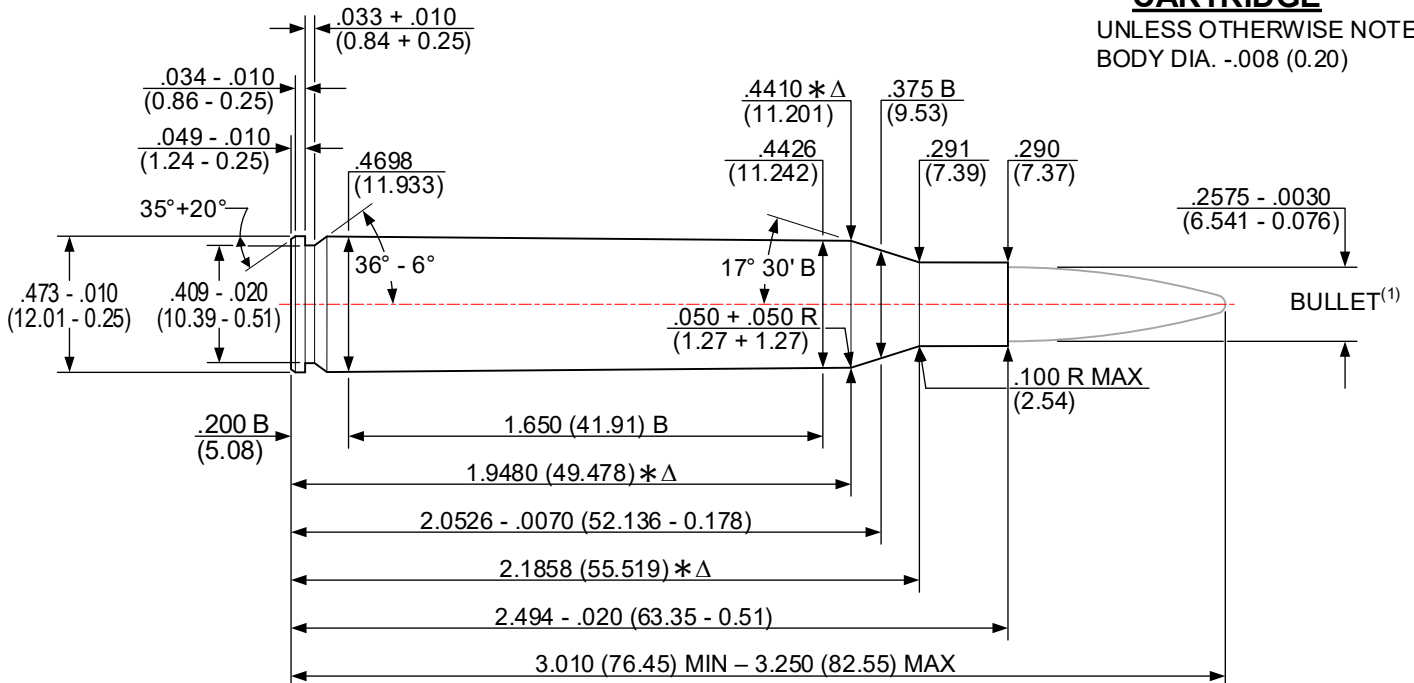

CHAMBER

UNLESS OTHERWISE NOTED
 ALL DIA +.002 (0.05)
 LENGTH TOL. +.015 (0.38)

Δ 6 GROOVES TWIST: 10.00 (254.0) R.H. OPTIONAL
 Δ .096+.002 (2.44+0.05) WIDE MINIMUM BORE & GROOVE AREA: .0511 in² (32.967 mm²)

NOTES:

- B = BASIC
- Δ = REFERENCE DIMENSION
- ALL CALCULATIONS APPLY AT MAXIMUM MATERIAL CONDITION (MMC)
- (1) – BULLET PROFILE IS SHOWN FOR ILLUSTRATIVE PURPOSES ONLY
- (XX.XX) = MILLIMETERS
- * = DIMENSIONS ARE TO INTERSECTION OF LINES
- ⊗ = HEAD SPACE DIMENSION

DO NOT SCALE FROM DRAWING

NOTICE: This drawing is subject to change.
 Revisions, if applicable, are available at www.saami.org.

ISSUED: 04/21/1980

25-20 WINCHESTER [25-20 WIN]

REVISED: 02/10/2023

CARTRIDGE

UNLESS OTHERWISE NOTED
 BODY DIA. -.008 (0.20)

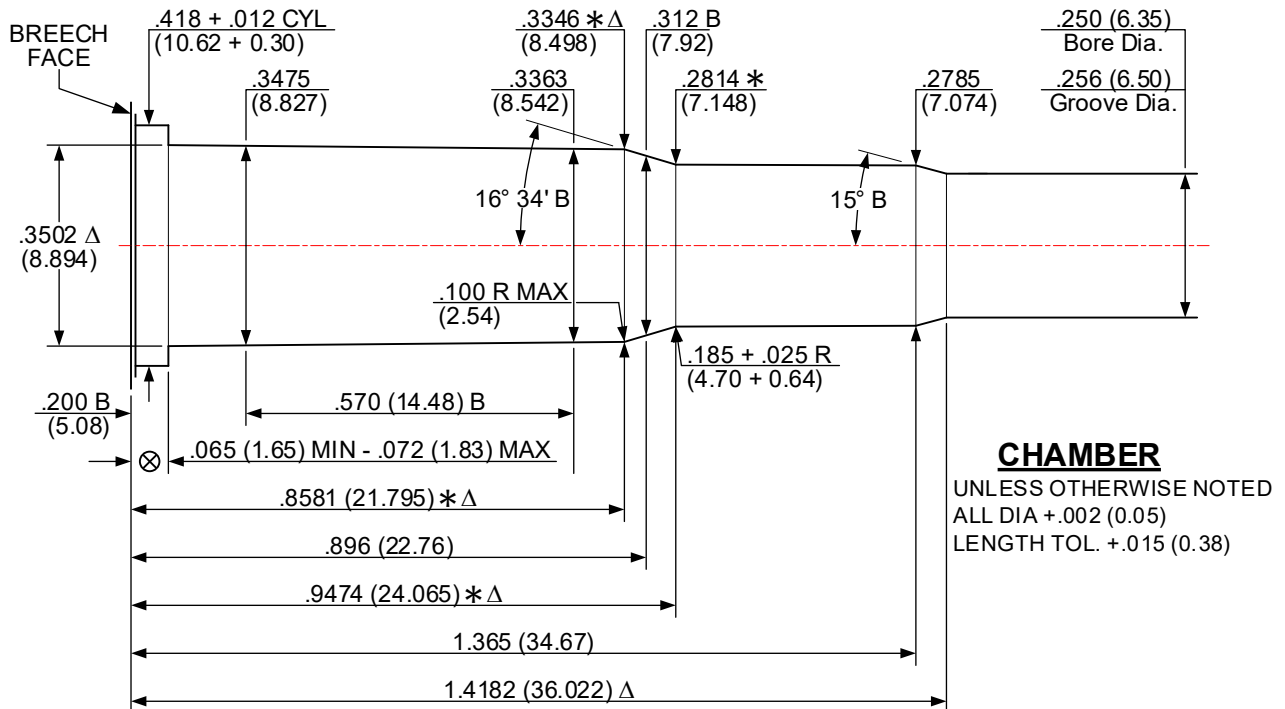
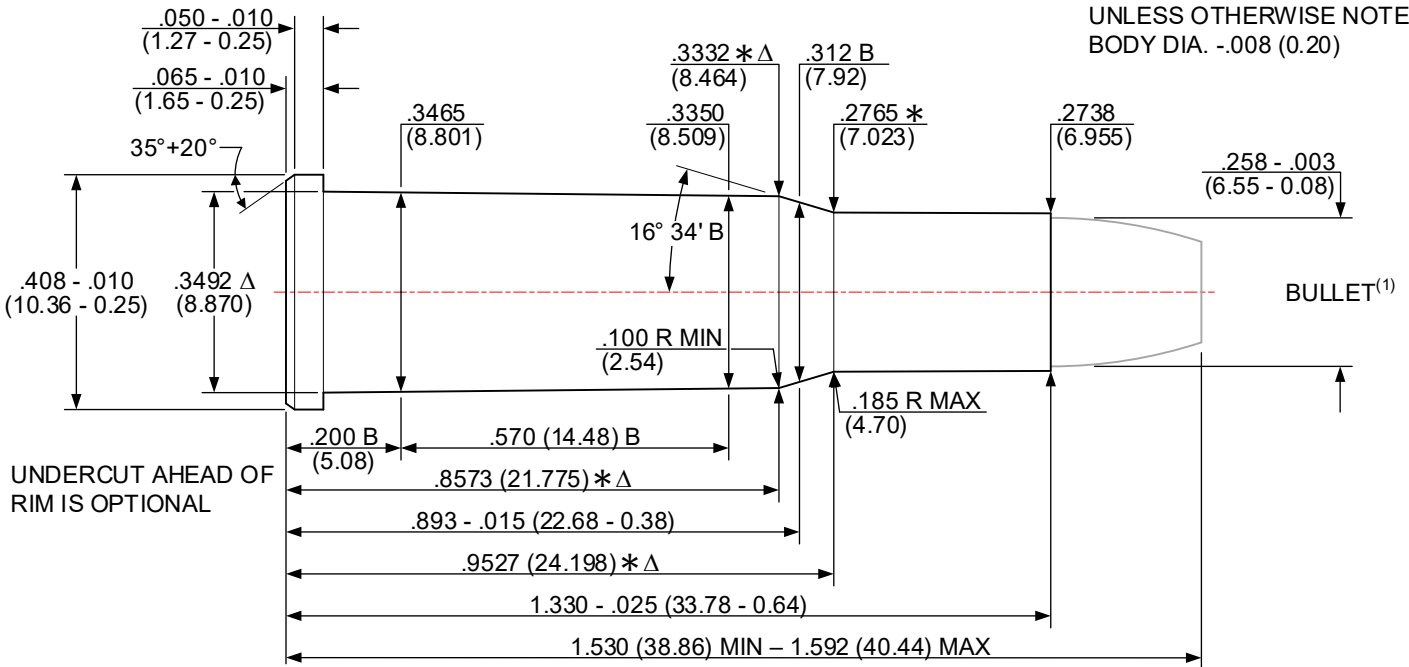

CHAMBER

UNLESS OTHERWISE NOTED
 ALL DIA +.002 (0.05)
 LENGTH TOL. +.015 (0.38)

Δ 6 GROOVES TWIST: 14.00 (355.6) R.H. OPTIONAL
 Δ .078+.002 (1.98+0.05) WIDE MINIMUM BORE & GROOVE AREA: .0505 in² (32.580 mm²)

NOTES:

- B = BASIC
- Δ = REFERENCE DIMENSION
- ALL CALCULATIONS APPLY AT MAXIMUM MATERIAL CONDITION (MMC)
- (1) – BULLET PROFILE IS SHOWN FOR ILLUSTRATIVE PURPOSES ONLY
- (XX.XX) = MILLIMETERS
- * = DIMENSIONS ARE TO INTERSECTION OF LINES
- ⊗ = HEAD SPACE DIMENSION

DO NOT SCALE FROM DRAWING

NOTICE: This drawing is subject to change.
 Revisions, if applicable, are available at www.saami.org.

ISSUED: 01/18/1991 **25-35 WINCHESTER [25-35 WIN]** REVISED: 02/10/2023

CARTRIDGE

UNLESS OTHERWISE NOTED
 BODY DIA. -.008 (0.20)

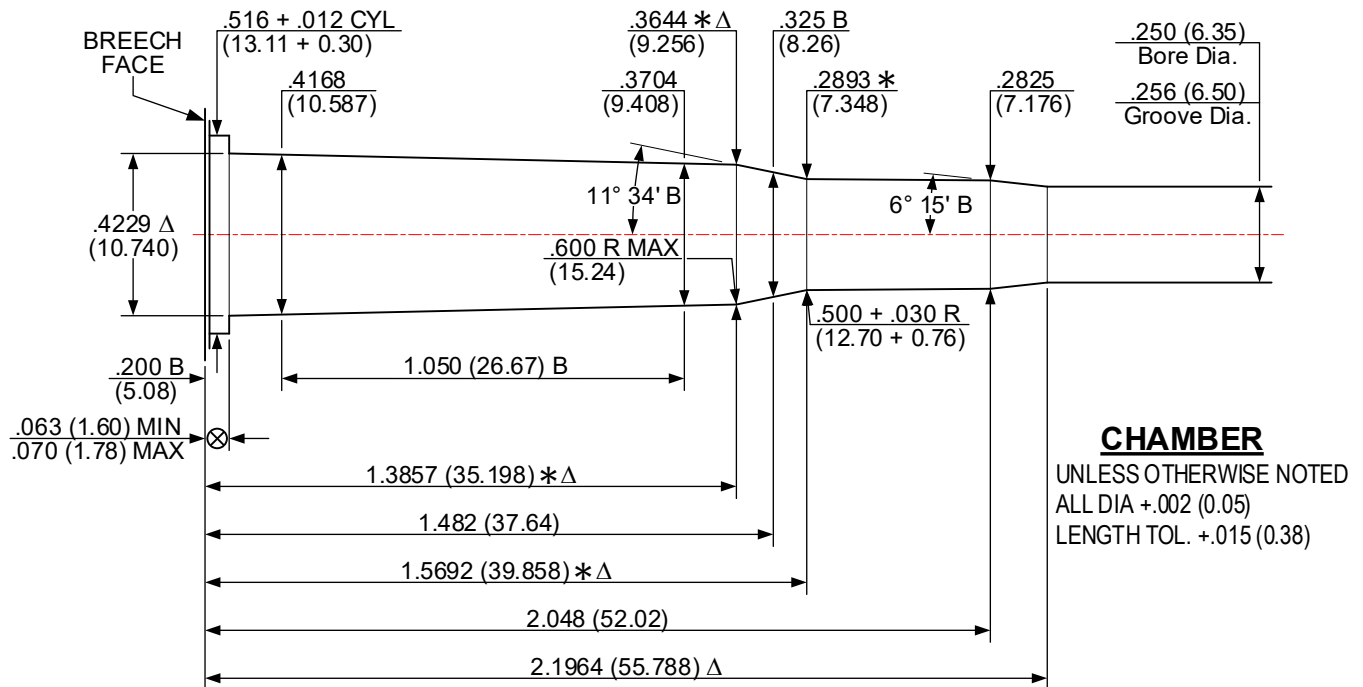
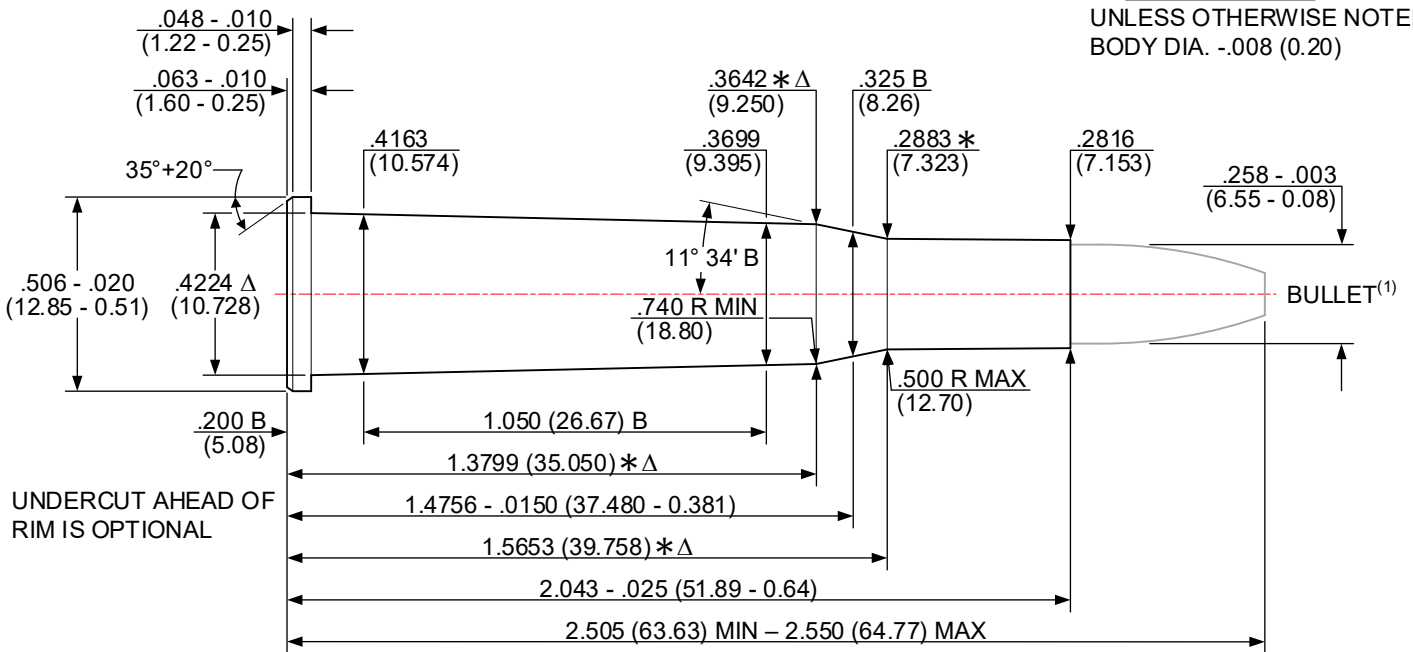

Δ 6 GROOVES TWIST: 8.00 (203.2) R.H. OPTIONAL
 Δ .0786+.0020 (1.996+0.051) WIDE MINIMUM BORE & GROOVE AREA: .0505 in² (32.580 mm²)

NOTES:

- B = BASIC (XX.XX) = MILLIMETERS ⊗ = HEAD SPACE DIMENSION
- Δ = REFERENCE DIMENSION * = DIMENSIONS ARE TO INTERSECTION OF LINES
- ALL CALCULATIONS APPLY AT MAXIMUM MATERIAL CONDITION (MMC)
- (1) – BULLET PROFILE IS SHOWN FOR ILLUSTRATIVE PURPOSES ONLY

DO NOT SCALE FROM DRAWING

NOTICE: This drawing is subject to change.
 Revisions, if applicable, are available at www.saami.org.

ISSUED: 05/29/1979 **250 SAVAGE [250 SAV]** REVISED: 05/02/2022

CARTRIDGE

UNLESS OTHERWISE NOTED
 BODY DIA. -.008 (0.20)

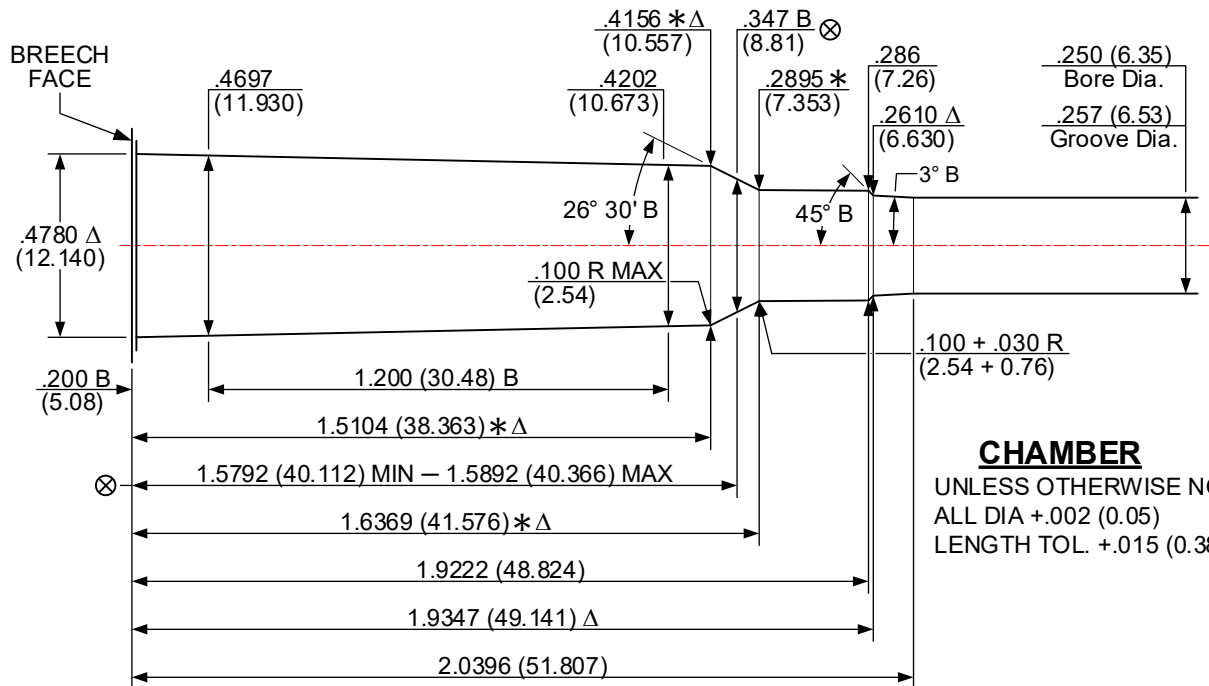
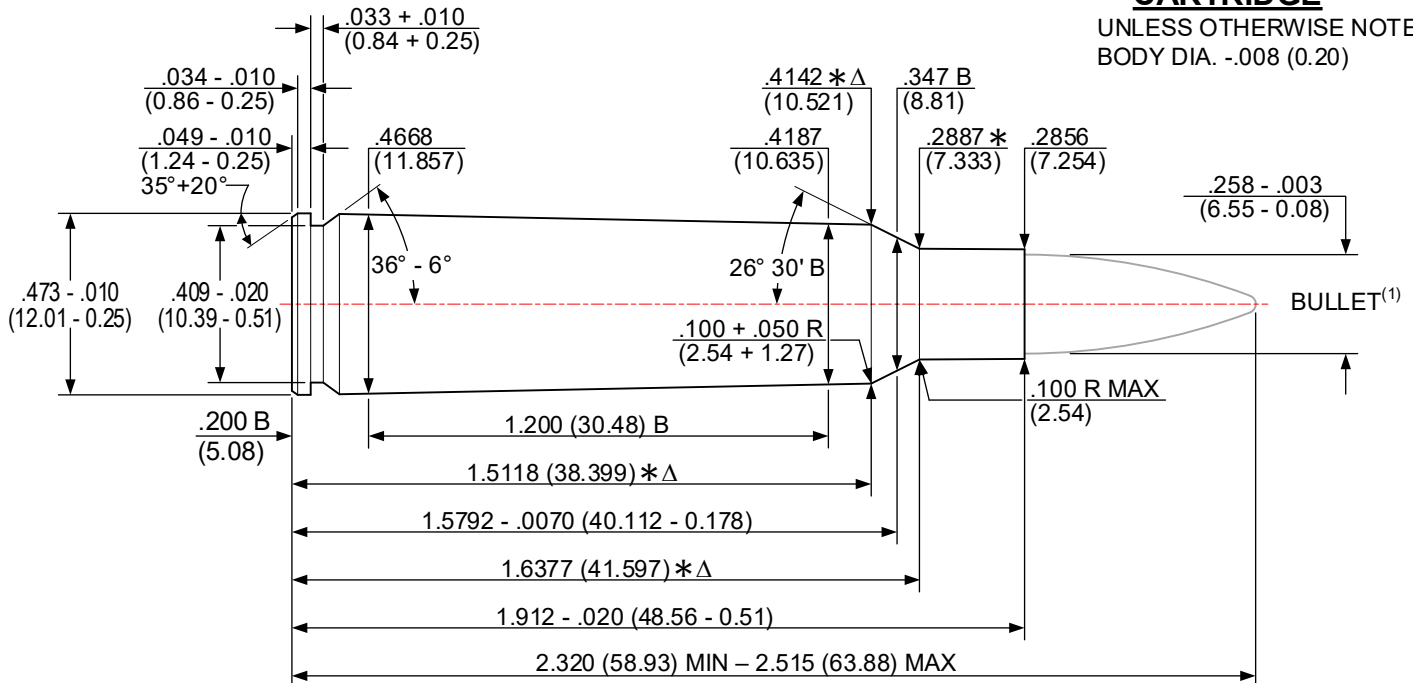

CHAMBER

UNLESS OTHERWISE NOTED
 ALL DIA +.002 (0.05)
 LENGTH TOL. +.015 (0.38)

△ 6 GROOVES TWIST: 14.00 (355.6) R.H. OPTIONAL
 △ .088+.002 (2.24+0.05) WIDE MINIMUM BORE & GROOVE AREA: .0509 in² (32.838 mm²)

NOTES:

- B = BASIC (XX.XX) = MILLIMETERS ⊗ = HEAD SPACE DIMENSION
- △ = REFERENCE DIMENSION * = DIMENSIONS ARE TO INTERSECTION OF LINES
- ALL CALCULATIONS APPLY AT MAXIMUM MATERIAL CONDITION (MMC)
- (1) – BULLET PROFILE IS SHOWN FOR ILLUSTRATIVE PURPOSES ONLY

DO NOT SCALE FROM DRAWING

NOTICE: This drawing is subject to change.
 Revisions, if applicable, are available at www.saami.org.

ISSUED: 05/29/1979 **257 ROBERTS [257 ROB] / 257 ROBERTS +P [257 ROB +P]** REVISED: 05/02/20

CARTRIDGE

UNLESS OTHERWISE NOTED
 BODY DIA. -.008 (0.20)

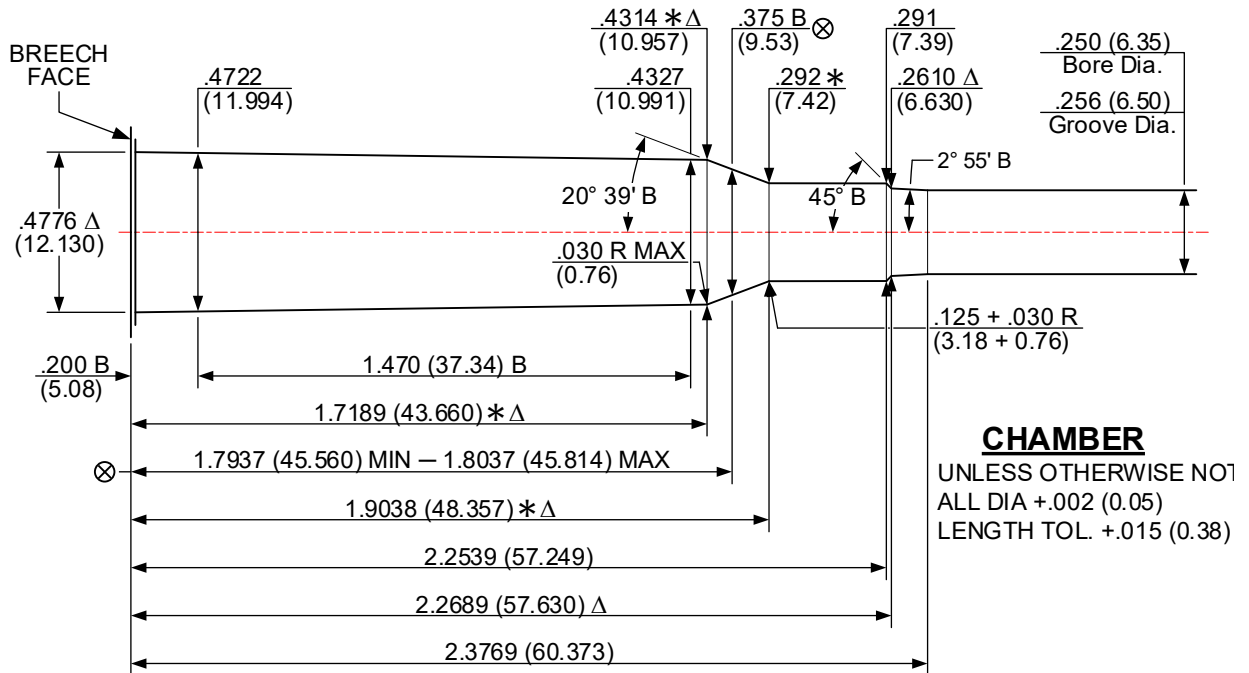
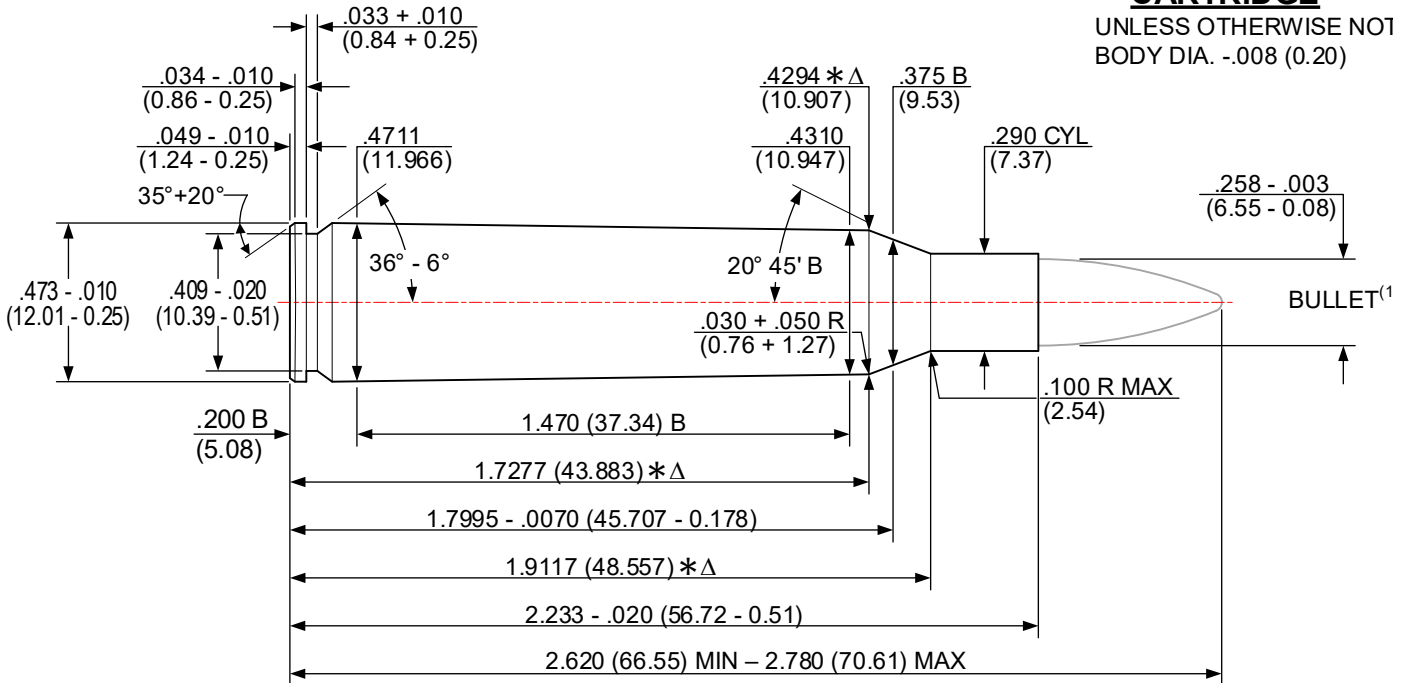

CHAMBER

UNLESS OTHERWISE NOTED
 ALL DIA +.002 (0.05)
 LENGTH TOL. +.015 (0.38)

Δ 6 GROOVES TWIST: 10.00 (254.0) R.H. OPTIONAL
 Δ .095+.002 (2.41+0.05) WIDE MINIMUM BORE & GROOVE AREA: .0508 in² (32.774 mm²)

NOTES:

- B = BASIC
- Δ = REFERENCE DIMENSION
- ALL CALCULATIONS APPLY AT MAXIMUM MATERIAL CONDITION (MMC)
- (1) – BULLET PROFILE IS SHOWN FOR ILLUSTRATIVE PURPOSES ONLY
- (XX.XX) = MILLIMETERS
- * = DIMENSIONS ARE TO INTERSECTION OF LINES
- ⊗ = HEAD SPACE DIMENSION

DO NOT SCALE FROM DRAWING

NOTICE: This drawing is subject to change.
 Revisions, if applicable, are available at www.saami.org.

ISSUED: 06/04/1991

257 WEATHERBY MAGNUM [257 WBY MAG]

REVISED: 01/21/2024

CARTRIDGE

UNLESS OTHERWISE NOTED
 BODY DIA. -.004 (0.10)

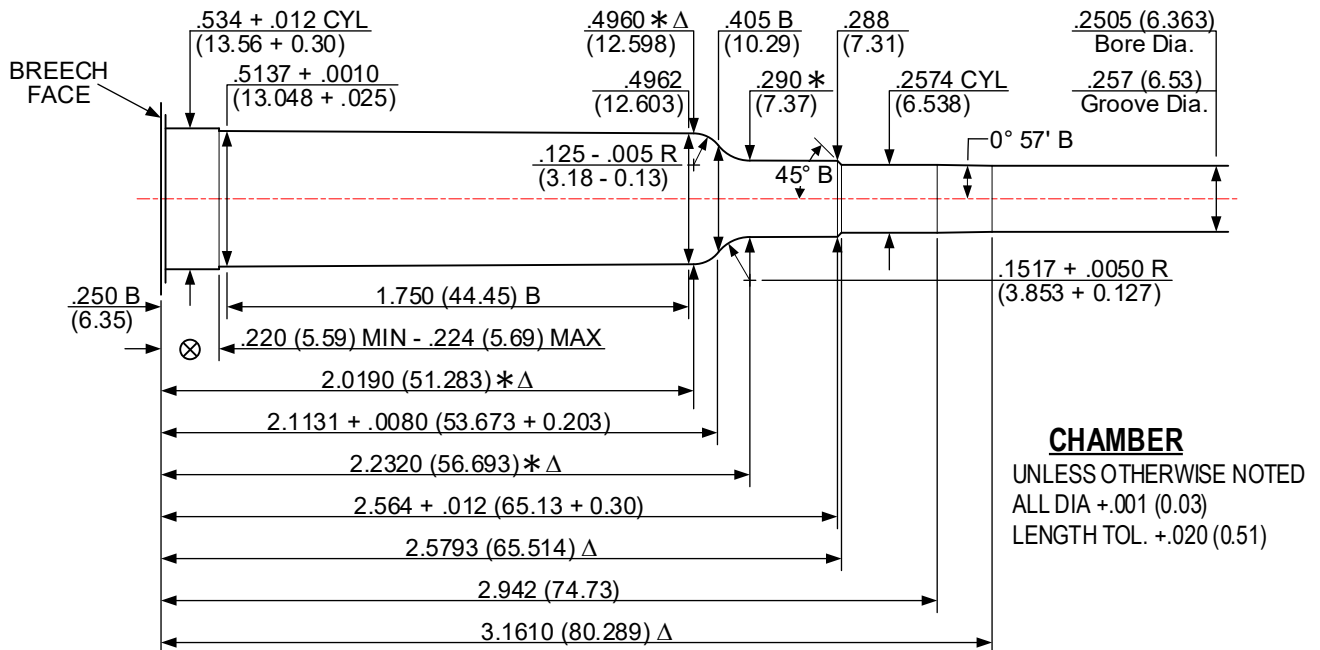
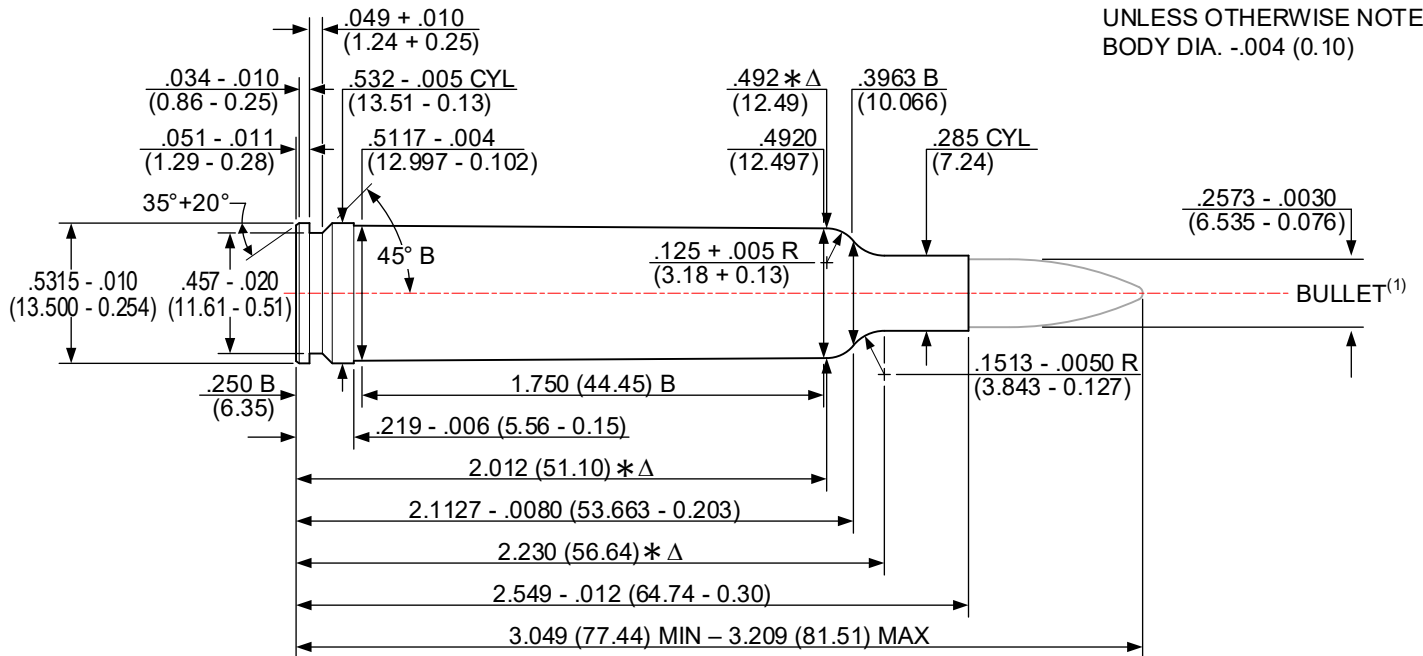

CHAMBER

UNLESS OTHERWISE NOTED
 ALL DIA +.001 (0.03)
 LENGTH TOL. +.020 (0.51)

Δ 6 GROOVES TWIST: 10.00 (254.0) R.H. OPTIONAL
 Δ .098+.002 (2.49+0.05) WIDE MINIMUM BORE & GROOVE AREA: .0512 in² (33.032 mm²)

NOTE:

B = BASIC (XX.XX) = MILLIMETERS ⊗ = HEADSPACE DIMENSION
 Δ = REFERENCE DIMENSION * = DIMENSIONS ARE TO INTERSECTION OF LINES
 ALL CALCULATIONS APPLY AT MAXIMUM MATERIAL CONDITION (MMC)
 (1) – BULLET PROFILE IS SHOWN FOR ILLUSTRATIVE PURPOSES ONLY

DO NOT SCALE FROM DRAWING

NOTICE: This drawing is subject to change.
 Revisions, if applicable, are available at www.saami.org.

ISSUED: 01/02/2014 **26 NOSLER (26 NOSLER)** REVISED: 05/03/2022

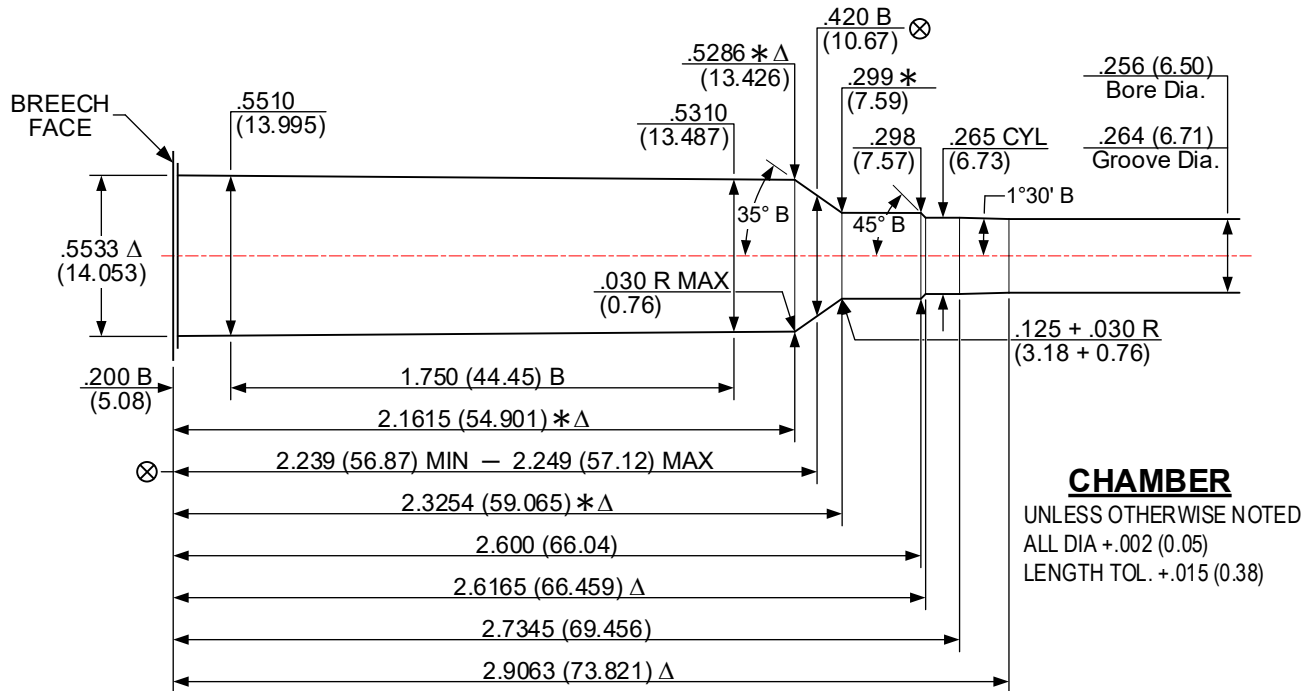
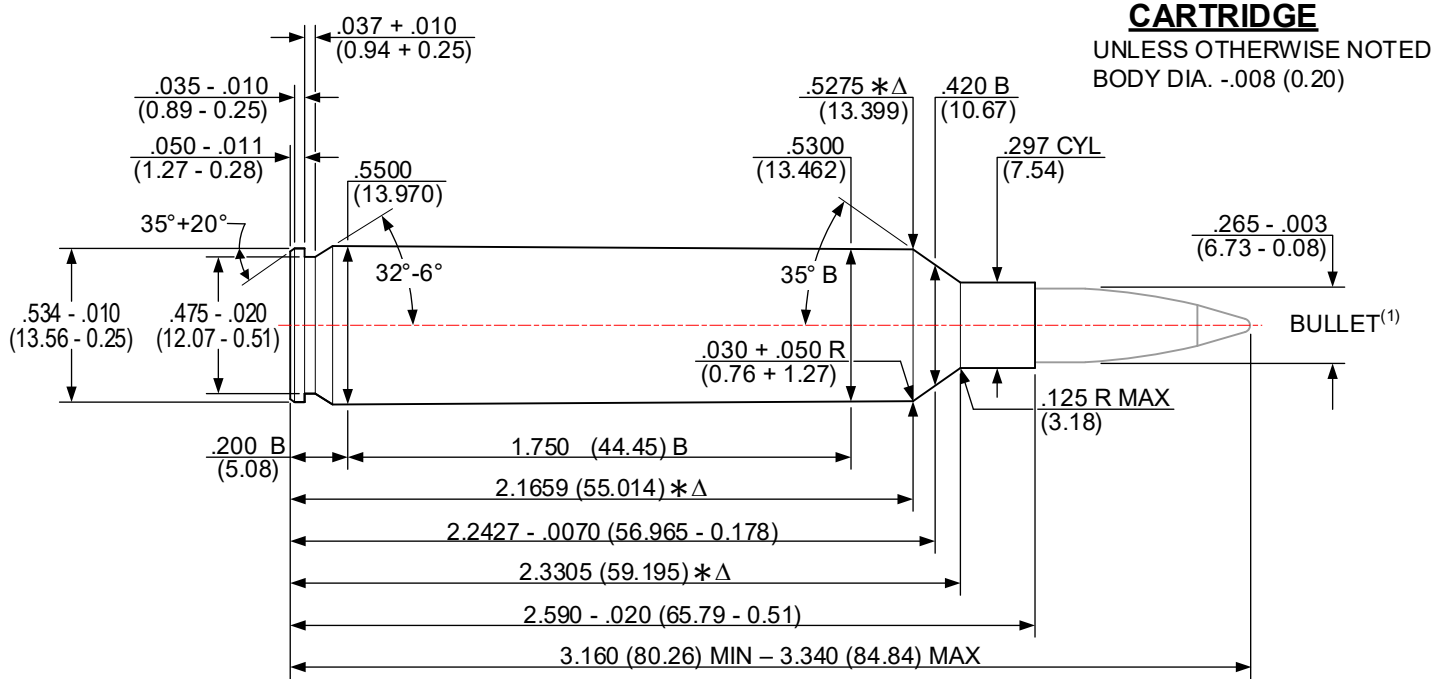

△ 4 GROOVES TWIST: 8.00 (203.2) R.H. OPTIONAL
 △ .095+.002 (2.41+0.05) WIDE MINIMUM BORE & GROOVE AREA: .0530 in² (34.193 mm²)

NOTES:
 B = BASIC (XX.XX) = MILLIMETERS ⊗ = HEAD SPACE DIMENSION
 △ = REFERENCE DIMENSION * = DIMENSIONS ARE TO INTERSECTION OF LINES
 ALL CALCULATIONS APPLY AT MAXIMUM MATERIAL CONDITION (MMC)
 (1) – BULLET PROFILE IS SHOWN FOR ILLUSTRATIVE PURPOSES ONLY

DO NOT SCALE FROM DRAWING

ISSUED: 01/29/1997 **260 REMINGTON [260 REM]** REVISED: 05/03/2022

CARTRIDGE

UNLESS OTHERWISE NOTED
 BODY DIA. -.008 (0.20)

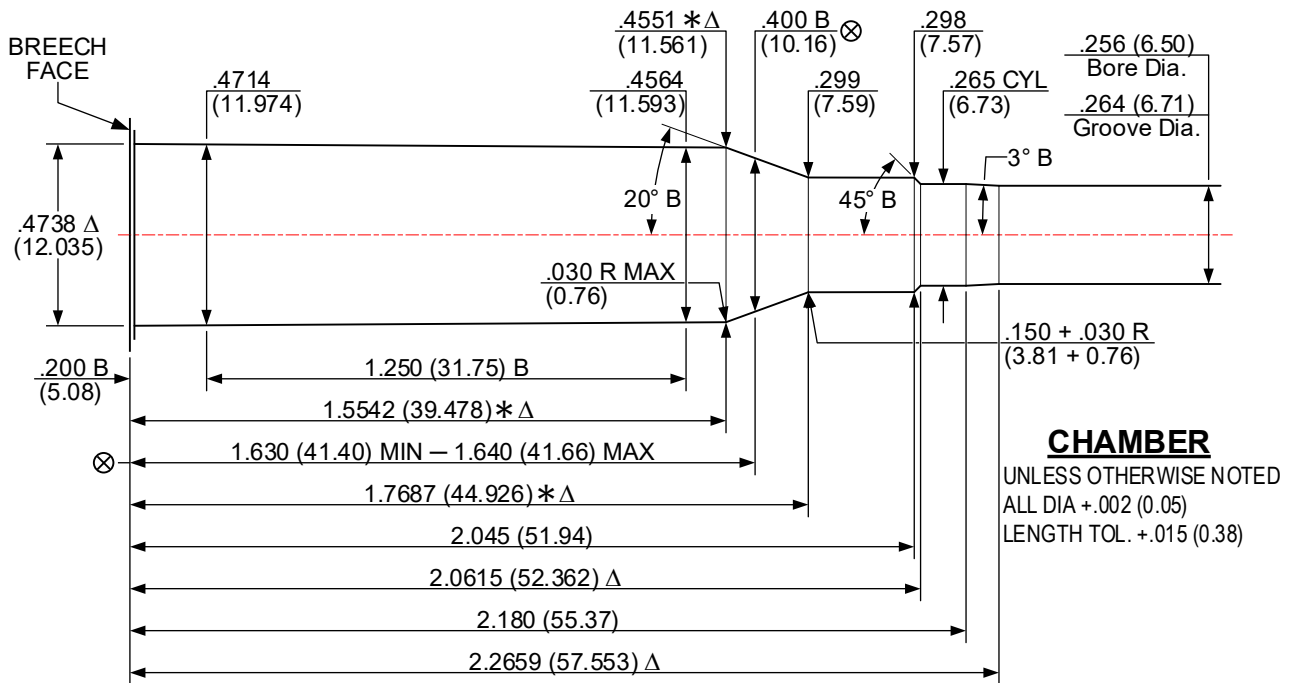
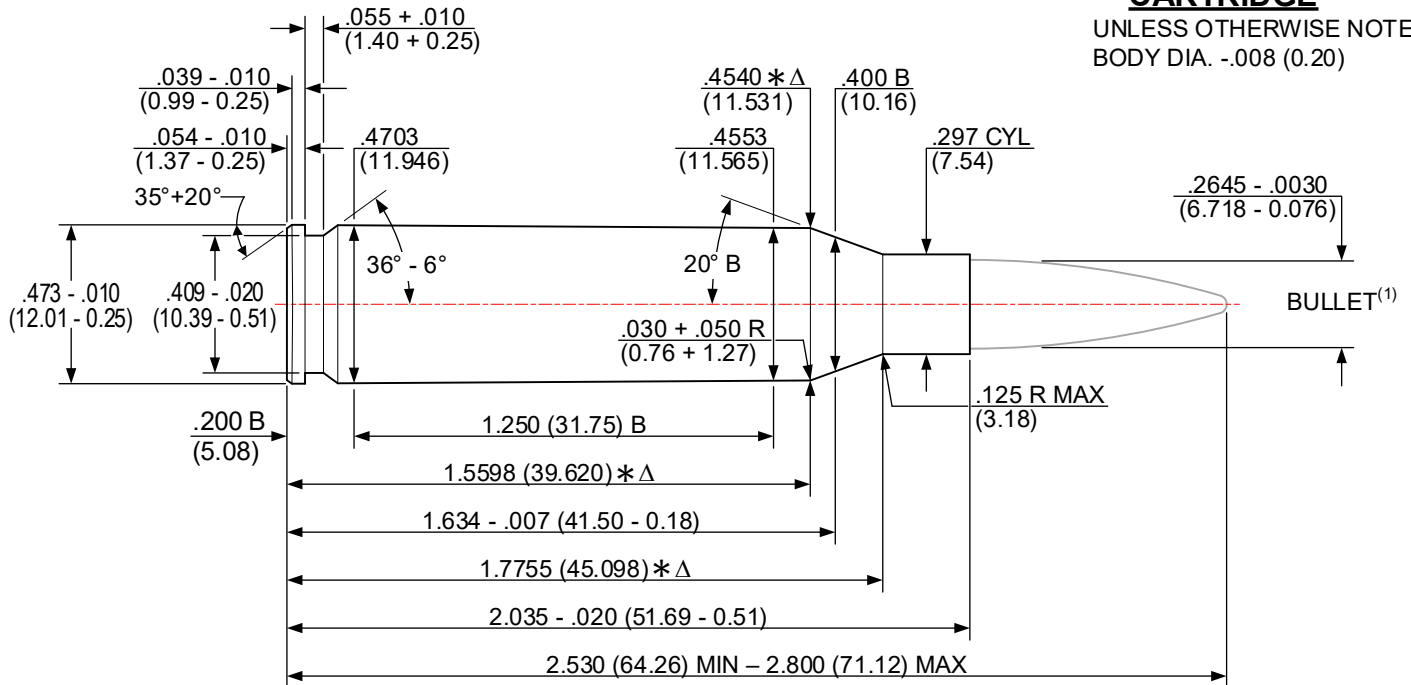

CHAMBER

UNLESS OTHERWISE NOTED
 ALL DIA +.002 (0.05)
 LENGTH TOL. +.015 (0.38)

Δ 6 GROOVES TWIST: 9.00 (228.6) R.H. OPTIONAL
 Δ .095+.002 (2.41+0.05) WIDE MINIMUM BORE & GROOVE AREA: .0538 in² (34.709 mm²)

NOTES:

- B = BASIC
- Δ = REFERENCE DIMENSION
- ALL CALCULATIONS APPLY AT MAXIMUM MATERIAL CONDITION (MMC)
- (1) – BULLET PROFILE IS SHOWN FOR ILLUSTRATIVE PURPOSES ONLY
- (XX.XX) = MILLIMETERS
- * = DIMENSIONS ARE TO INTERSECTION OF LINES
- ⊗ = HEAD SPACE DIMENSION

DO NOT SCALE FROM DRAWING

ISSUED: 04/21/1980 **264 WINCHESTER MAGNUM [264 WIN MAG]** REVISED: 08/29/2020

CARTRIDGE

UNLESS OTHERWISE NOTED
 BODY DIA. -.008 (0.20)

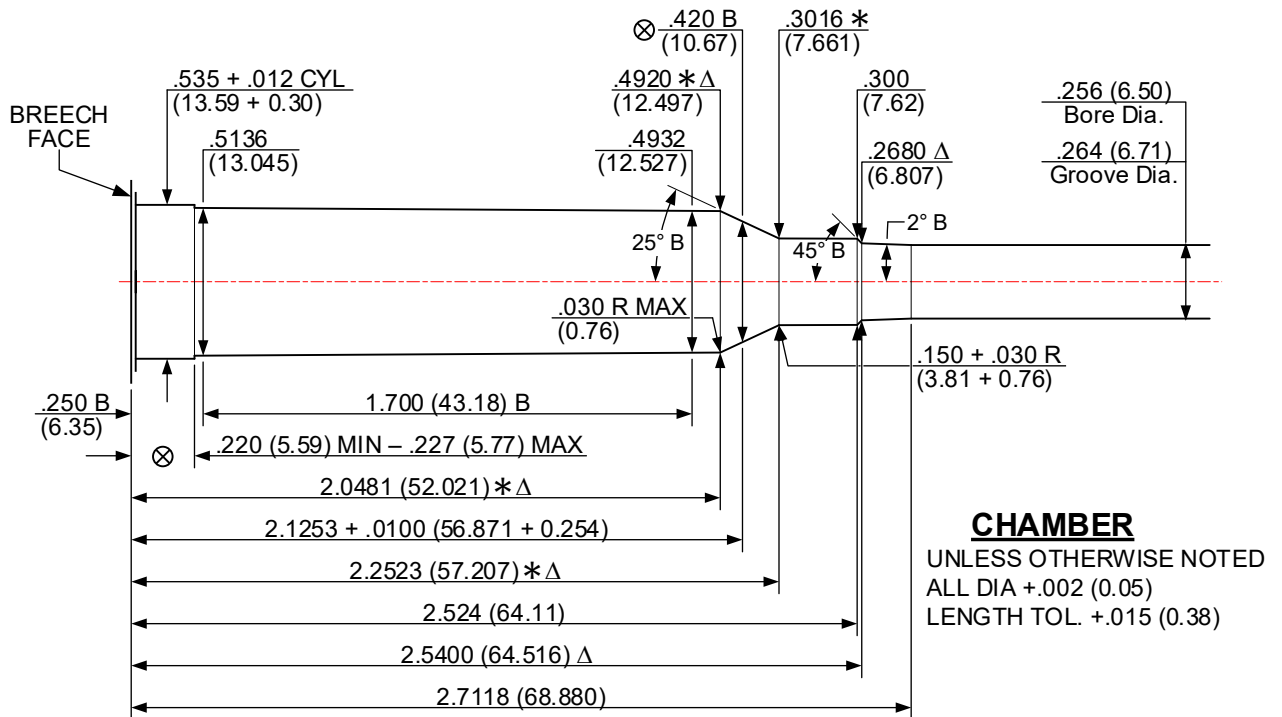
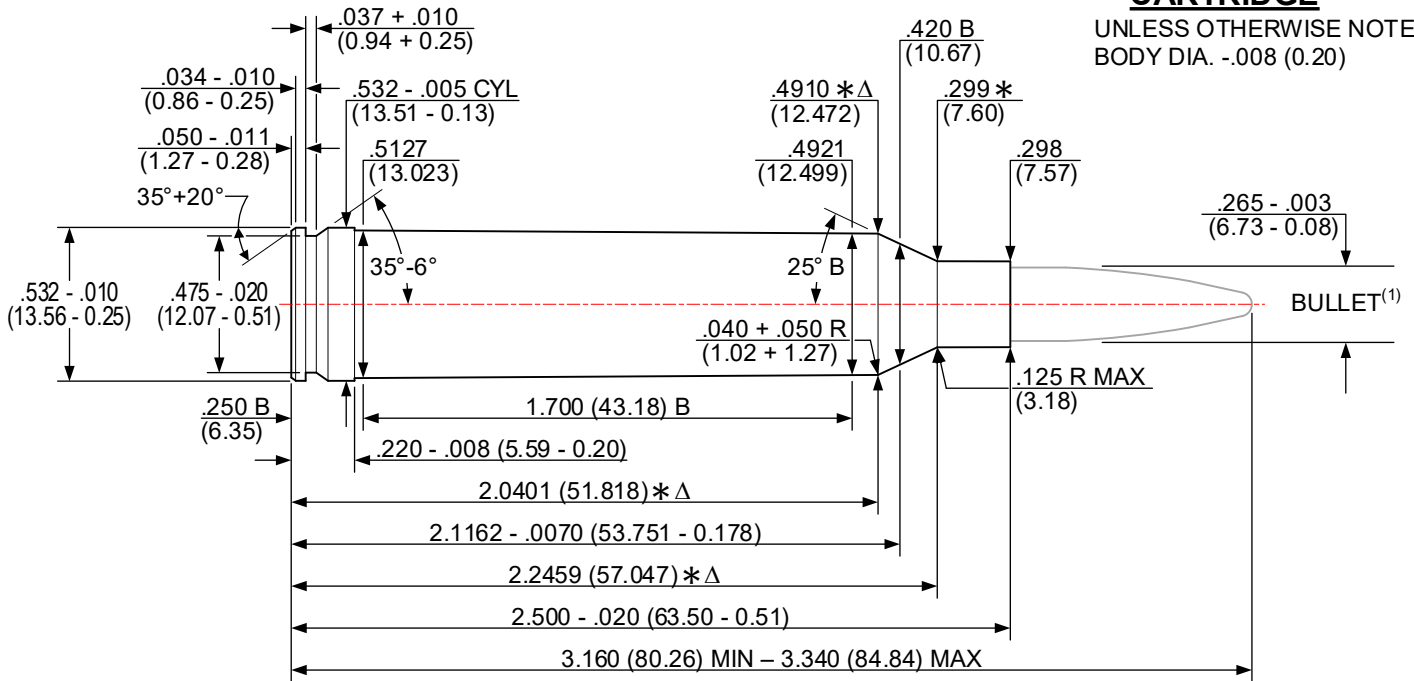

CHAMBER

UNLESS OTHERWISE NOTED
 ALL DIA +.002 (0.05)
 LENGTH TOL. +.015 (0.38)

△ 6 GROOVES TWIST: 9.00 (228.6) RH OPTIONAL
 △ .090+.002 (2.41+0.05) WIDE MINIMUM BORE & GROOVE AREA: .0536 in² (34.580 mm²)

NOTES:

- B = BASIC
- △ = REFERENCE DIMENSION
- ALL CALCULATIONS APPLY AT MAXIMUM MATERIAL CONDITION (MMC)
- (1) – BULLET PROFILE IS SHOWN FOR ILLUSTRATIVE PURPOSES ONLY
- (XX.XX) = MILLIMETERS
- * = DIMENSIONS ARE TO INTERSECTION OF LINES
- ⊗ = HEADSPACE DIMENSION

DO NOT SCALE FROM DRAWING

NOTICE: This drawing is subject to change.
 Revisions, if applicable, are available at www.saami.org.

ISSUED: 01/26/2015 **27 NOSLER [27 NOSLER]** REVISED: 05/04/2022

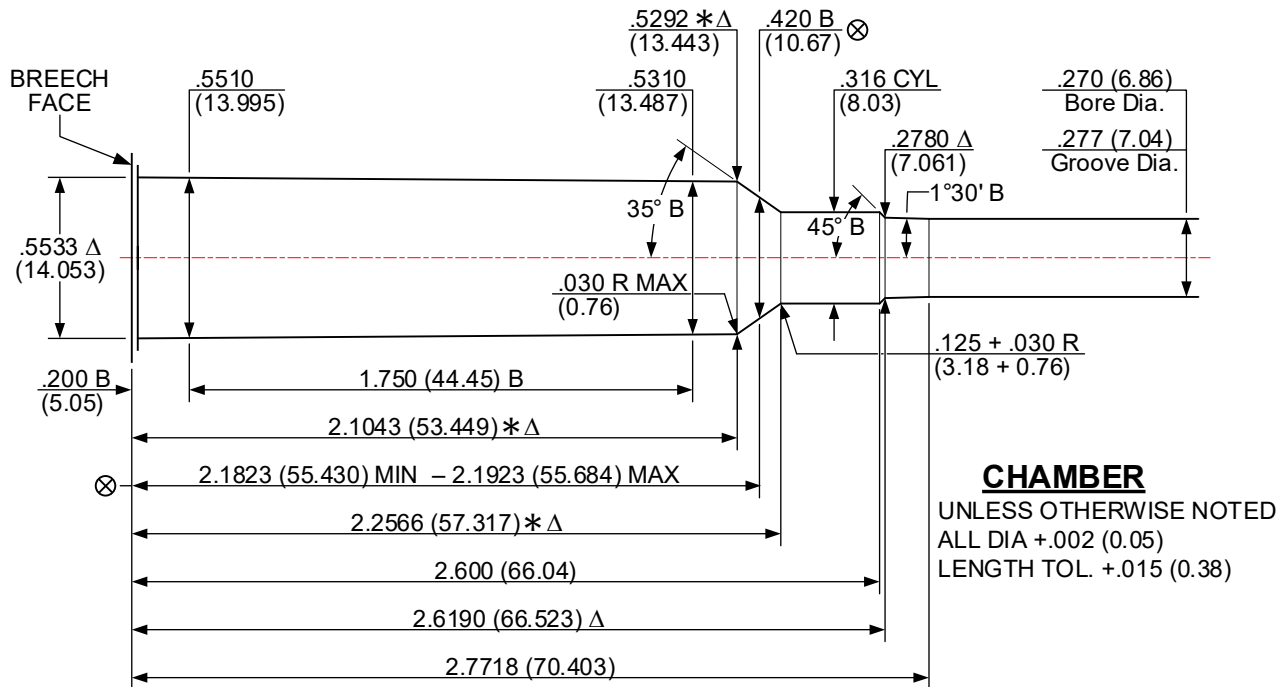
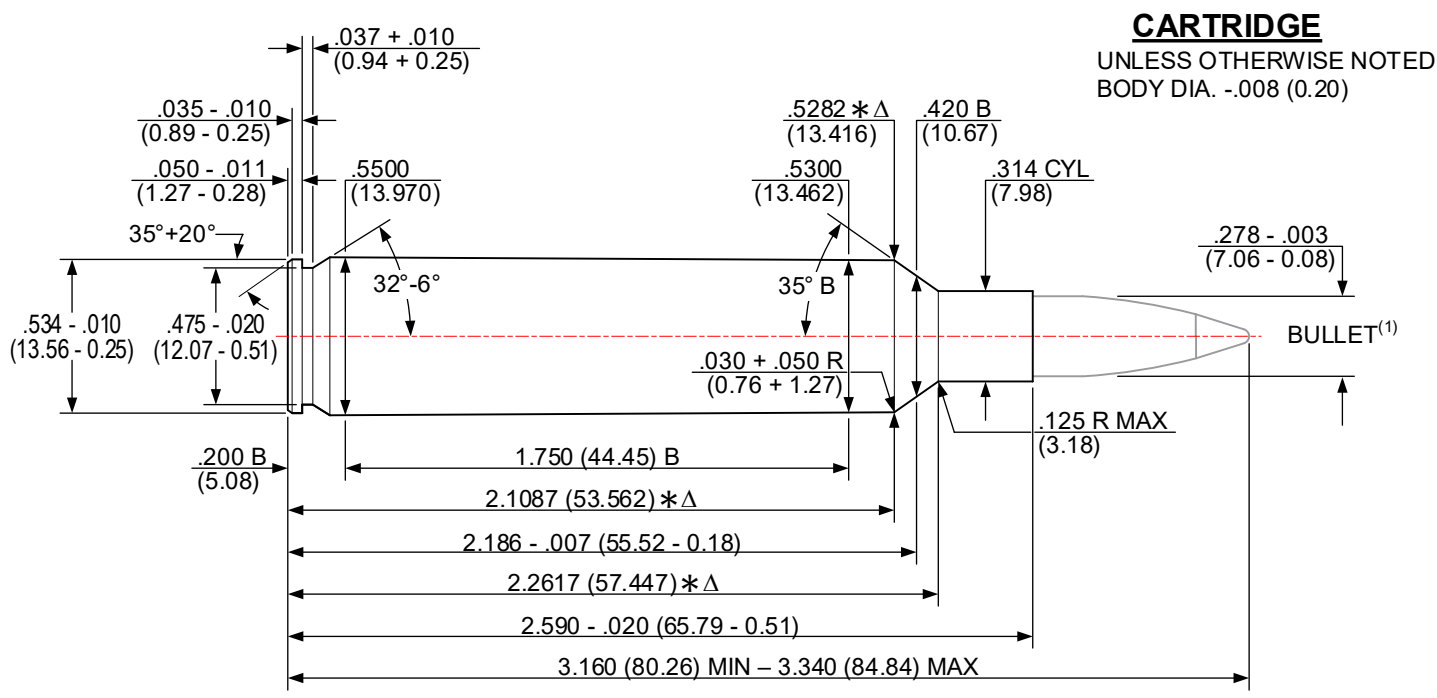

Δ 4 GROOVES TWIST: 8.50 (215.9) RH OPTIONAL
 Δ .160+.002 (4.06+0.05) WIDE MINIMUM BORE & GROOVE AREA: .0596 in² (38.451 mm²)

NOTES:
 B = BASIC (XX.XX) = MILLIMETERS ⊗ = HEADSPACE DIMENSION
 Δ = REFERENCE DIMENSION * = DIMENSIONS ARE TO INTERSECTION OF LINES
 ALL CALCULATIONS APPLY AT MAXIMUM MATERIAL CONDITION (MMC)
 (1) – BULLET PROFILE IS SHOWN FOR ILLUSTRATIVE PURPOSES ONLY

DO NOT SCALE FROM DRAWING

NOTICE: This drawing is subject to change.
 Revisions, if applicable, are available at www.saami.org.

ISSUED: 01/12/1994 **270 WEATHERBY MAGNUM [270 WBY MAG]** REVISED: 01/21/2024

CARTRIDGE

UNLESS OTHERWISE NOTED
 BODY DIA. -.004 (0.10)

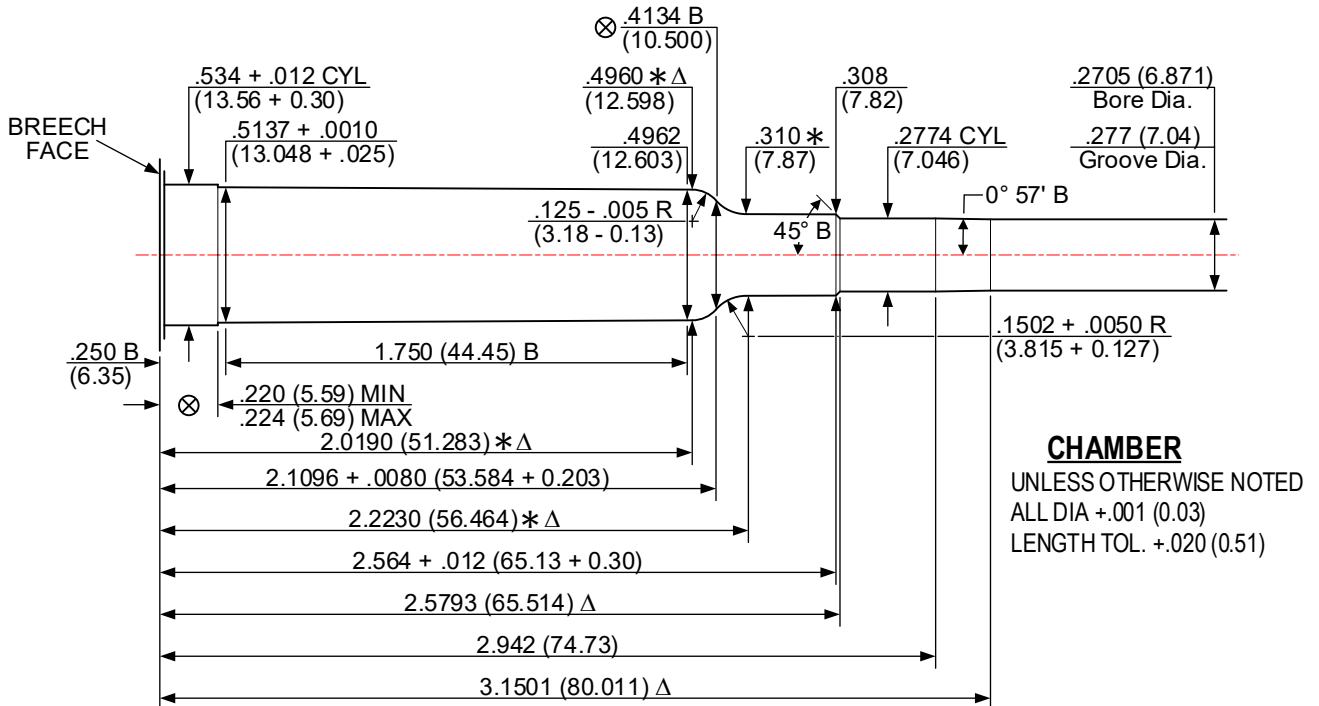
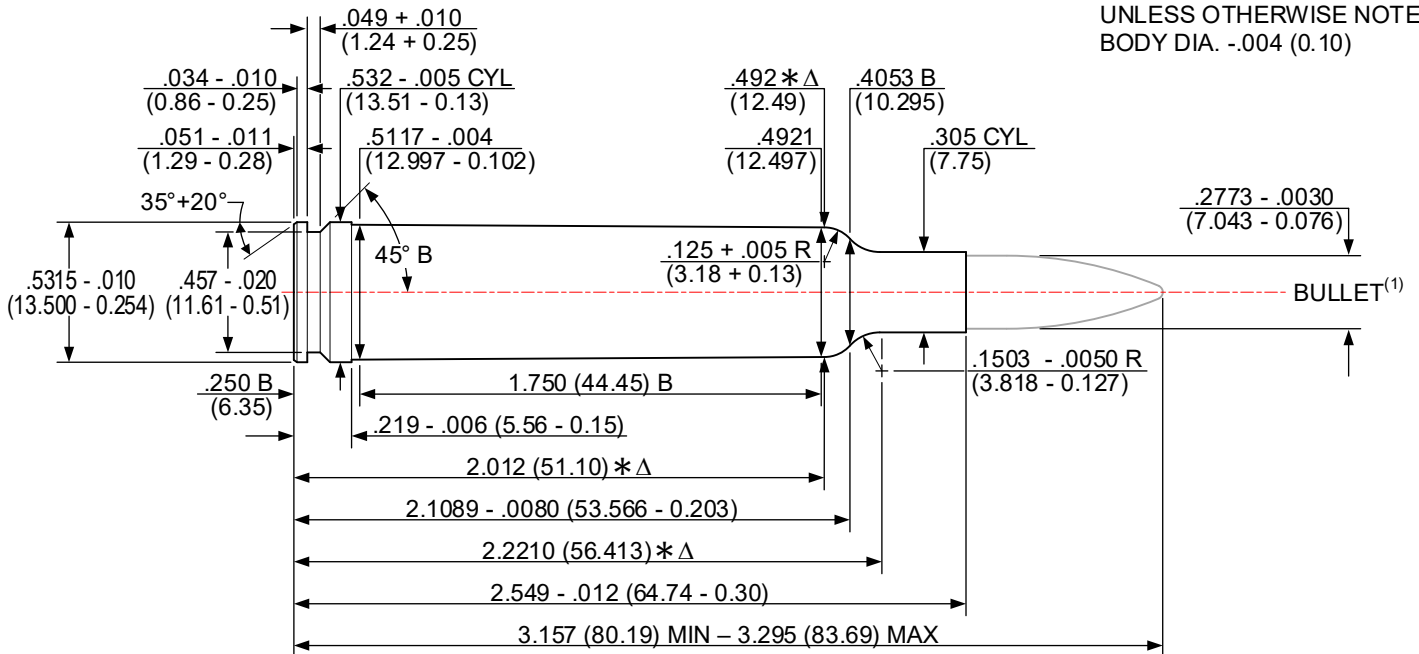

Δ 6 GROOVES TWIST: 10.00 (254.0) R.H. OPTIONAL
 Δ .108+.002 (2.74+0.05) WIDE MINIMUM BORE & GROOVE AREA: .0596 in² (38.451 mm²)

NOTE:
 B = BASIC (XX.XX) = MILLIMETERS \varnothing = HEADSPACE DIMENSION
 Δ = REFERENCE DIMENSION * = DIMENSIONS ARE TO INTERSECTION OF LINES
 ALL CALCULATIONS APPLY AT MAXIMUM MATERIAL CONDITION (MMC)
 (1) – BULLET PROFILE IS SHOWN FOR ILLUSTRATIVE PURPOSES ONLY

DO NOT SCALE FROM DRAWING

ISSUED: 05/29/1979 **270 WINCHESTER [270 WIN]** REVISED: 05/04/2022

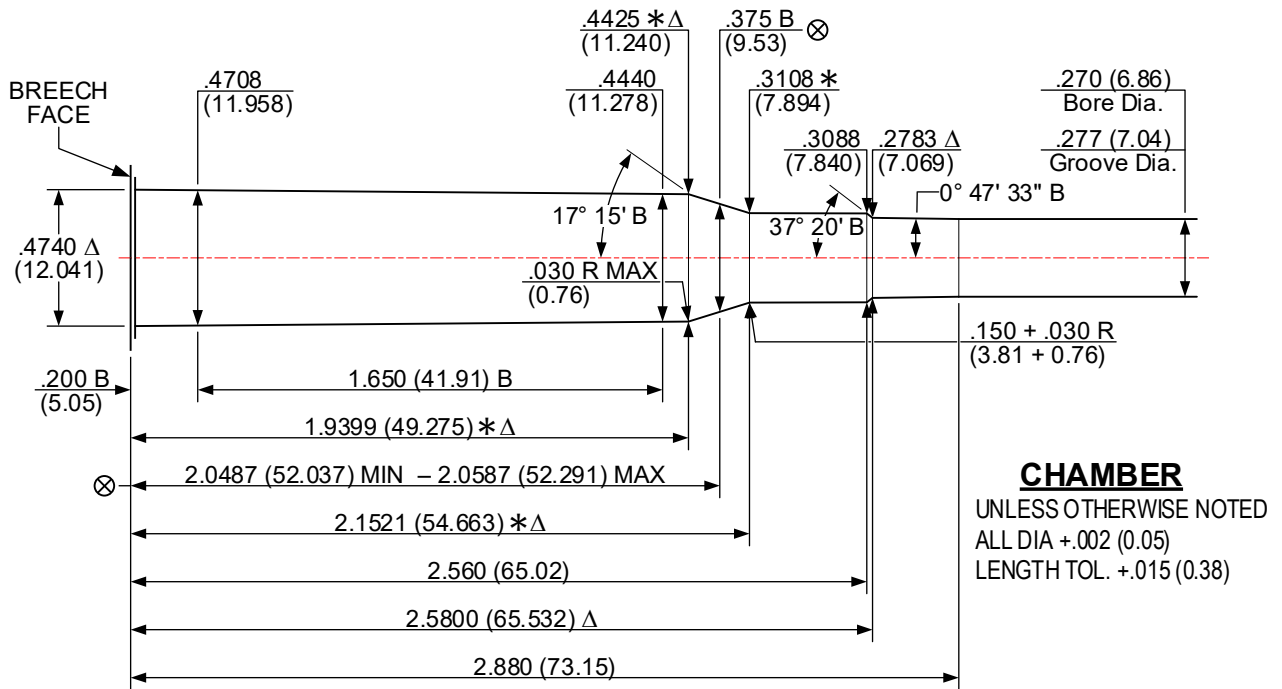
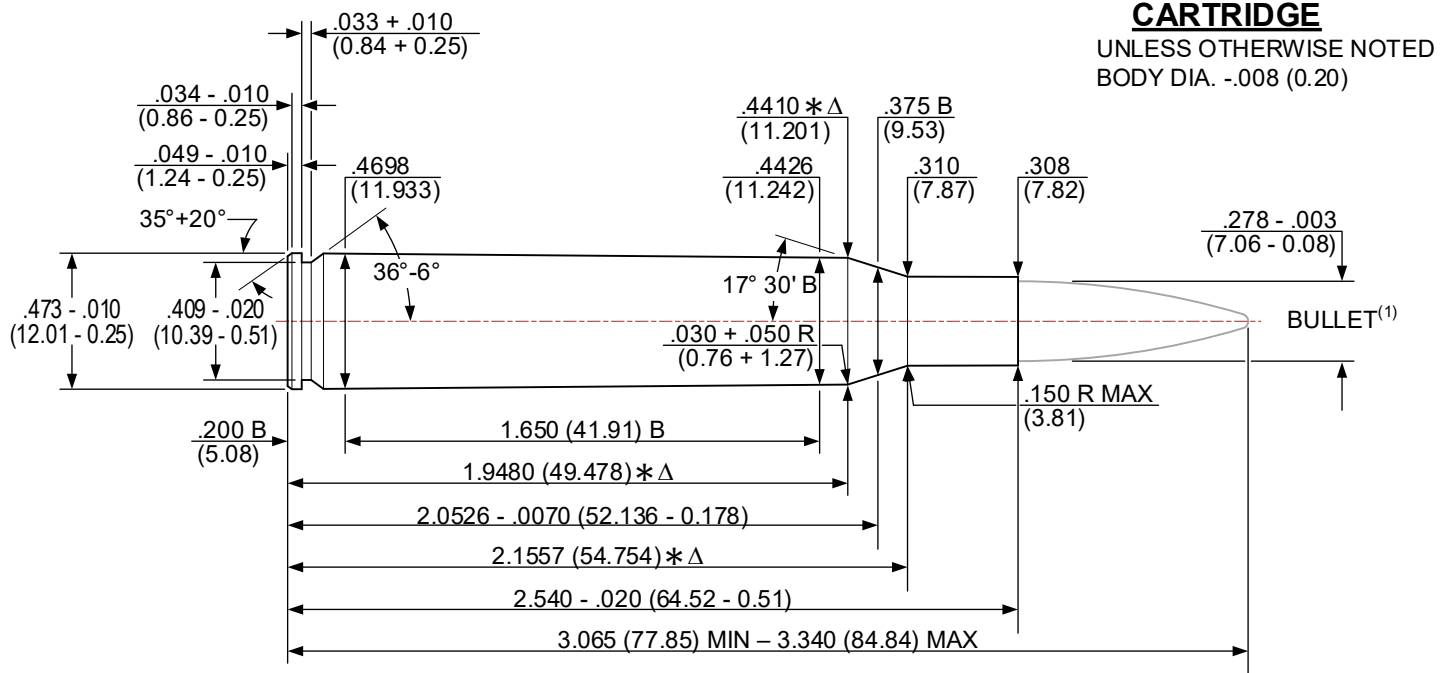

Δ 4 GROOVES TWIST: 10.00 (254.0) RH OPTIONAL
 Δ .160+.002 (4.06+0.05) WIDE MINIMUM BORE & GROOVE AREA: .0596 in² (38.451 mm²)

NOTES:

- B = BASIC
- Δ = REFERENCE DIMENSION
- ALL CALCULATIONS APPLY AT MAXIMUM MATERIAL CONDITION (MMC)
- (1) – BULLET PROFILE IS SHOWN FOR ILLUSTRATIVE PURPOSES ONLY
- (XX.XX) = MILLIMETERS
- * = DIMENSIONS ARE TO INTERSECTION OF LINES
- ⊗ = HEADSPACE DIMENSION

DO NOT SCALE FROM DRAWING

NOTICE: This drawing is subject to change. Revisions, if applicable, are available at www.saami.org.

ISSUED: 02/01/2002 **270 WINCHESTER SHORT MAGNUM [270 WSM]** REVISED: 11/15/2021

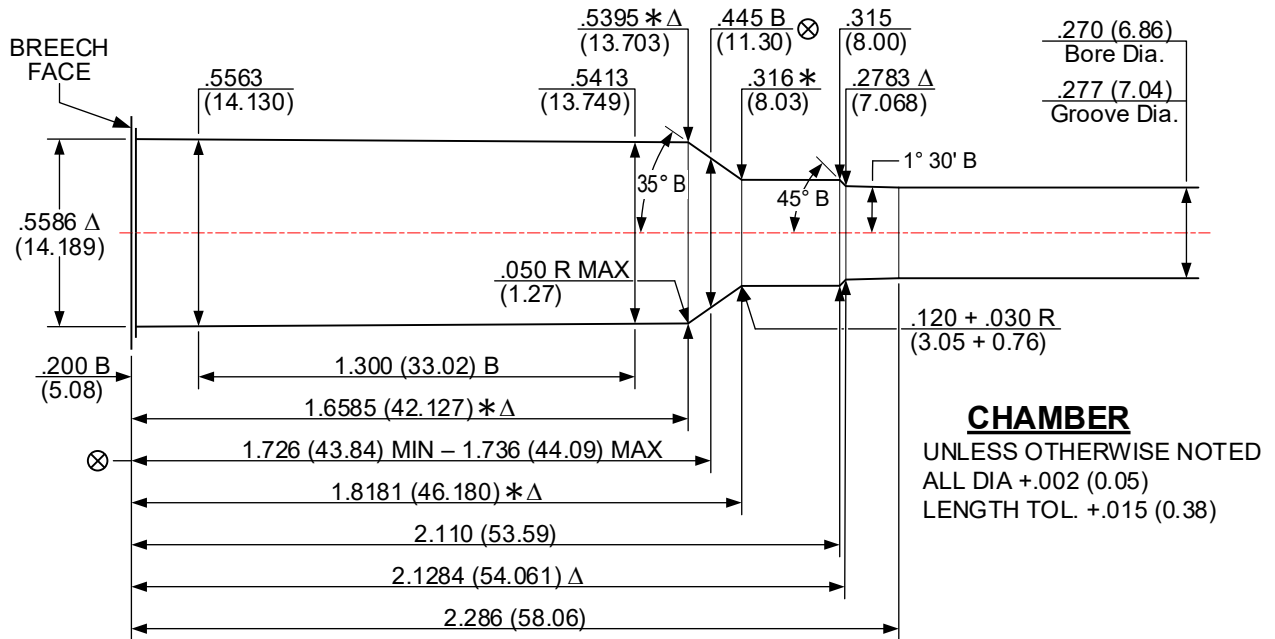
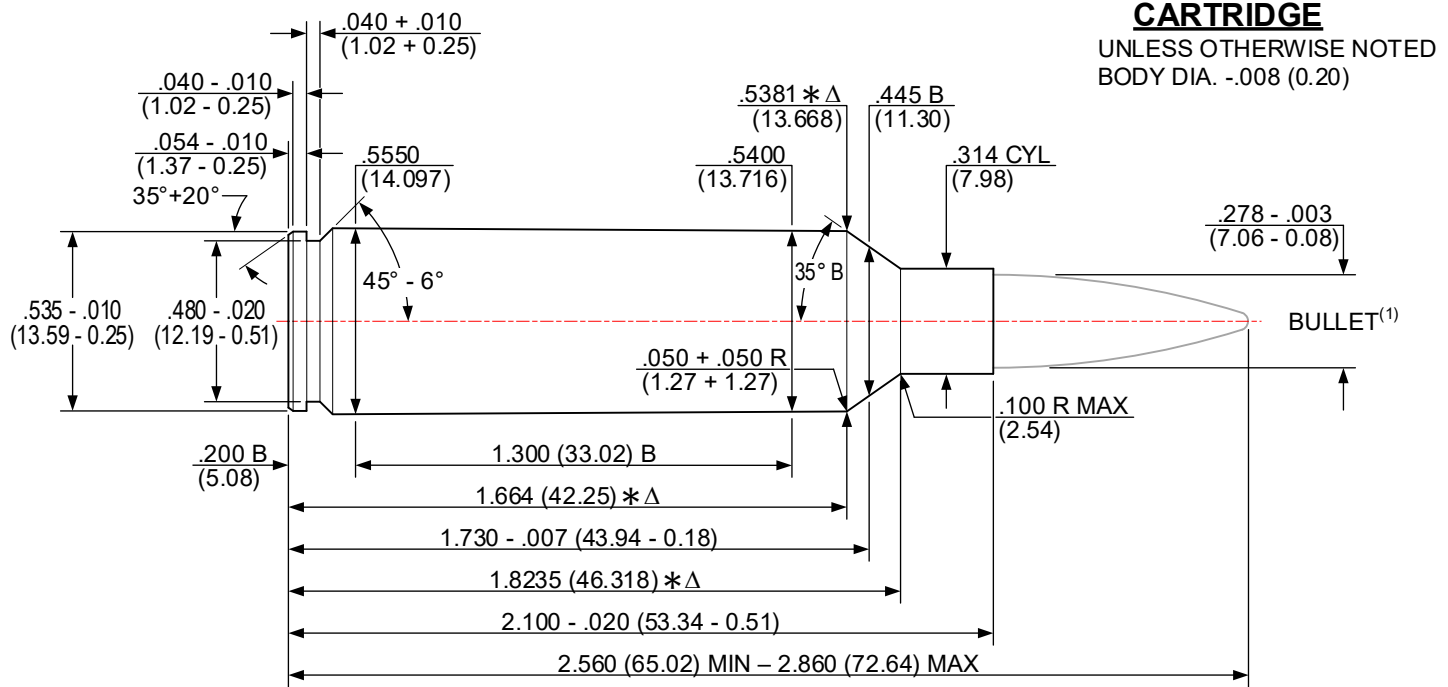

Δ 4 GROOVES TWIST: 10.00 (254.0) RH OPTIONAL
 Δ .160+.002 (4.06+0.05) WIDE MINIMUM BORE & GROOVE AREA: .0596 in² (38.451 mm²)

NOTES:

- B = BASIC
- Δ = REFERENCE DIMENSION
- ALL CALCULATIONS APPLY AT MAXIMUM MATERIAL CONDITION (MMC)
- (1) – BULLET PROFILE IS SHOWN FOR ILLUSTRATIVE PURPOSES ONLY
- (XX.XX) = MILLIMETERS
- * = DIMENSIONS ARE TO INTERSECTION OF LINES
- ⊗ = HEADSPACE DIMENSION

DO NOT SCALE FROM DRAWING

NOTICE: This drawing is subject to change.
 Revisions, if applicable, are available at www.saami.org.

ISSUED: 09/23/2020 **277 SIG FURY [277 SIG FURY]** REVISED: 05/04/2022

WARNING: Maximum Average Pressure levels greater than 65,000 psi may present increased risk of unsafe cartridge case or firearm rupture and thus require cartridge case and/or firearm designs that depart from traditional practices (materials, construction, and other design criteria).

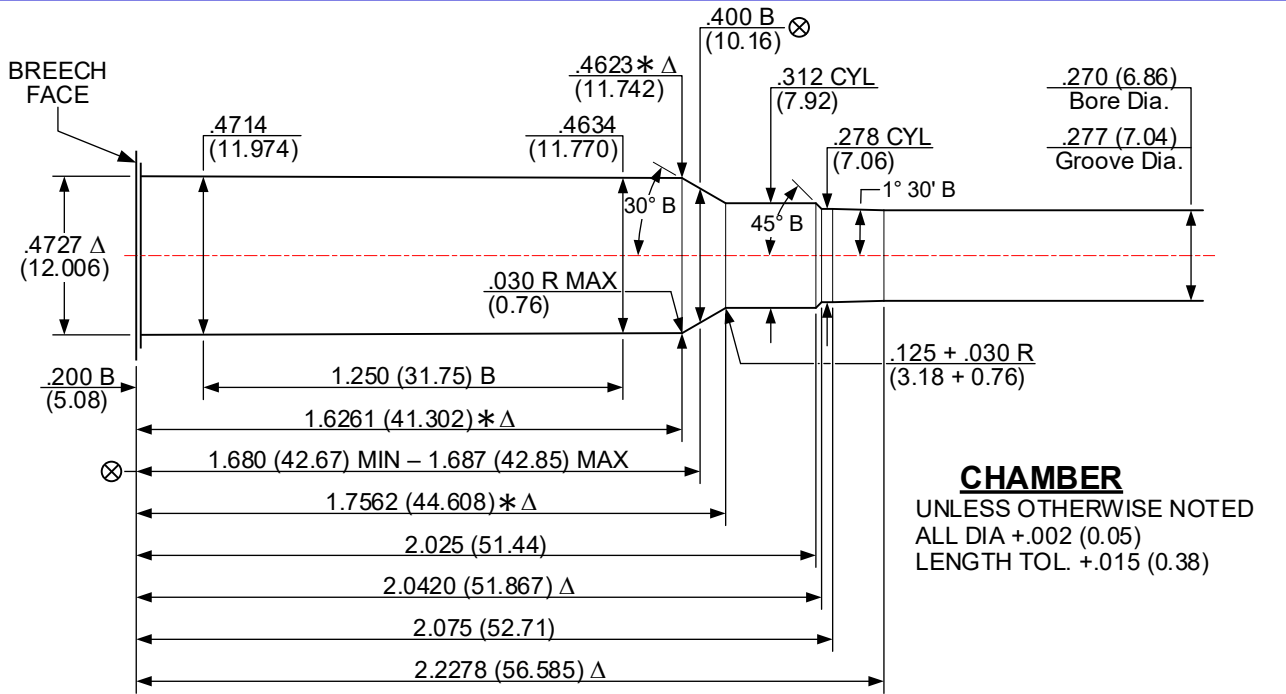
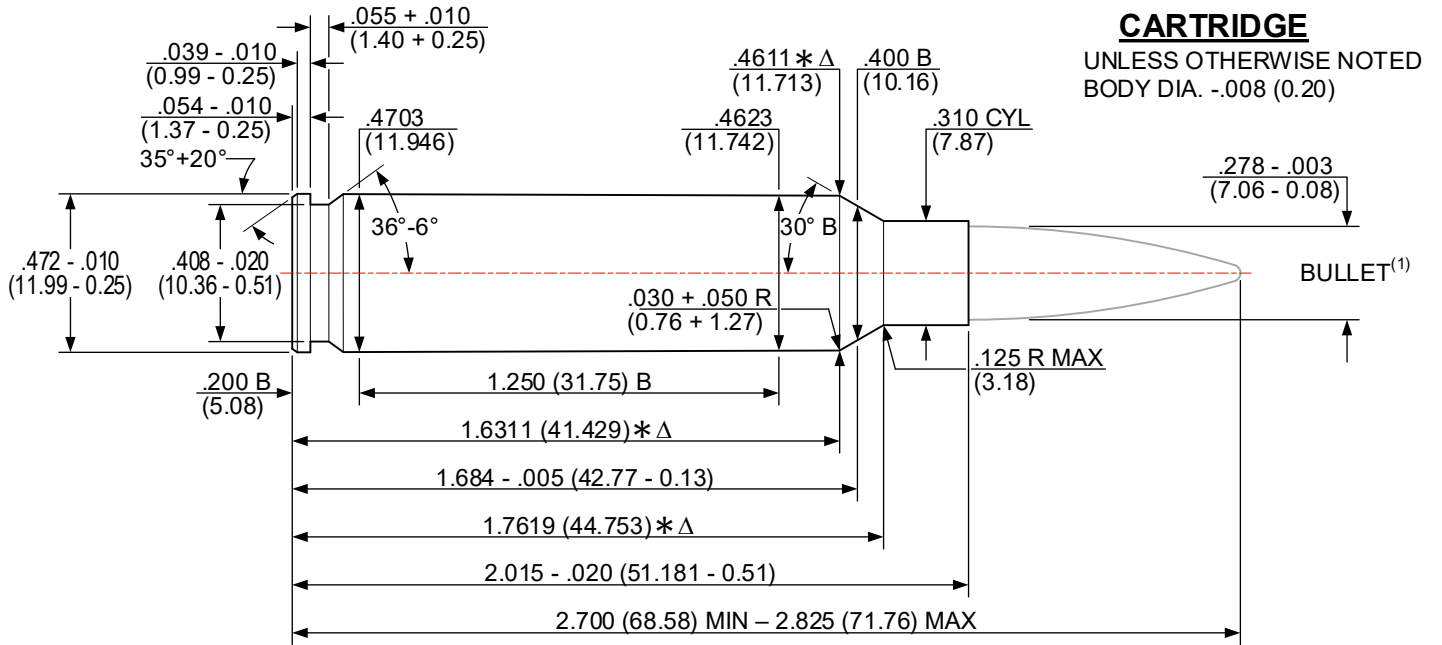

△ 6 GROOVES TWIST: 7.00 (177.8) RH OPTIONAL
 △ .108+.002 (2.74+0.05) WIDE MINIMUM BORE & GROOVE AREA: .0595 in² (38.387 mm²)

NOTES:
 B = BASIC (XX.XX) = MILLIMETERS ⊗ = HEADSPACE DIMENSION
 △ = REFERENCE DIMENSION * = DIMENSIONS ARE TO INTERSECTION OF LINES
 ALL CALCULATIONS APPLY AT MAXIMUM MATERIAL CONDITION (MMC)
 (1) – BULLET PROFILE IS SHOWN FOR ILLUSTRATIVE PURPOSES ONLY

DO NOT SCALE FROM DRAWING

NOTICE: This drawing is subject to change.
 Revisions, if applicable, are available at www.saami.org.

ISSUED: 01/18/2015 **28 NOSLER [28 NOSLER]** REVISED: 05/05/2022

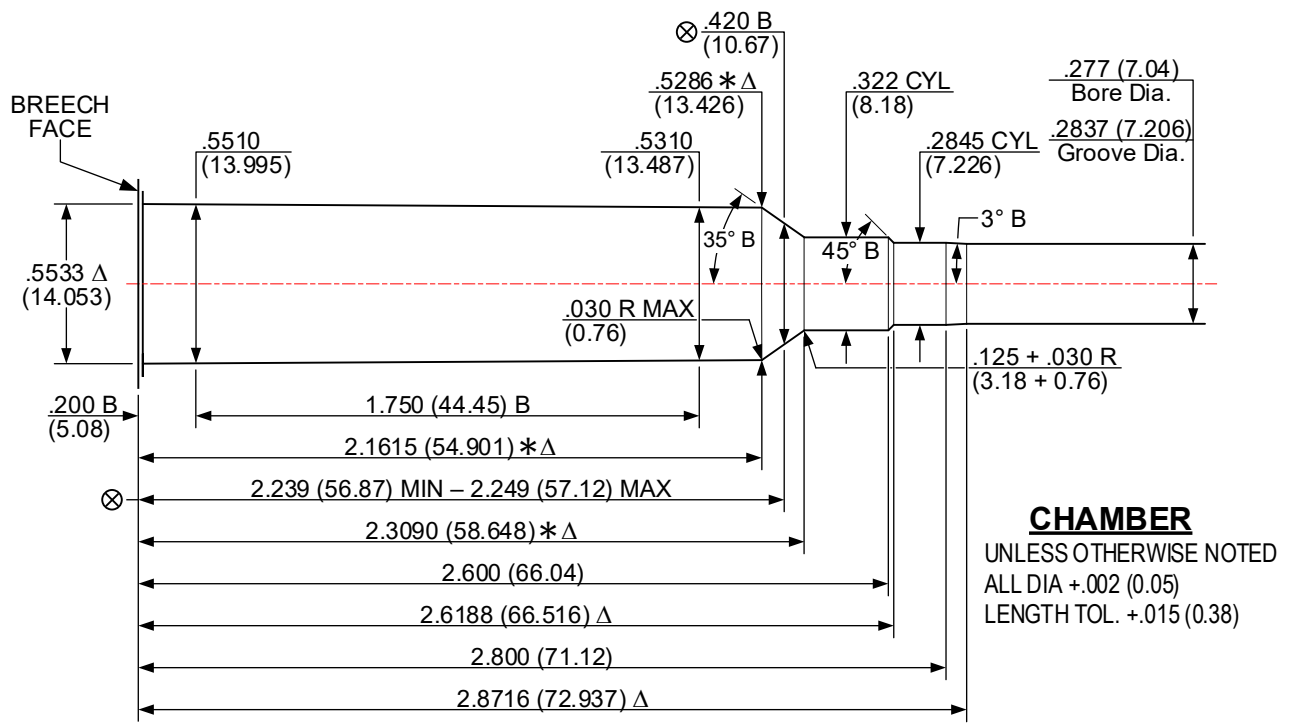
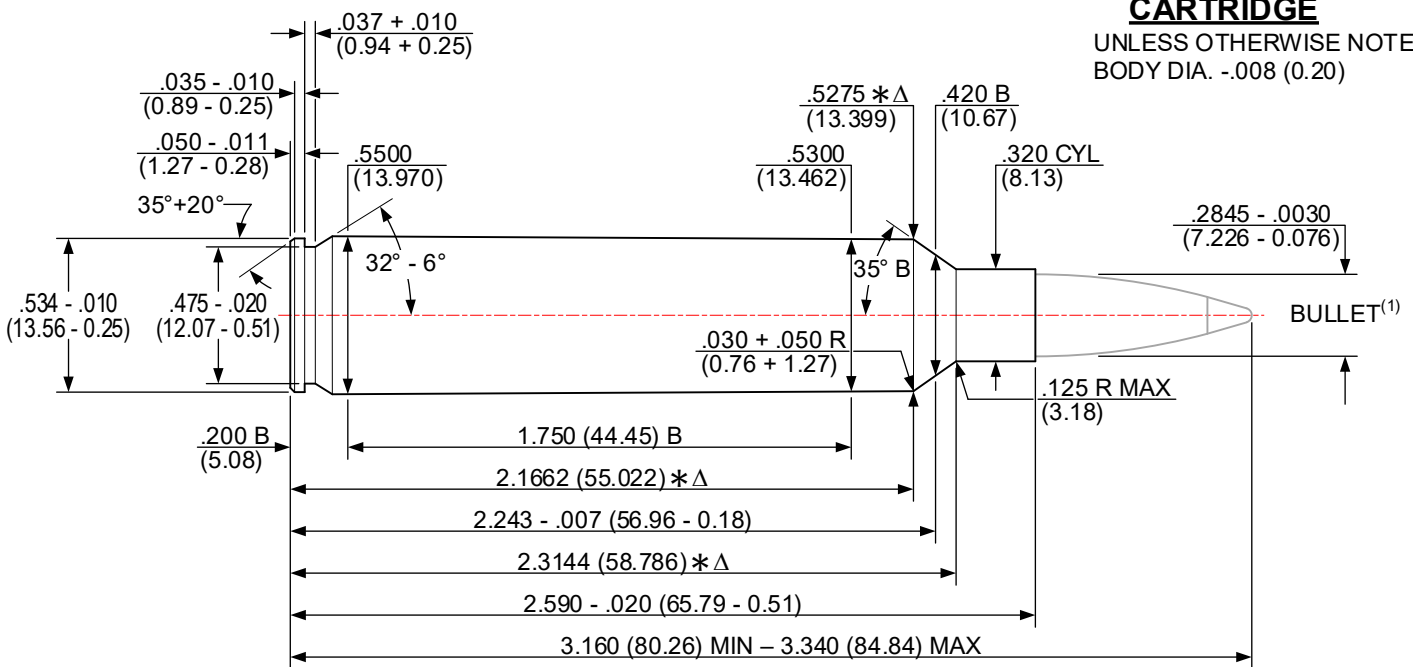

△ 6 GROOVES TWIST: 9.00 (228.6) RH OPTIONAL
 △ .110+.002 (2.79+0.05) WIDE MINIMUM BORE & GROOVE AREA: .0625 in² (40.322 mm²)

NOTES:

- B = BASIC (XX.XX) = MILLIMETERS ⊗ = HEADSPACE DIMENSION
- △ = REFERENCE DIMENSION * = DIMENSIONS ARE TO INTERSECTION OF LINES
- ALL CALCULATIONS APPLY AT MAXIMUM MATERIAL CONDITION (MMC)
- (1) – BULLET PROFILE IS SHOWN FOR ILLUSTRATIVE PURPOSES ONLY

DO NOT SCALE FROM DRAWING

NOTICE: This drawing is subject to change.
 Revisions, if applicable, are available at www.saami.org.

ISSUED: 02/01/2008 **280 ACKLEY IMPROVED [280 ACK IMP]** REVISED: 05/05/2022

CARTRIDGE

UNLESS OTHERWISE NOTED
 BODY DIA. -.008 (0.20)

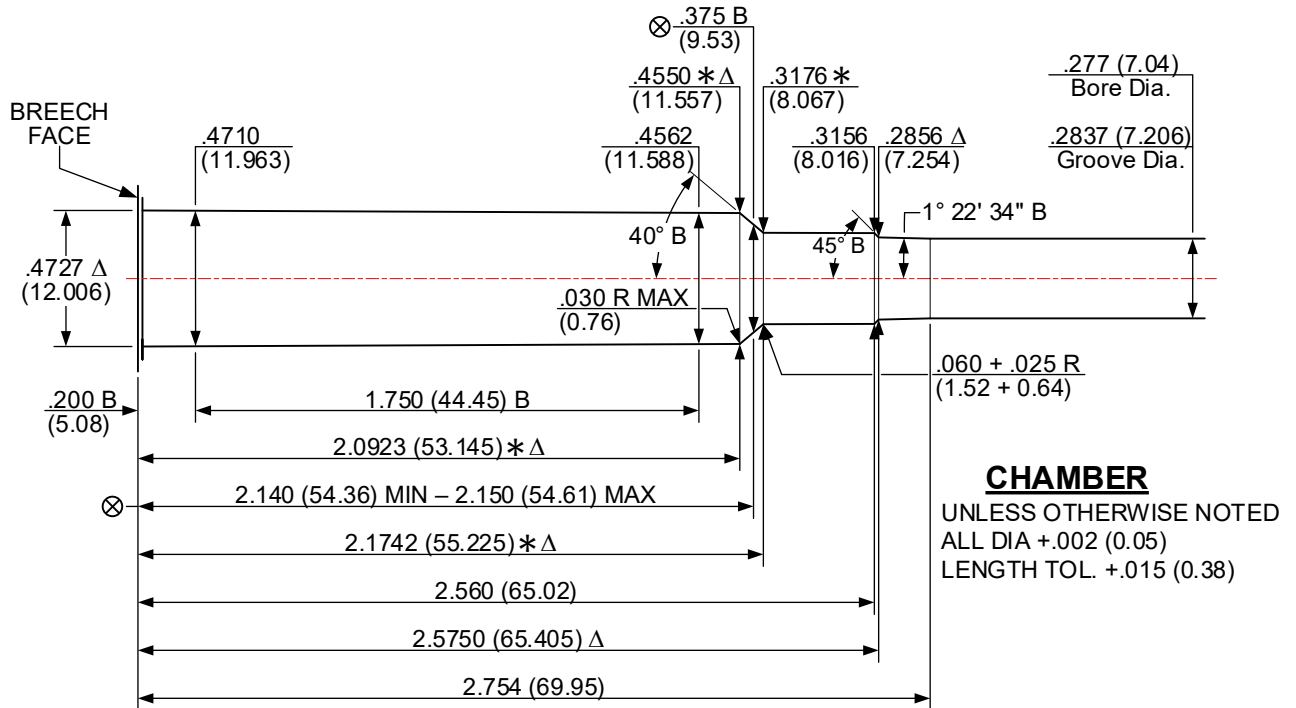
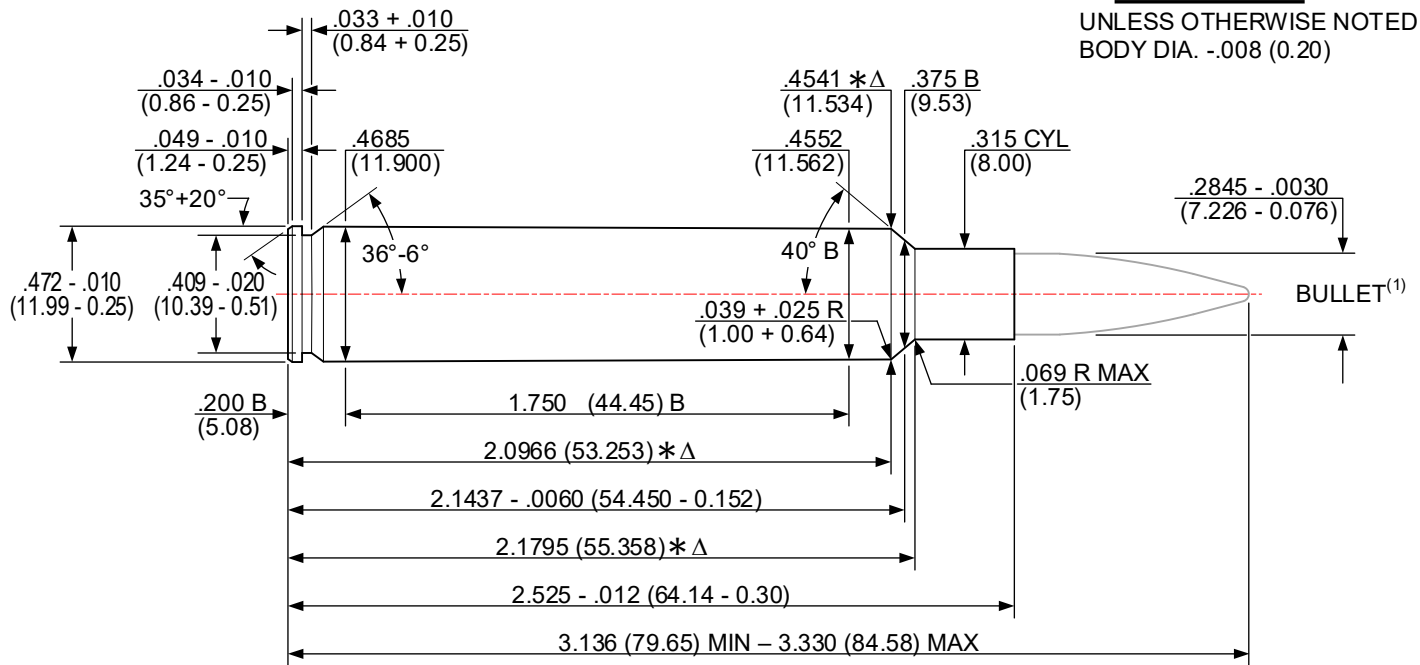

CHAMBER

UNLESS OTHERWISE NOTED
 ALL DIA +.002 (0.05)
 LENGTH TOL. +.015 (0.38)

Δ 4 GROOVES TWIST: 9.00 (228.6) RH OPTIONAL
 Δ .160+.002 (4.06+0.05) WIDE MINIMUM BORE & GROOVE AREA: .0625 in² (40.322 mm²)

NOTES:

- B = BASIC (XX.XX) = MILLIMETERS ⊗ = HEADSPACE DIMENSION
- Δ = REFERENCE DIMENSION * = DIMENSIONS ARE TO INTERSECTION OF LINES
- ALL CALCULATIONS APPLY AT MAXIMUM MATERIAL CONDITION (MMC)
- (1) – BULLET PROFILE IS SHOWN FOR ILLUSTRATIVE PURPOSES ONLY

DO NOT SCALE FROM DRAWING

NOTICE: This drawing is subject to change.
 Revisions, if applicable, are available at www.saami.org.

ISSUED: 06/20/1986 **280 REMINGTON [280 REM]** REVISED: 05/05/2022
PREVIOUSLY DESIGNATED 7MM EXPRESS REMINGTON [7MM EXP REM]

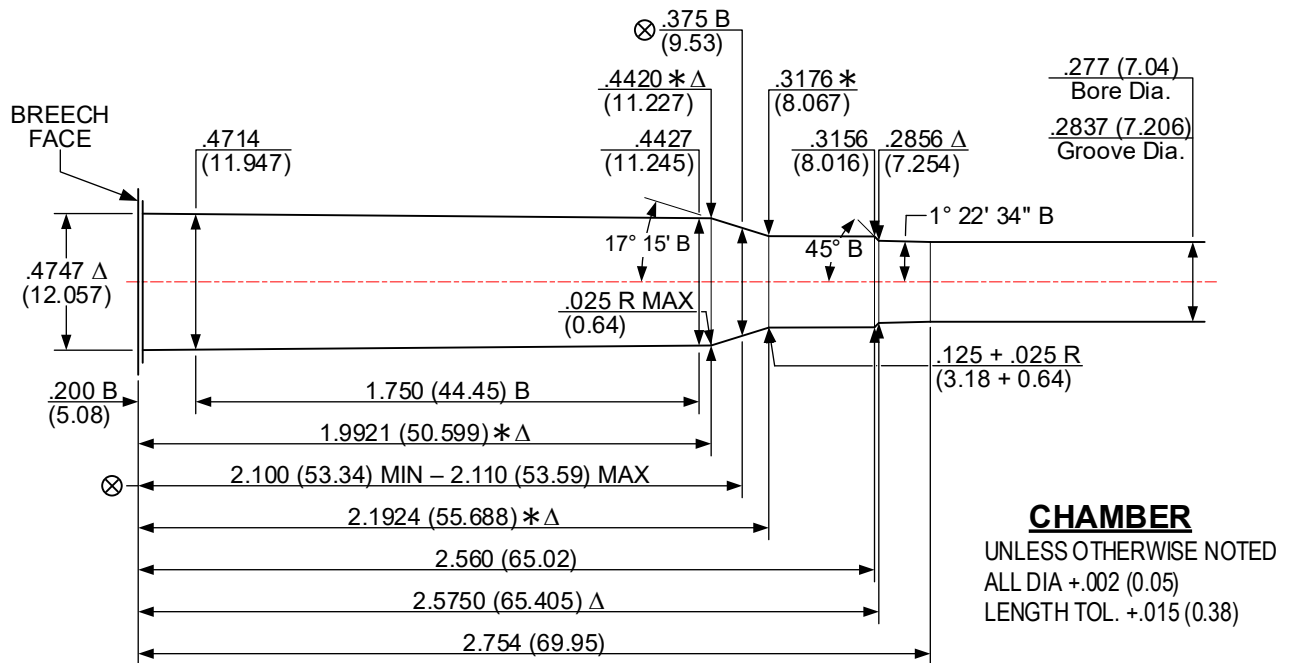
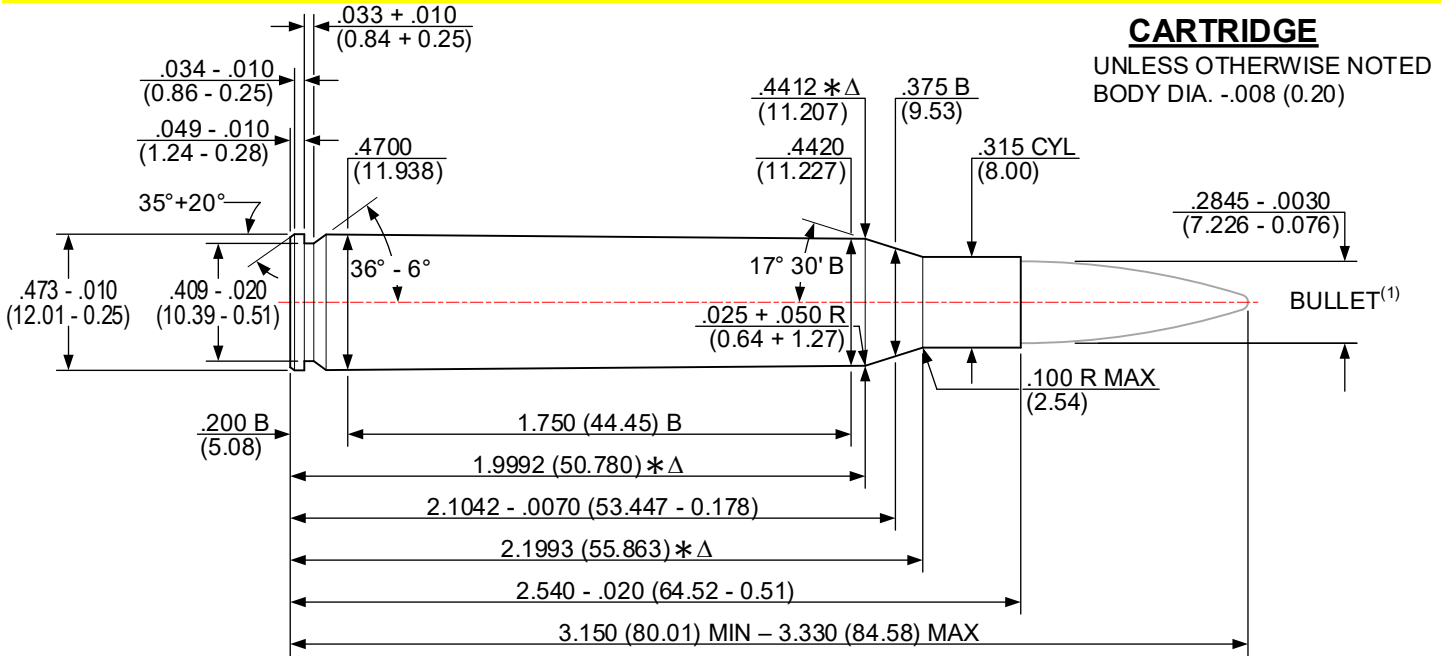

Δ 4 GROOVES TWIST: 10.00 (254.0) RH OPTIONAL
 Δ .160+.002 (4.06+0.05) WIDE MINIMUM BORE & GROOVE AREA: .0625 in² (40.322 mm²)

NOTES:

- B = BASIC
- Δ = REFERENCE DIMENSION
- ALL CALCULATIONS APPLY AT MAXIMUM MATERIAL CONDITION (MMC)
- (1) – BULLET PROFILE IS SHOWN FOR ILLUSTRATIVE PURPOSES ONLY
- (XX.XX) = MILLIMETERS
- * = DIMENSIONS ARE TO INTERSECTION OF LINES
- ⊗ = HEADSPACE DIMENSION

DO NOT SCALE FROM DRAWING

NOTICE: This drawing is subject to change.
 Revisions, if applicable, are available at www.saami.org.

ISSUED: 05/29/1979 **284 WINCHESTER [284 WIN]** REVISED: 05/05/2022

CARTRIDGE

UNLESS OTHERWISE NOTED
 BODY DIA. -.008 (0.20)

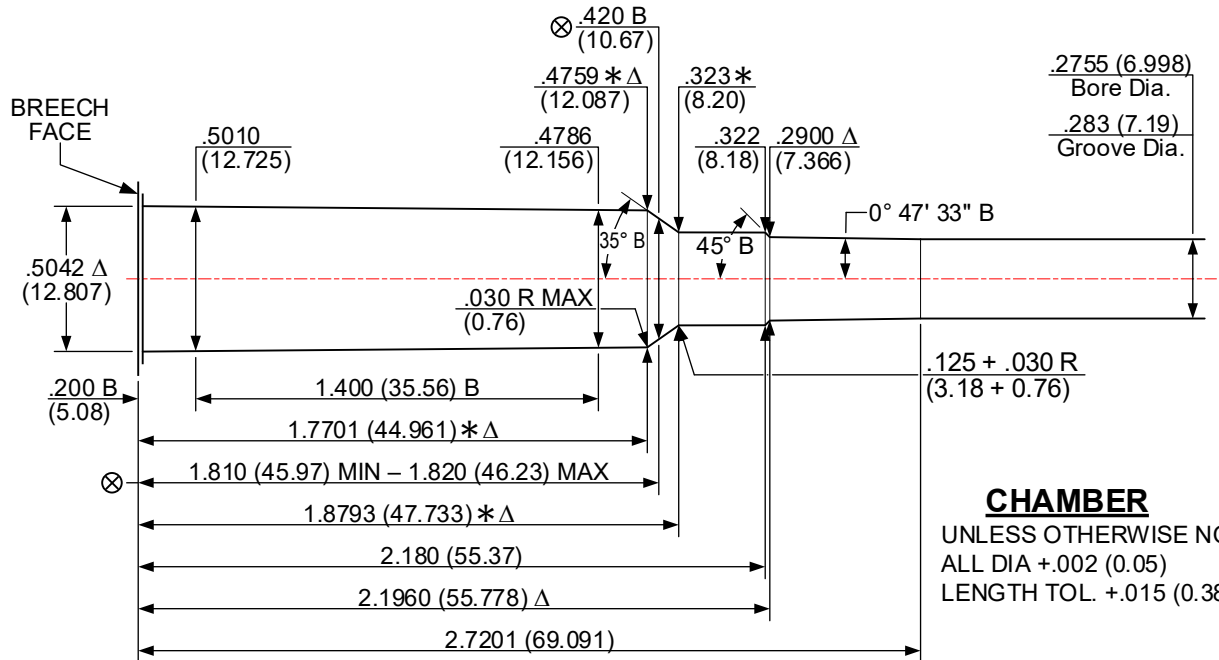
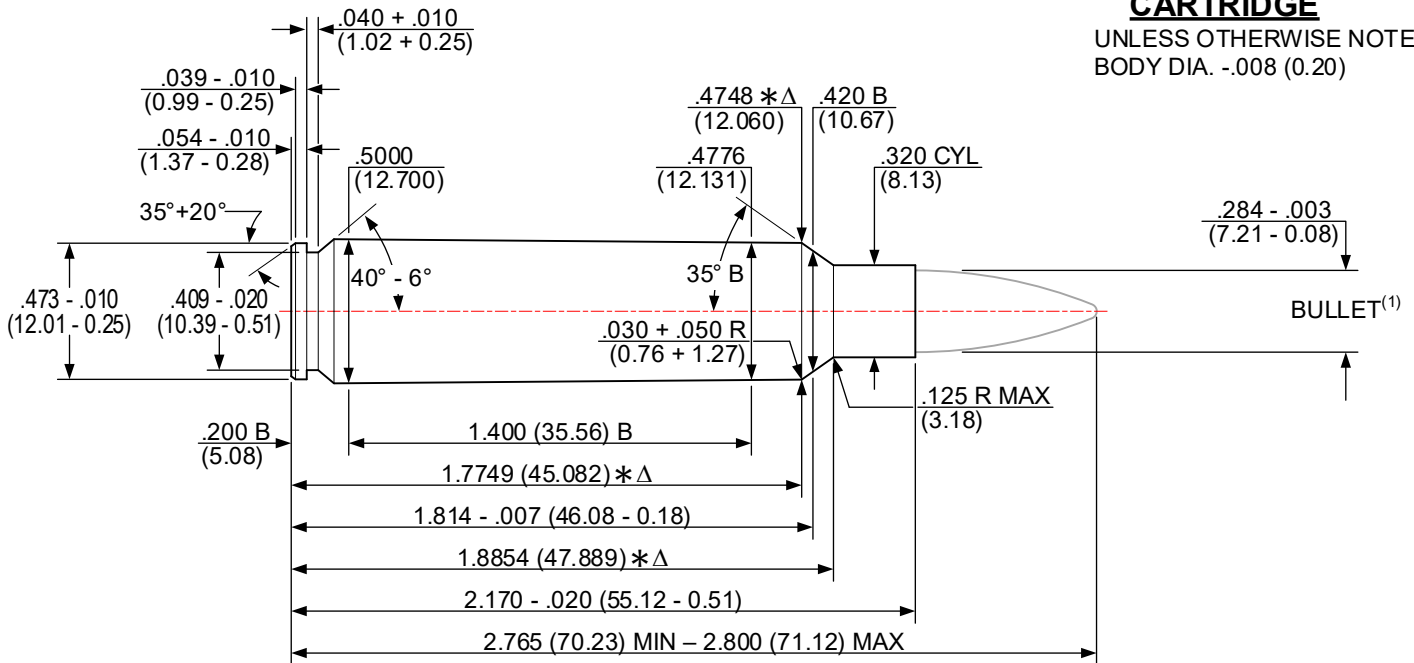

CHAMBER

UNLESS OTHERWISE NOTED
 ALL DIA +.002 (0.05)
 LENGTH TOL. +.015 (0.38)

Δ 6 GROOVES TWIST: 10.00 (254.0) RH OPTIONAL
 Δ .110+.002 (2.79+0.05) WIDE MINIMUM BORE & GROOVE AREA: .0621 in² (40.064 mm²)

NOTES:

- B = BASIC (XX.XX) = MILLIMETERS ⊗ = HEADSPACE DIMENSION
- Δ = REFERENCE DIMENSION * = DIMENSIONS ARE TO INTERSECTION OF LINES
- ALL CALCULATIONS APPLY AT MAXIMUM MATERIAL CONDITION (MMC)
- (1) – BULLET PROFILE IS SHOWN FOR ILLUSTRATIVE PURPOSES ONLY

DO NOT SCALE FROM DRAWING

NOTICE: This drawing is subject to change.
 Revisions, if applicable, are available at www.saami.org.

ISSUED: 05/29/1979 **30 CARBINE [30 CARB]** REVISED: 05/16/2022

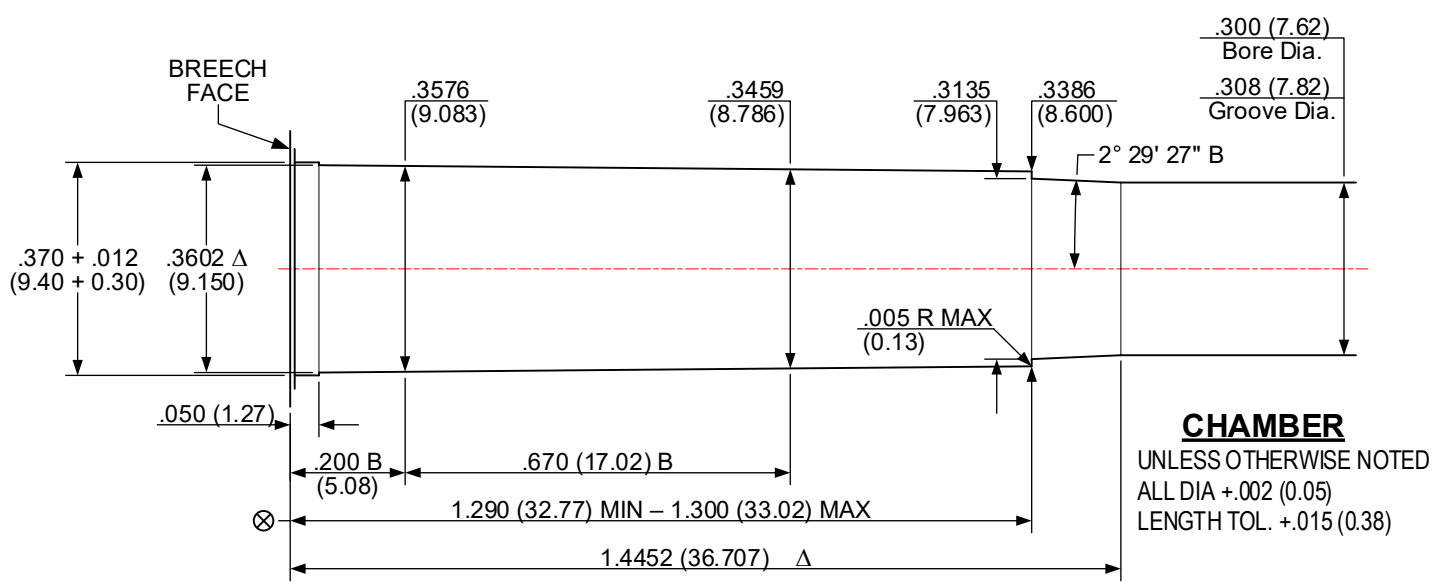
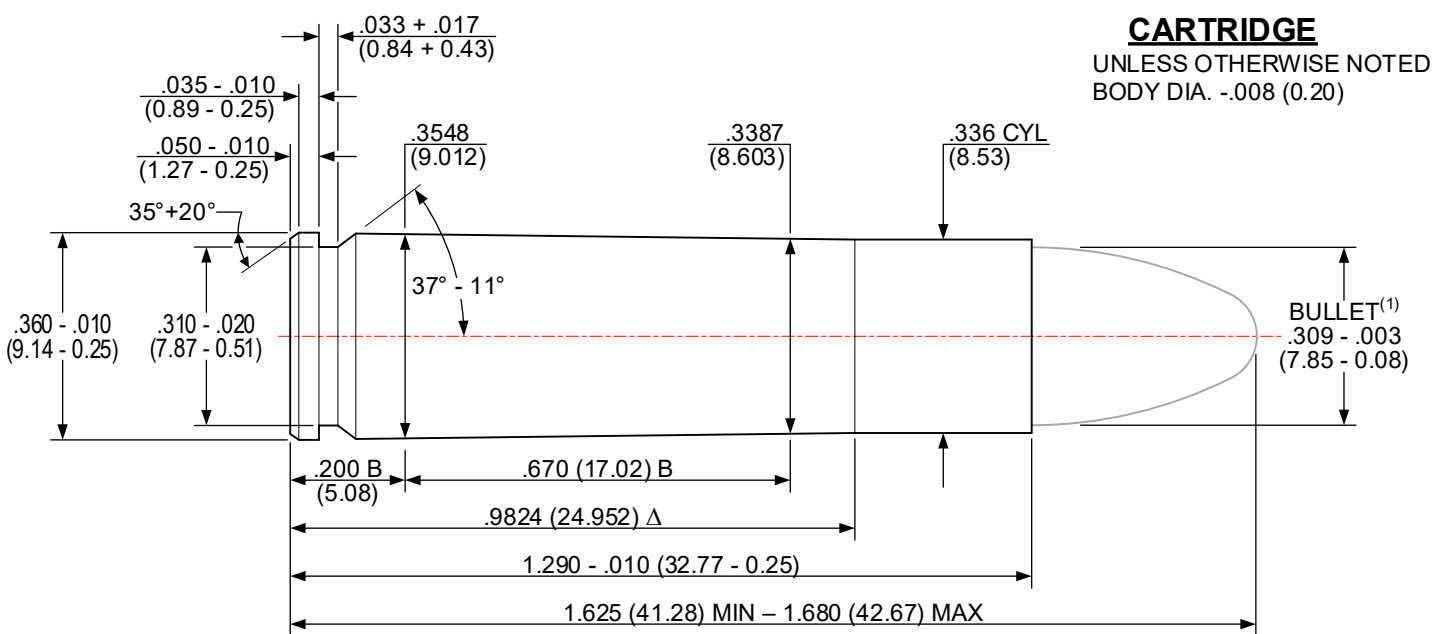

Δ 4 GROOVES
 $\Delta .167 \pm .002$ (4.24 + 0.05) WIDE

TWIST: 20.00 (508.0) R.H. OPTIONAL
 MINIMUM BORE & GROOVE AREA: .0735 in² (47.419 mm²)

NOTES:

B = BASIC (XX.XX) = MILLIMETERS \otimes = HEAD SPACE DIMENSION
 Δ = REFERENCE DIMENSION * = DIMENSIONS ARE TO INTERSECTION OF LINES

ALL CALCULATIONS APPLY AT MAXIMUM MATERIAL CONDITION (MMC)
 (1) – BULLET PROFILE IS SHOWN FOR ILLUSTRATIVE PURPOSES ONLY

DO NOT SCALE FROM DRAWING

NOTICE: This drawing is subject to change.
 Revisions, if applicable, are available at www.saami.org.

ISSUED: 01/19/2015

30 NOSLER [30 NOSLER]

REVISED: 05/18/2022

CARTRIDGE

UNLESS OTHERWISE NOTED
 BODY DIA. -.008 (0.20)

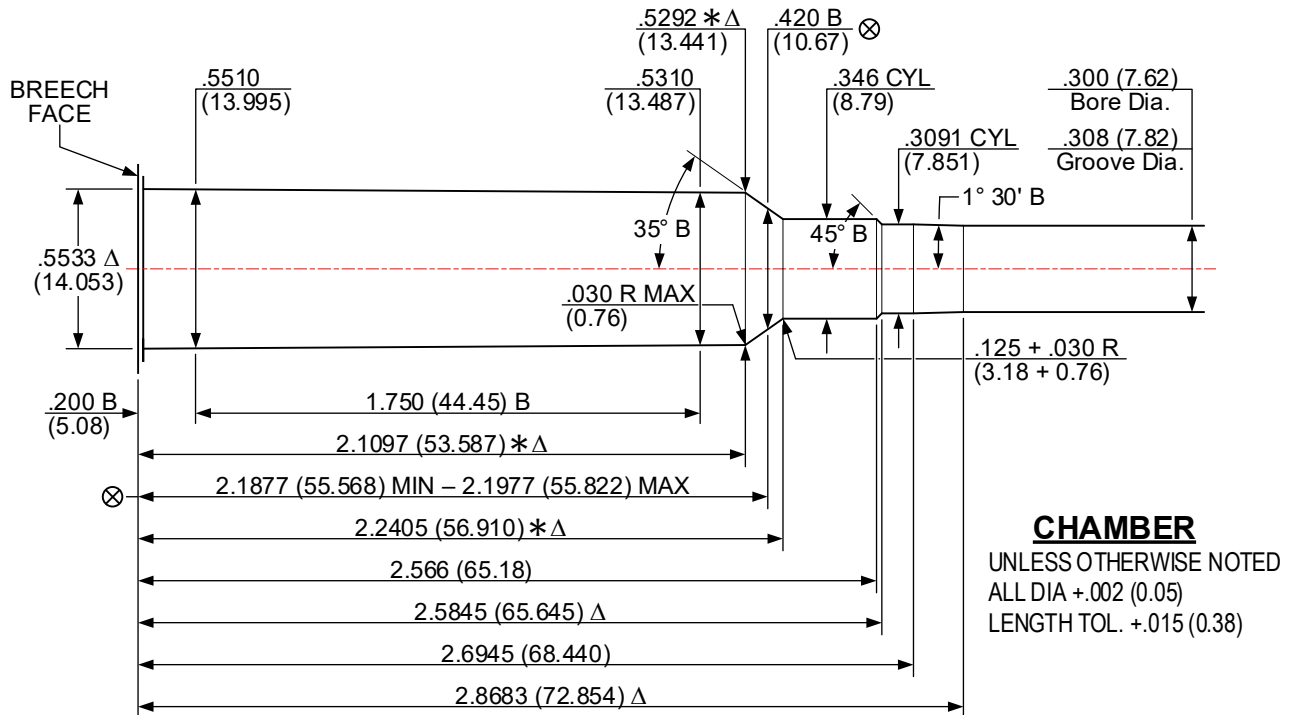
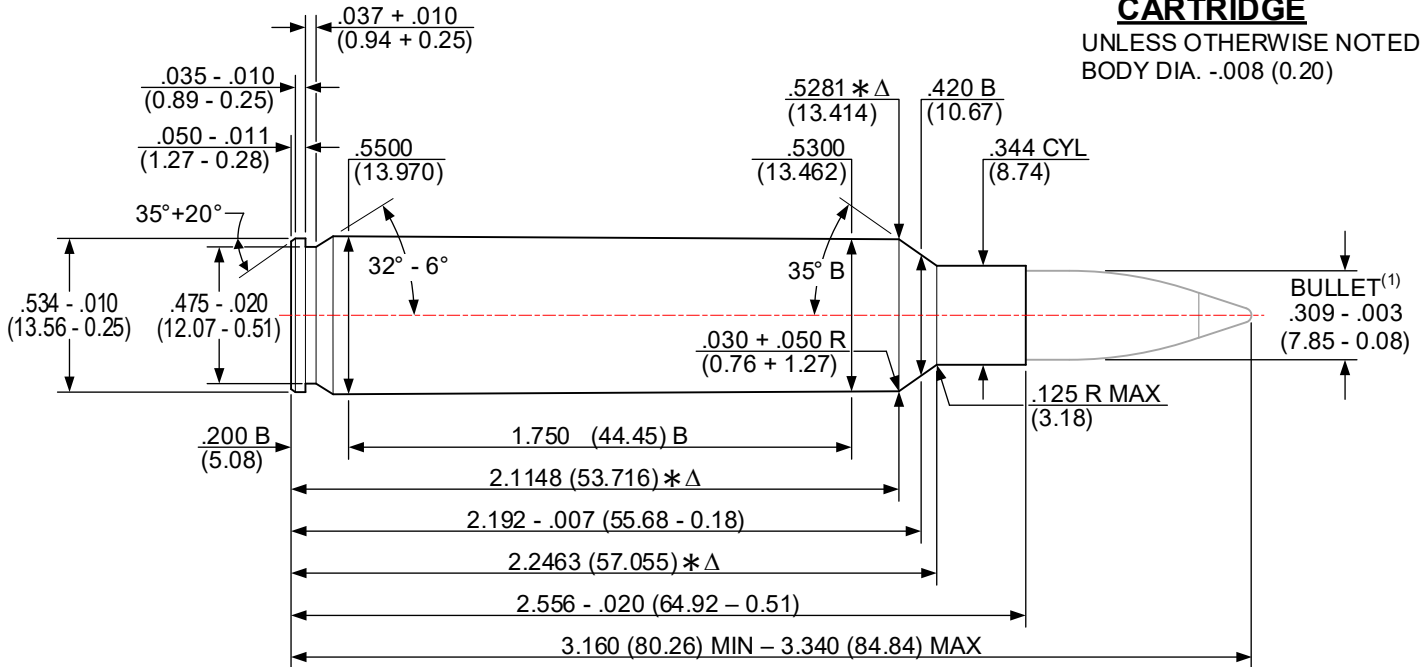

CHAMBER

UNLESS OTHERWISE NOTED
 ALL DIA +.002 (0.05)
 LENGTH TOL. +.015 (0.38)

Δ 6 GROOVES
 Δ .110+.002 (2.79+0.05) WIDE

TWIST: 10.00 (254.0) R.H. OPTIONAL
 MINIMUM BORE & GROOVE AREA: .0733 in² (47.290 mm²)

NOTES:

- B = BASIC
- Δ = REFERENCE DIMENSION
- ALL CALCULATIONS APPLY AT MAXIMUM MATERIAL CONDITION (MMC)
- (1) – BULLET PROFILE IS SHOWN FOR ILLUSTRATIVE PURPOSES ONLY
- (XX.XX) = MILLIMETERS
- * = DIMENSIONS ARE TO INTERSECTION OF LINES
- ⊗ = HEADSPACE DIMENSION

DO NOT SCALE FROM DRAWING

ISSUED: 06/17/2009 **30 REMINGTON AR [30 REM AR]** REVISED: 05/18/2022

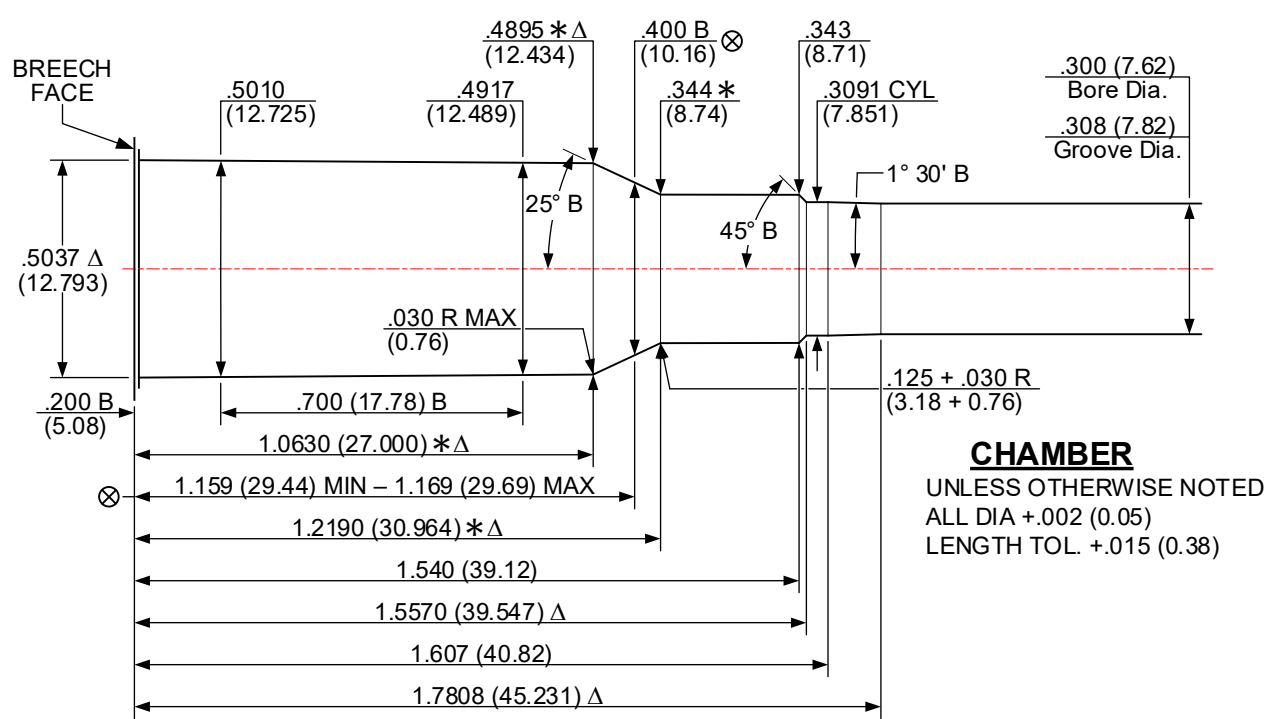
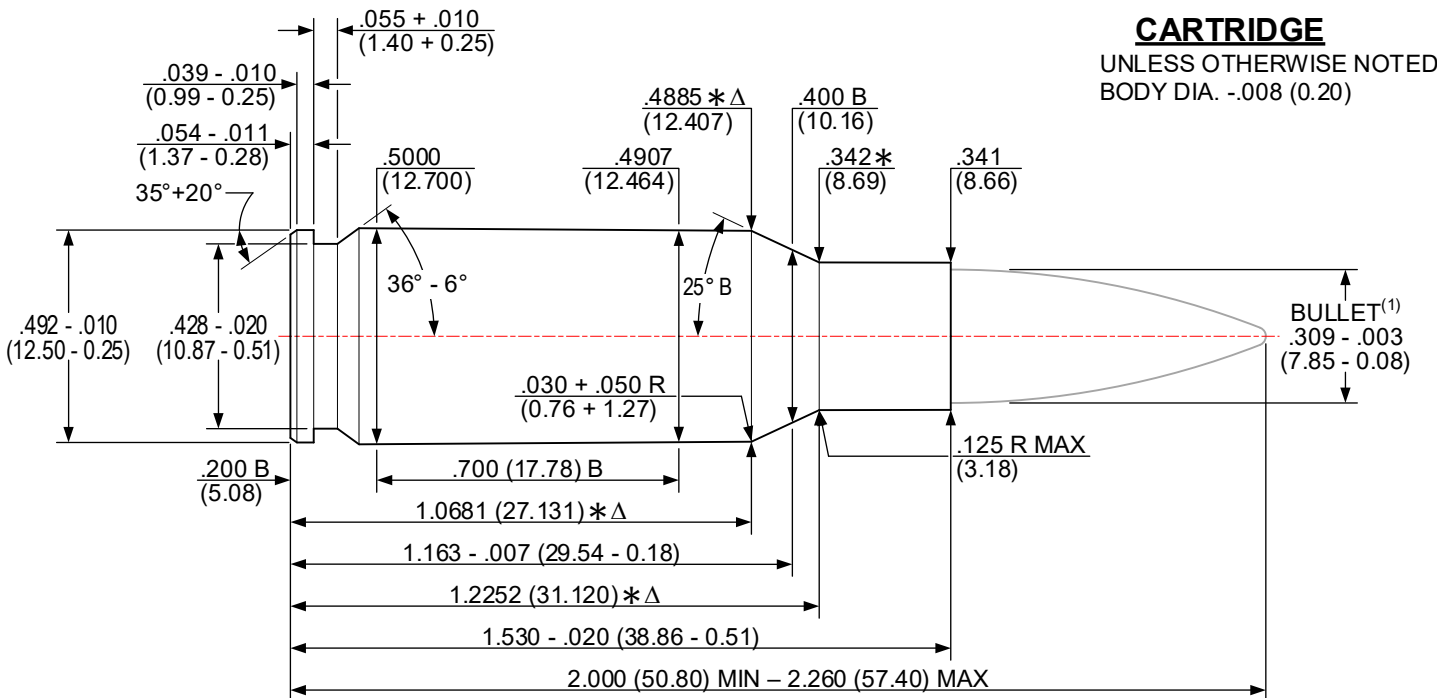

Δ 4 GROOVES TWIST: 10.00 (254.0) R.H. OPTIONAL
 Δ .176+.002 (4.47+0.05) WIDE MINIMUM BORE & GROOVE AREA: .0736 in² (47.483 mm²)

NOTES:
 B = BASIC (XX.XX) = MILLIMETERS ⊗ = HEADSPACE DIMENSION
 Δ = REFERENCE DIMENSION * = DIMENSIONS ARE TO INTERSECTION OF LINES
 ALL CALCULATIONS APPLY AT MAXIMUM MATERIAL CONDITION (MMC)
 (1) – BULLET PROFILE IS SHOWN FOR ILLUSTRATIVE PURPOSES ONLY

DO NOT SCALE FROM DRAWING

NOTICE: This drawing is subject to change.
 Revisions, if applicable, are available at www.saami.org.

ISSUED: 02/01/2008

30 THOMPSON CENTER [30 TC]

REVISED: 05/19/2022

CARTRIDGE

UNLESS OTHERWISE NOTED
 BODY DIA. -.008 (0.20)

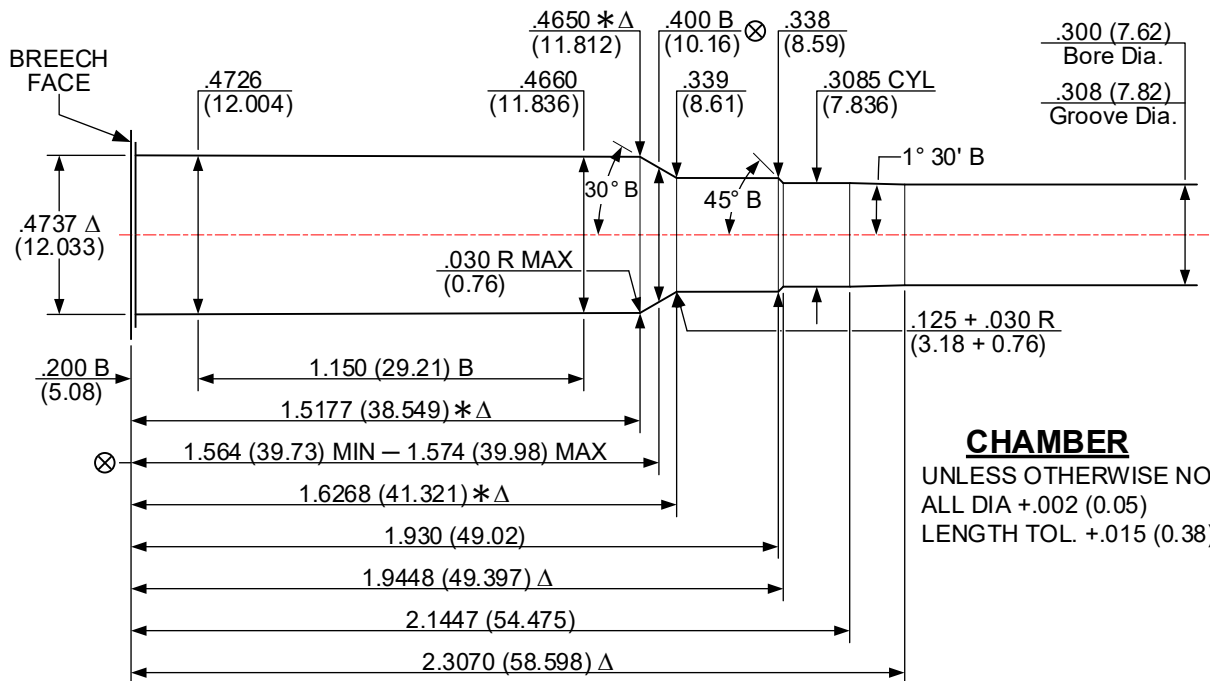
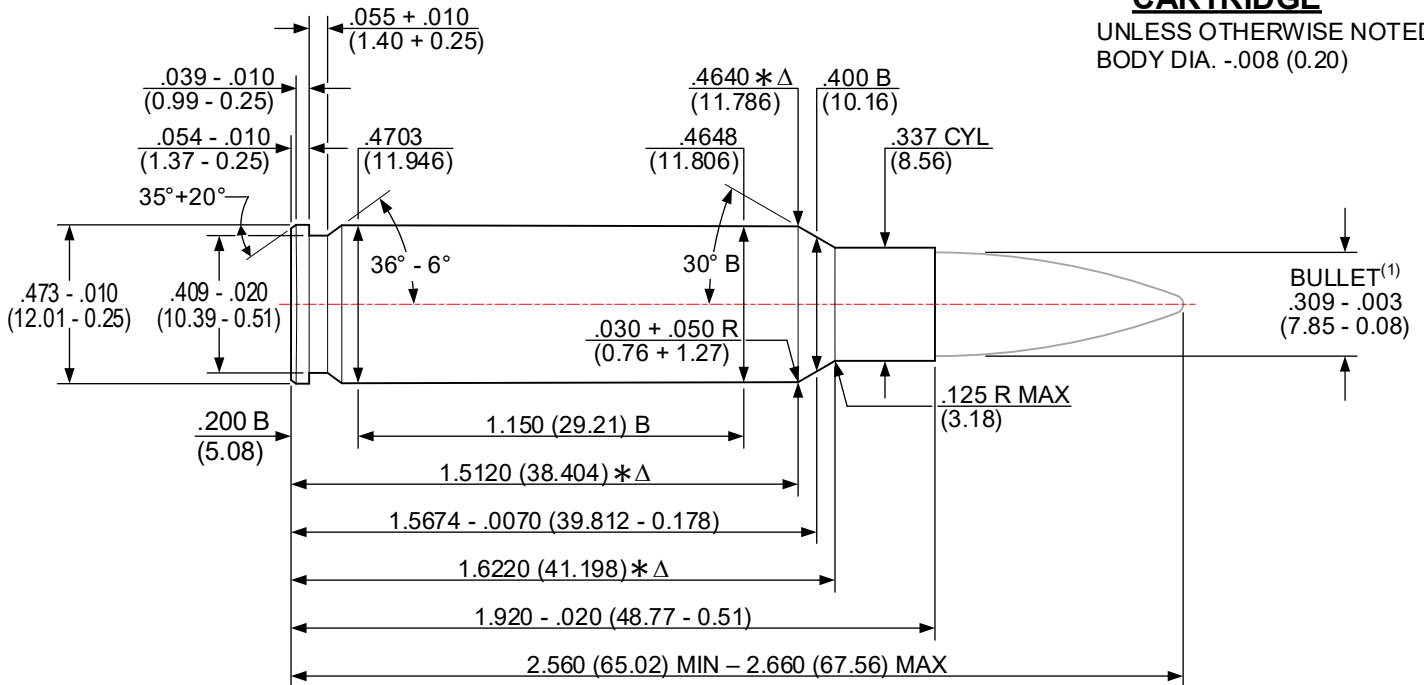

CHAMBER

UNLESS OTHERWISE NOTED
 ALL DIA +.002 (0.05)
 LENGTH TOL. +.015 (0.38)

Δ 4 GROOVES TWIST: 12.00 (304.8) R.H. OPTIONAL
 Δ .176+.002 (4.47+0.05) WIDE MINIMUM BORE & GROOVE AREA: .0736 in² (47.483 mm²)

NOTES:

- B = BASIC
- Δ = REFERENCE DIMENSION
- ALL CALCULATIONS APPLY AT MAXIMUM MATERIAL CONDITION (MMC)
- (1) – BULLET PROFILE IS SHOWN FOR ILLUSTRATIVE PURPOSES ONLY
- (XX.XX) = MILLIMETERS
- * = DIMENSIONS ARE TO INTERSECTION OF LINES
- ⊗ = HEAD SPACE DIMENSION

DO NOT SCALE FROM DRAWING

NOTICE: This drawing is subject to change.
 Revisions, if applicable, are available at www.saami.org.

ISSUED: 05/29/1979 **30-06 SPRINGFIELD [30-06 SPRG]** REVISED: 05/19/2022

CARTRIDGE

UNLESS OTHERWISE NOTED
 BODY DIA. -.008 (0.20)

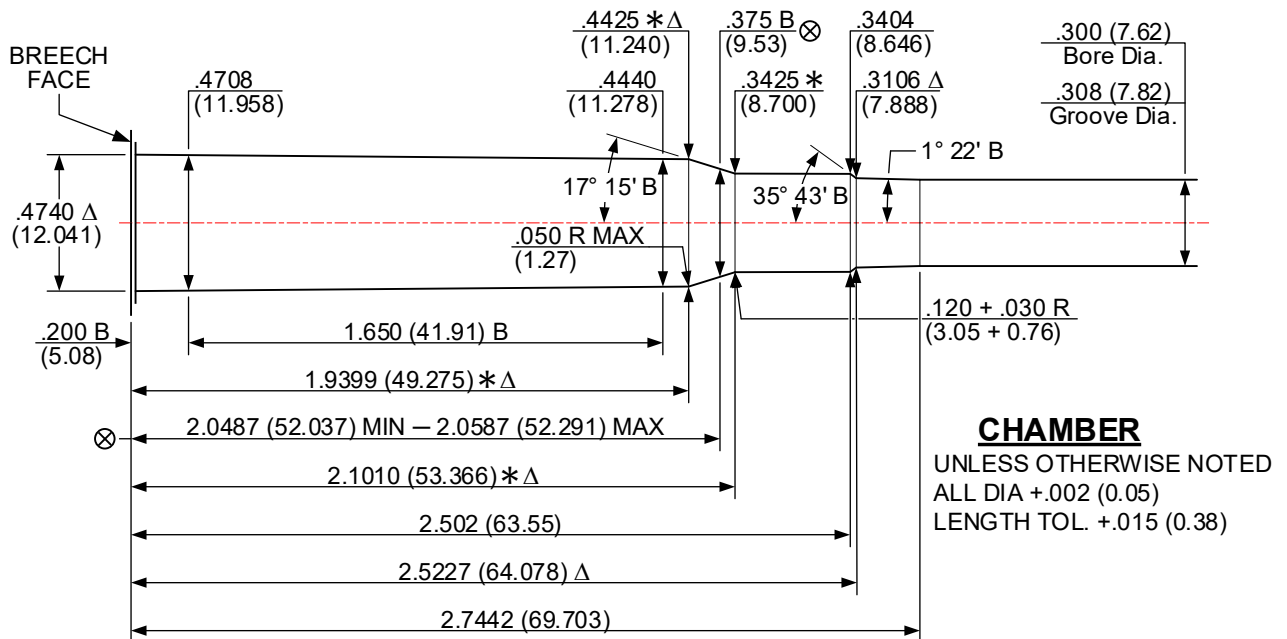
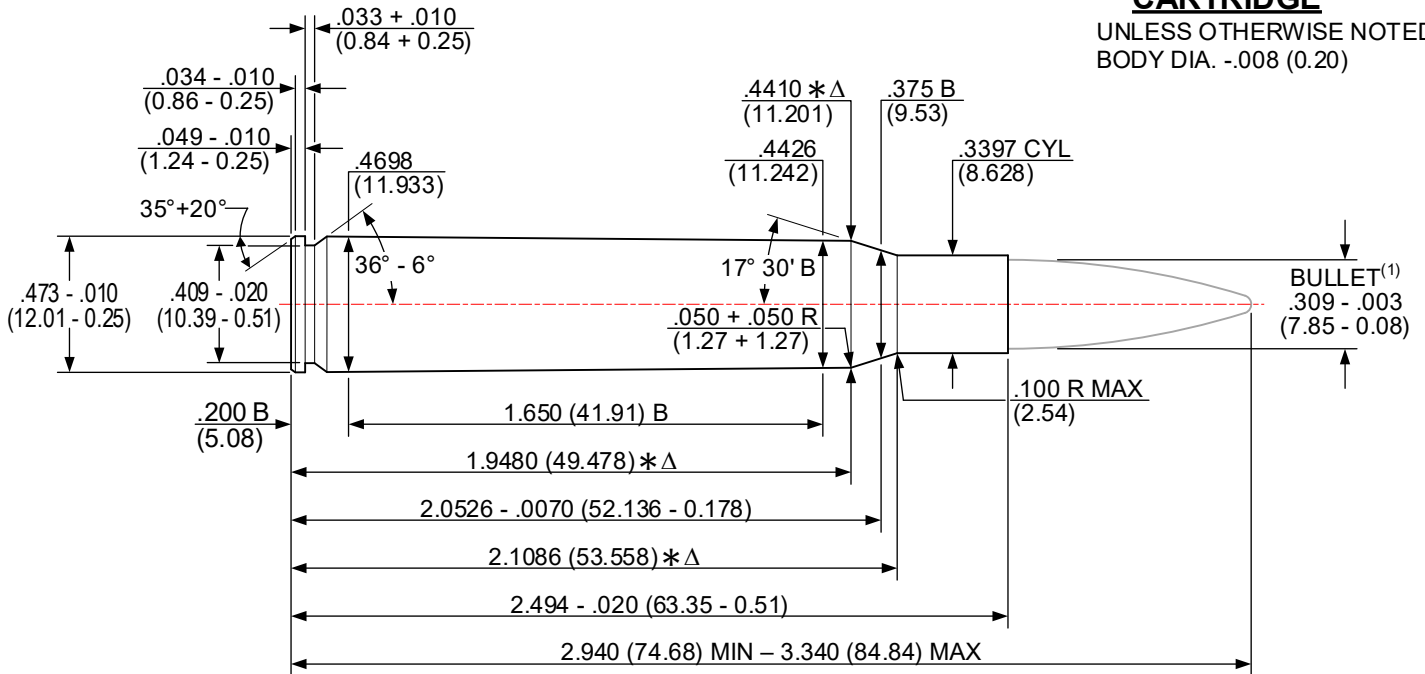

CHAMBER

UNLESS OTHERWISE NOTED
 ALL DIA +.002 (0.05)
 LENGTH TOL. +.015 (0.38)

Δ 4 GROOVES
 Δ .1767+.0020 (4.488+0.051) WIDE

TWIST: 10.00 (254.0) R.H. OPTIONAL
 MINIMUM BORE & GROOVE AREA: .0737 in² (47.548 mm²)

NOTES:

- B = BASIC
- Δ = REFERENCE DIMENSION
- ALL CALCULATIONS APPLY AT MAXIMUM MATERIAL CONDITION (MMC)
- (1) – BULLET PROFILE IS SHOWN FOR ILLUSTRATIVE PURPOSES ONLY
- (XX.XX) = MILLIMETERS
- * = DIMENSIONS ARE TO INTERSECTION OF LINES
- ⊗ = HEAD SPACE DIMENSION

DO NOT SCALE FROM DRAWING

ISSUED: 05/29/1979 **30-30 WINCHESTER [30-30 WIN]** REVISED: 02/10/2023

CARTRIDGE

UNLESS OTHERWISE NOTED
 BODY DIA. -.008 (0.20)

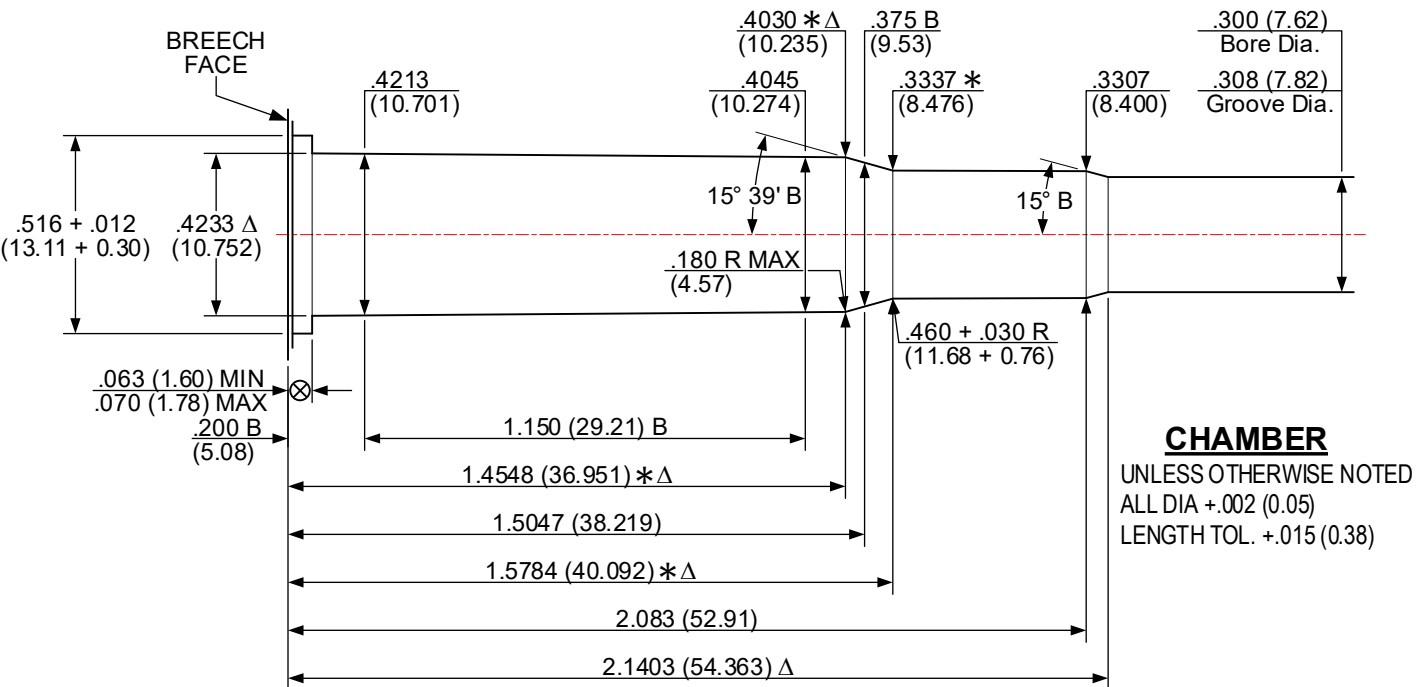
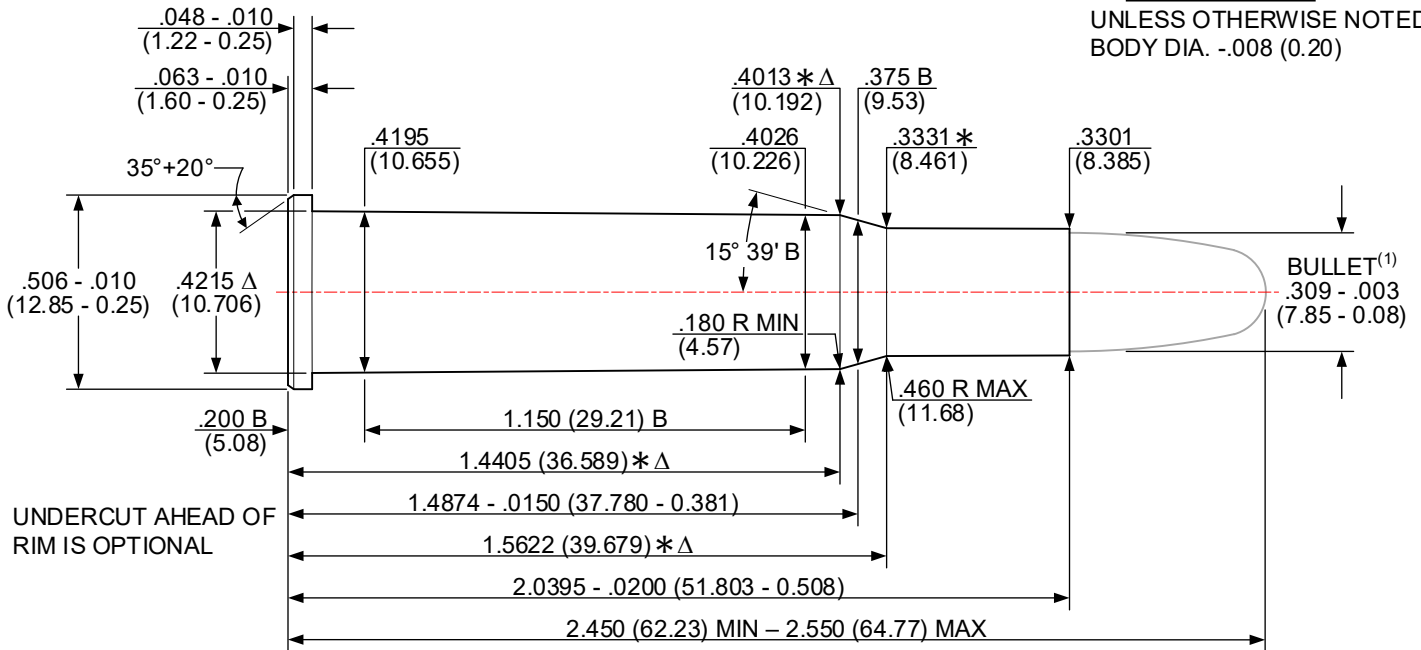

Δ 6 GROOVES

$\Delta .0942 + .0020 (2.393 + 0.051)$ WIDE

TWIST: 12.00 (304.8) R.H. OPTIONAL

MINIMUM BORE & GROOVE AREA: $.0729 \text{ in}^2 (47.032 \text{ mm}^2)$

NOTES:

B = BASIC

(XX.XX) = MILLIMETERS

\otimes = HEAD SPACE DIMENSION

Δ = REFERENCE DIMENSION

* = DIMENSIONS ARE TO INTERSECTION OF LINES

ALL CALCULATIONS APPLY AT MAXIMUM MATERIAL CONDITION (MMC)

(1) – BULLET PROFILE IS SHOWN FOR ILLUSTRATIVE PURPOSES ONLY

DO NOT SCALE FROM DRAWING

ISSUED: 05/29/1979 **30-40 KRAG [30-40 KRAG]** **REVISED: 02/10/2023**

CARTRIDGE
 UNLESS OTHERWISE NOTED
 BODY DIA. -.008 (0.20)

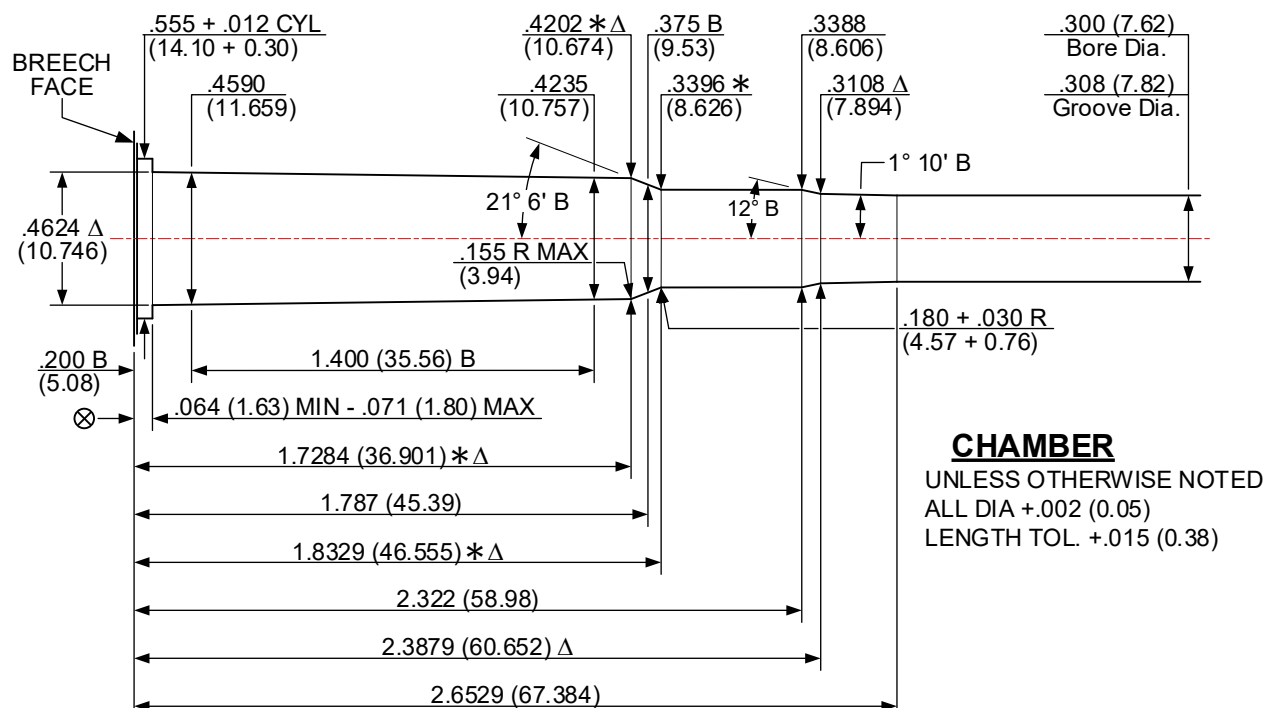
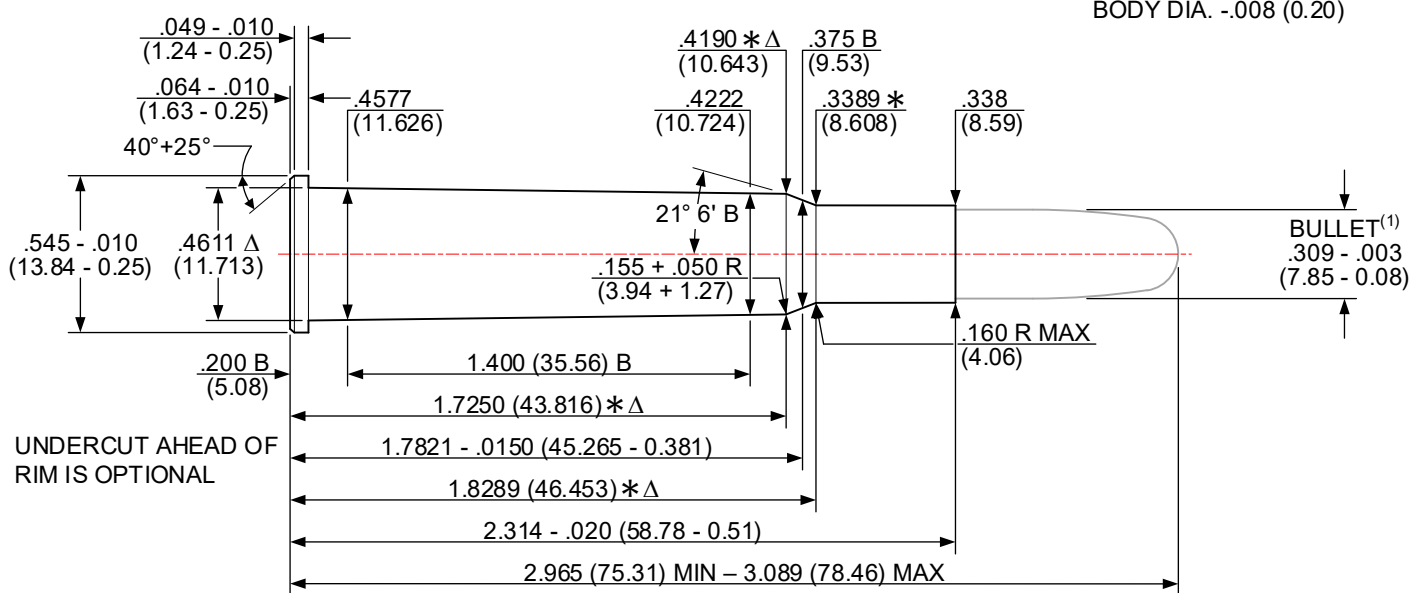

Δ 6 GROOVES TWIST: 10.00 (254.0) R.H. OPTIONAL
 Δ .094+.0020 (2.39+0.05) WIDE MINIMUM BORE & GROOVE AREA: .0729 in² (47.032 mm²)

NOTES:
 B = BASIC (XX.XX) = MILLIMETERS ⊗ = HEAD SPACE DIMENSION
 Δ = REFERENCE DIMENSION * = DIMENSIONS ARE TO INTERSECTION OF LINES
 ALL CALCULATIONS APPLY AT MAXIMUM MATERIAL CONDITION (MMC)
 (1) – BULLET PROFILE IS SHOWN FOR ILLUSTRATIVE PURPOSES ONLY

DO NOT SCALE FROM DRAWING

NOTICE: This drawing is subject to change.
 Revisions, if applicable, are available at www.saami.org.

ISSUED: 01/17/2011 **300 AAC BLACKOUT [300 BLK]** **REVISED: 05/20/2022**

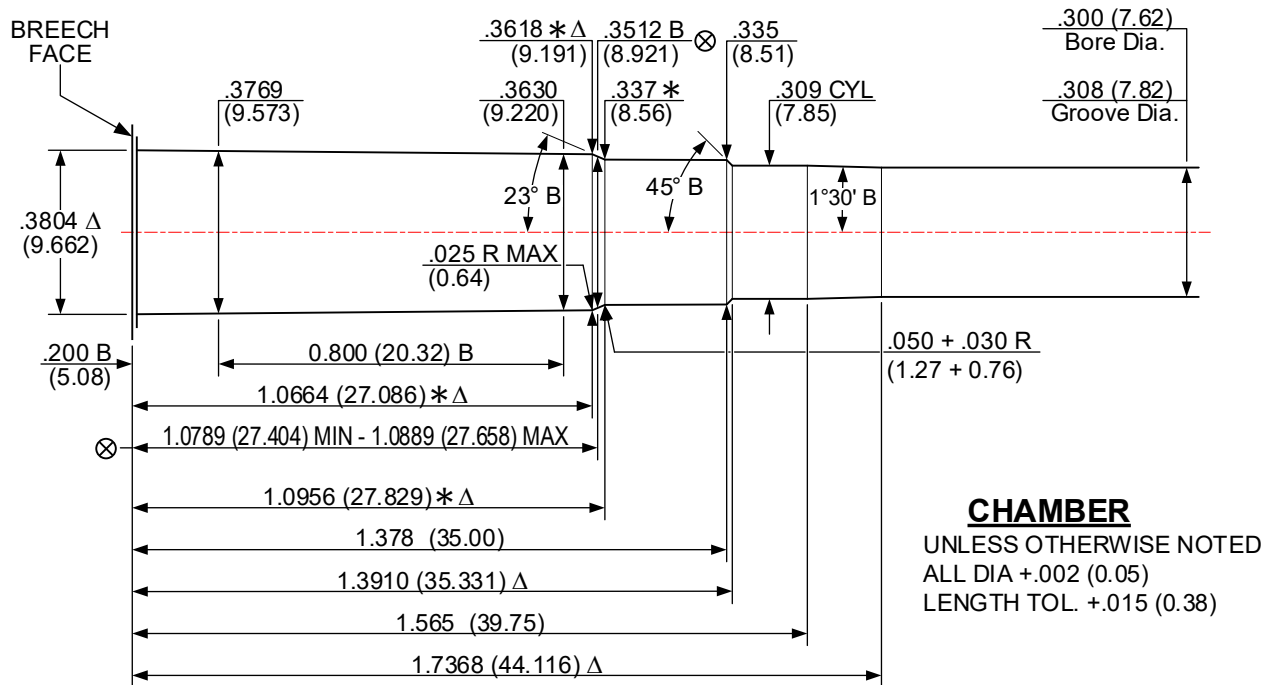
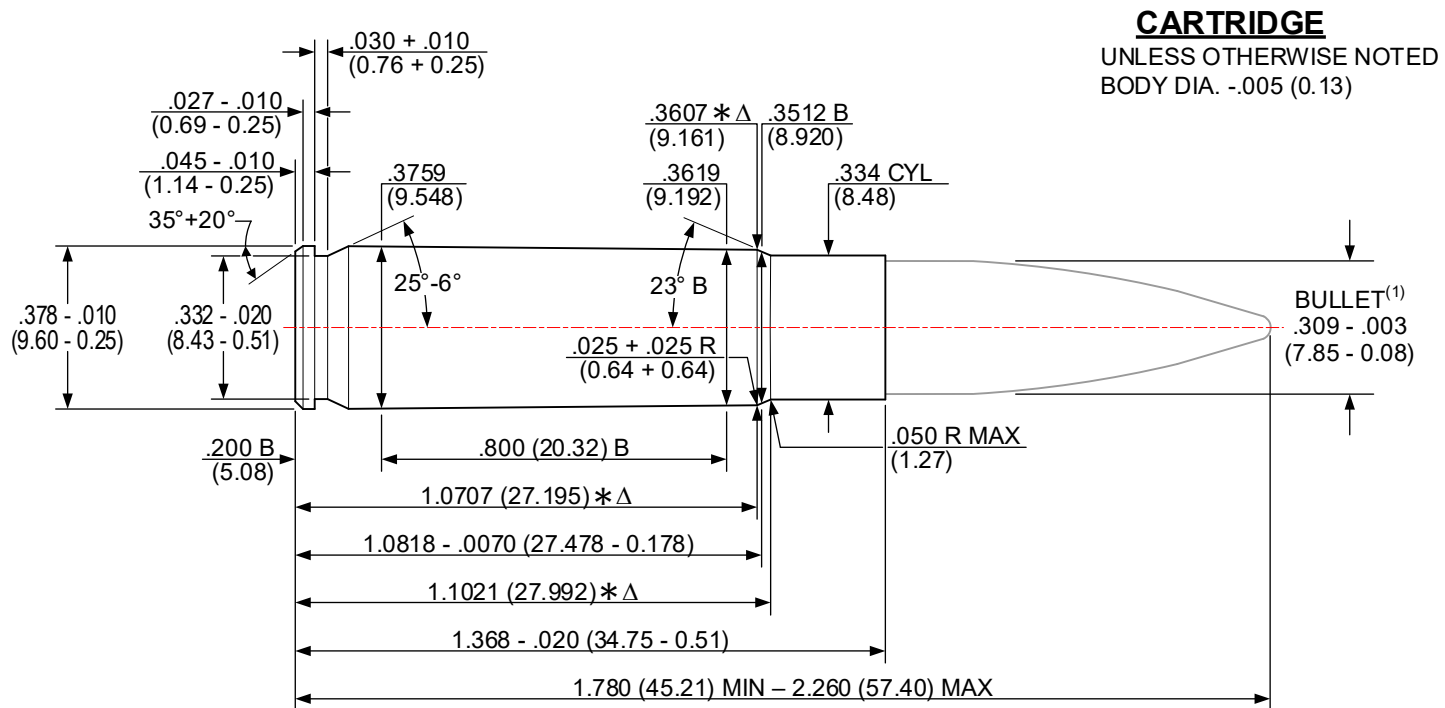

Δ 5 GROOVES TWIST: 8.00 (203.2) R.H. OPTIONAL
 Δ .146+.002 (3.71+0.05) WIDE MINIMUM BORE & GROOVE AREA: .0737 inch² (47.548 mm²)

NOTES:
 B = BASIC (XX.XX) = MILLIMETERS ⊗ = HEADSPACE DIMENSION
 Δ = REFERENCE DIMENSION * = DIMENSIONS ARE TO INTERSECTION OF LINES
 ALL CALCULATIONS APPLY AT MAXIMUM MATERIAL CONDITION (MMC)
 (1) – BULLET PROFILE IS SHOWN FOR ILLUSTRATIVE PURPOSES ONLY

DO NOT SCALE FROM DRAWING

NOTICE: This drawing is subject to change.
 Revisions, if applicable, are available at www.saami.org.

ISSUED: 01/20/2020 **300 HAM'R [300 HAMR]** REVISED: 06/06/2023

CARTRIDGE

UNLESS OTHERWISE NOTED
 BODY DIA. -.008 (0.20)

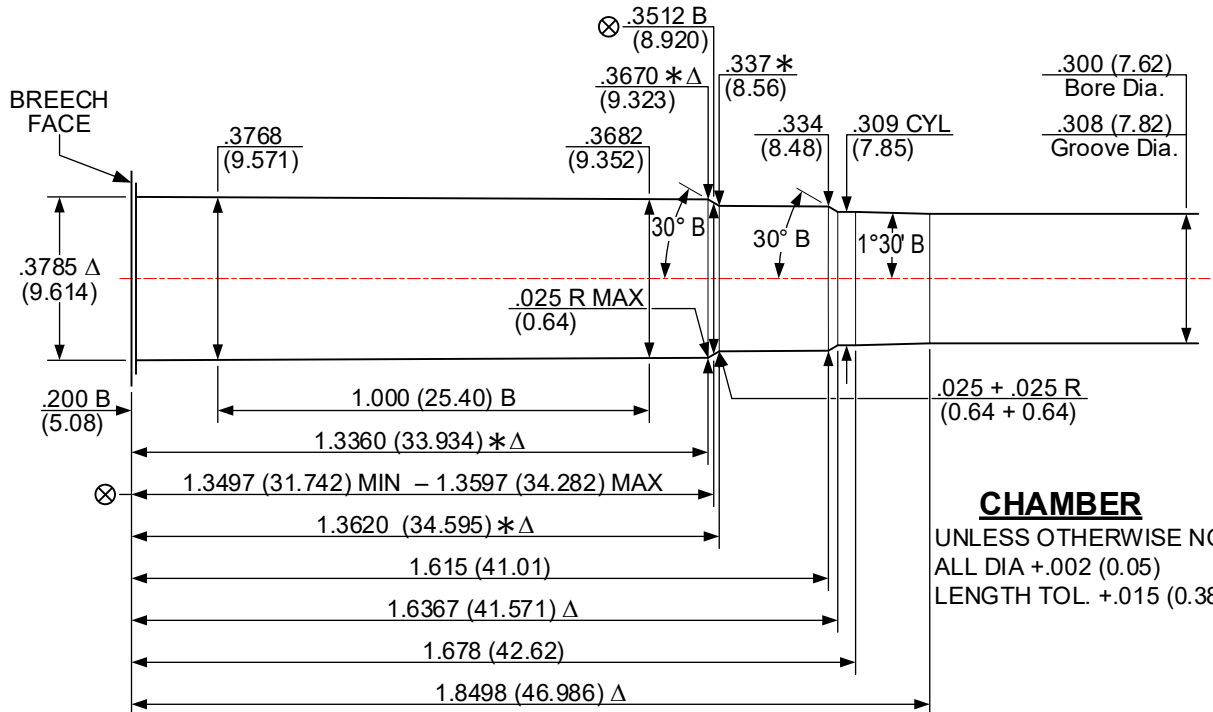
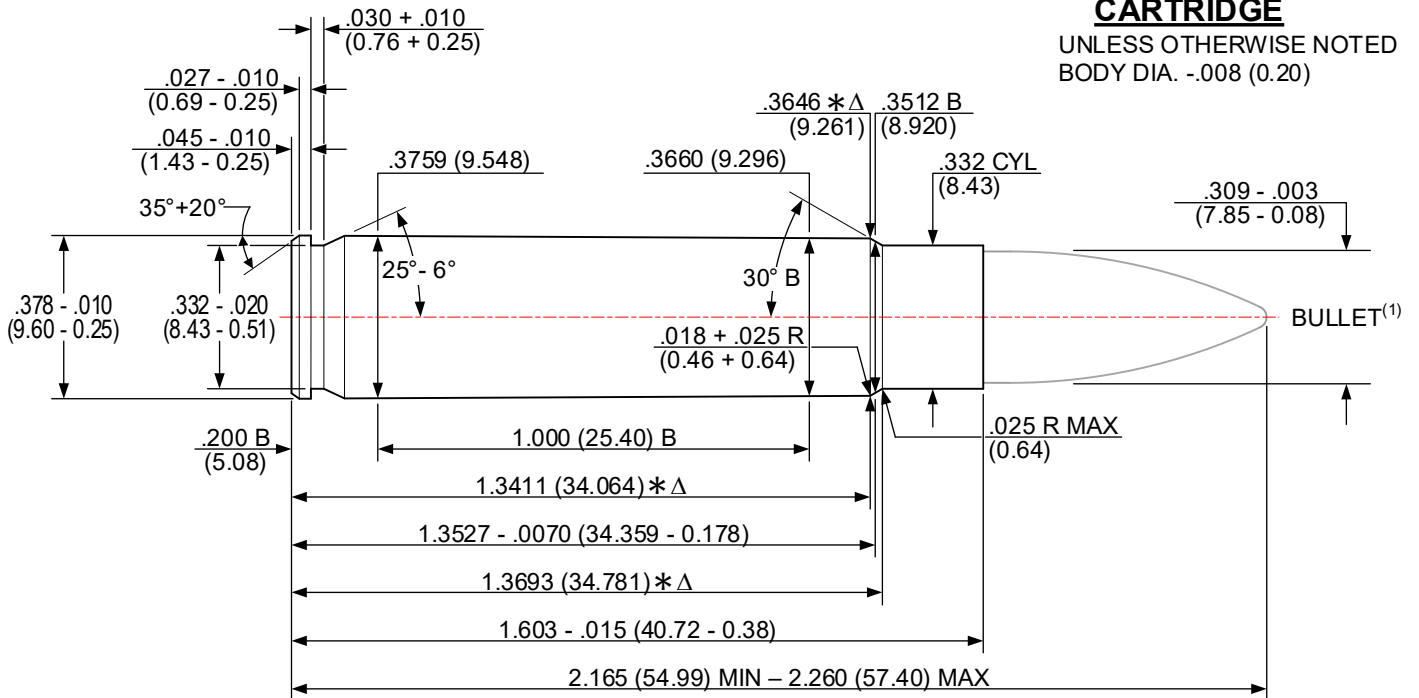

CHAMBER

UNLESS OTHERWISE NOTED
 ALL DIA +.002 (0.05)
 LENGTH TOL. +.015 (0.38)

Δ 4 GROOVES

Δ .176 + .002 (4.47 + 0.05) WIDE

TWIST: 12.00 (304.8) R.H. OPTIONAL

MINIMUM BORE & GROOVE AREA: .0736 inch² (47.483 mm²)

NOTES:

B = BASIC

(XX.XX) = MILLIMETERS

⊗ = HEADSPACE DIMENSION

Δ = REFERENCE DIMENSION

* = DIMENSIONS ARE TO INTERSECTION OF LINES

ALL CALCULATIONS APPLY AT MAXIMUM MATERIAL CONDITION (MMC)

(1) – BULLET PROFILE IS SHOWN FOR ILLUSTRATIVE PURPOSES ONLY

DO NOT SCALE FROM DRAWING

NOTICE: This drawing is subject to change.
 Revisions, if applicable, are available at www.saami.org.

ISSUED: 04/21/1980 **300 HOLLAND & HOLLAND MAGNUM [300 H&H MAG]** REVISED: 05/20/2022

CARTRIDGE

UNLESS OTHERWISE NOTED
 BODY DIA. -.008 (0.20)

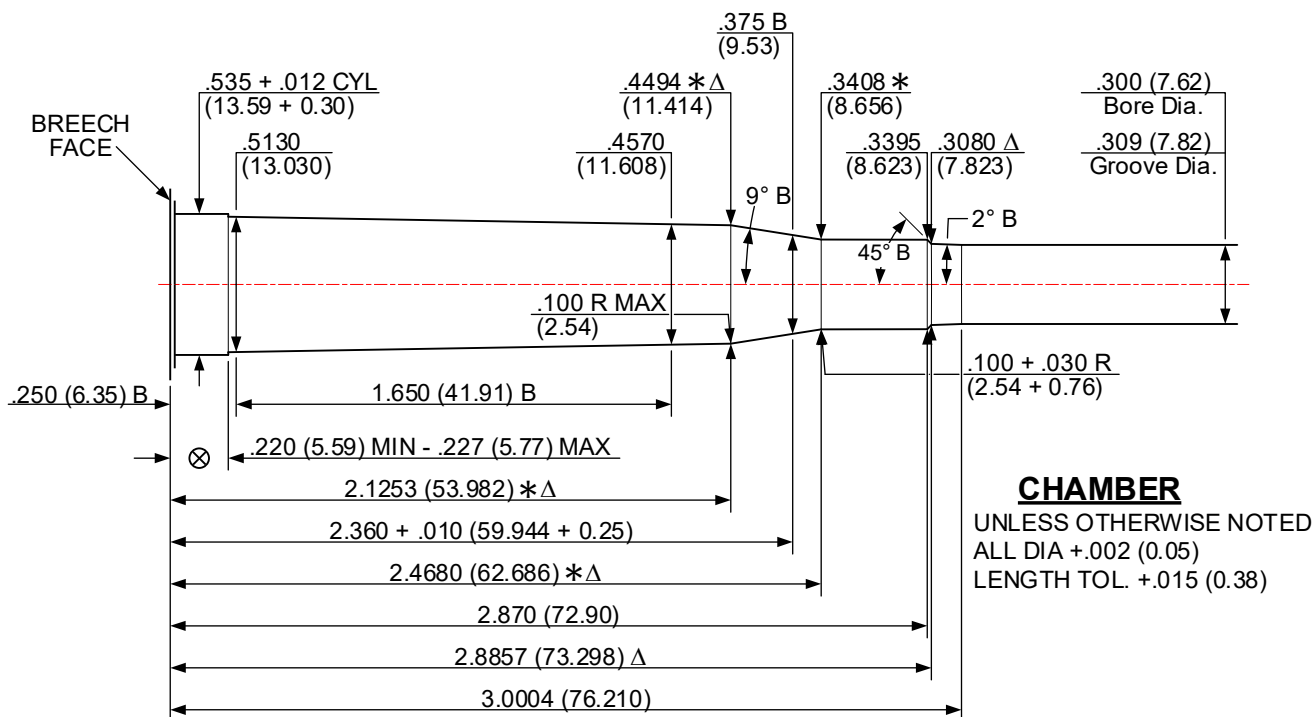
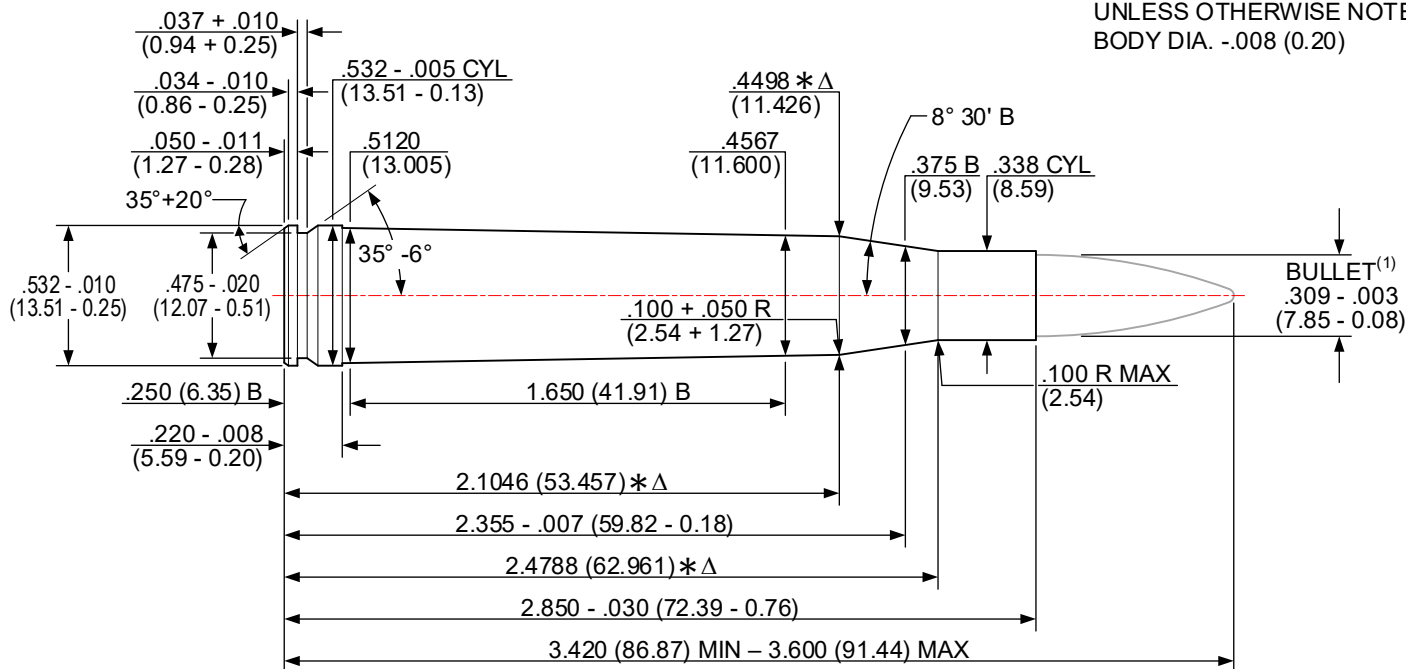

CHAMBER

UNLESS OTHERWISE NOTED
 ALL DIA +.002 (0.05)
 LENGTH TOL. +.015 (0.38)

Δ 4 GROOVES TWIST: 10.00 (254.0) R.H. OPTIONAL
 Δ .176+.002 (4.47+0.05) WIDE MINIMUM BORE & GROOVE AREA: .0736 in² (47.483 mm²)

NOTES:

- B = BASIC
- Δ = REFERENCE DIMENSION
- ALL CALCULATIONS APPLY AT MAXIMUM MATERIAL CONDITION (MMC)
- (1) – BULLET PROFILE IS SHOWN FOR ILLUSTRATIVE PURPOSES ONLY
- (XX.XX) = MILLIMETERS
- * = DIMENSIONS ARE TO INTERSECTION OF LINES
- ⊗ = HEADSPACE DIMENSION

DO NOT SCALE FROM DRAWING

ISSUED: 09/23/2020 **300 NORMA MAGNUM [300 NM]** REVISED: 10/11/2024

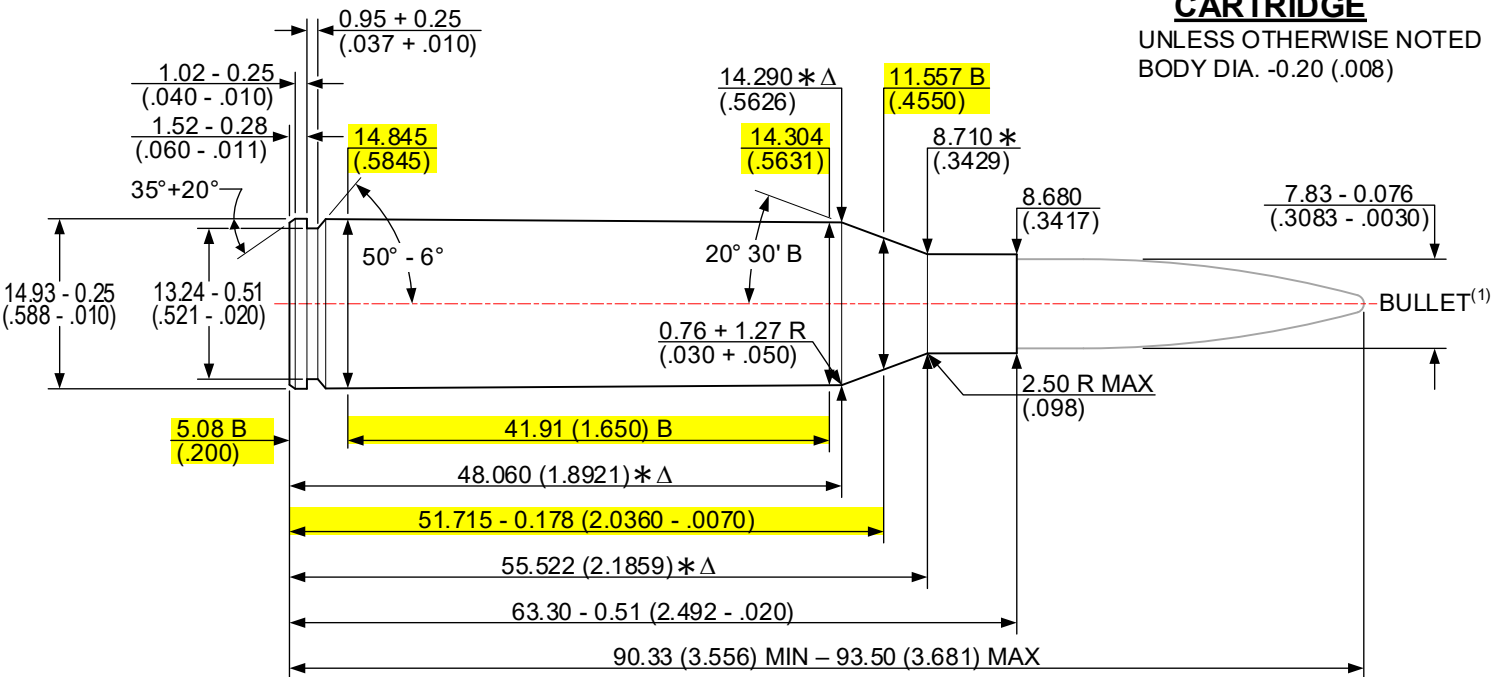

HIGHLIGHTED DIMENSIONS HAVE NO CORRESPONDING C.I.P. ANALOG. THE METRIC UNITS FOR THESE ARE THE ORIGINAL VALUES; U.S. CUSTOMARY VALUES ARE CALCULATED AND ROUNDED.

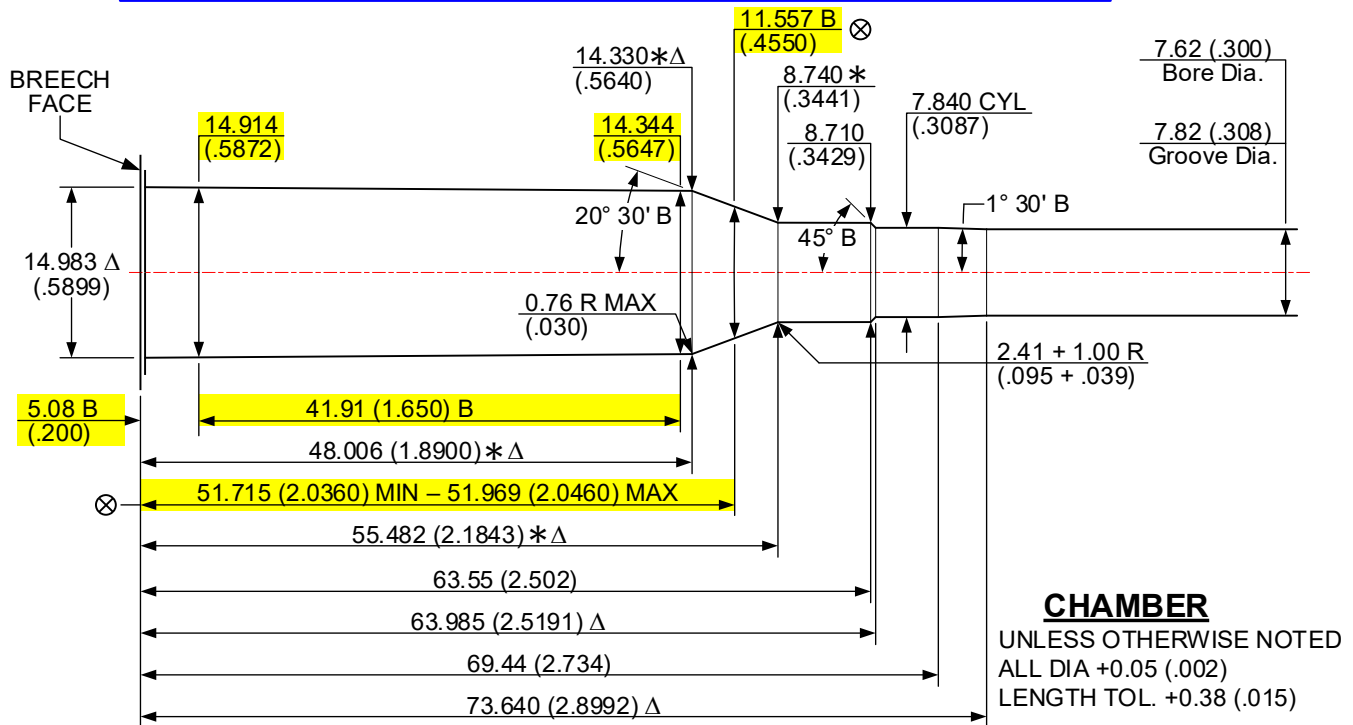

Δ 4 GROOVES TWIST: 229.0 (9.02) R.H. OPTIONAL
 Δ 4.47+0.05 (.176+.002) WIDE MINIMUM BORE & GROOVE AREA: 47.51 mm² (.0736 in²)

NOTES:
 B = BASIC (XX.XX) = INCHES ⊗ = HEADSPACE DIMENSION
 Δ = REFERENCE DIMENSION * = DIMENSIONS ARE TO INTERSECTION OF LINES
 ALL CALCULATIONS APPLY AT MAXIMUM MATERIAL CONDITION (MMC)
 (1) – BULLET PROFILE IS SHOWN FOR ILLUSTRATIVE PURPOSES ONLY

DO NOT SCALE FROM DRAWING

NOTICE: This drawing is subject to change.
 Revisions, if applicable, are available at www.saami.org.

METRIC ORIGIN
 METRIC ORIGIN
 METRIC ORIGIN
 METRIC ORIGIN

ISSUED: 06/13/2018 **300 PRECISION RIFLE CARTRIDGE [300 PRC]** REVISED: 02/17/2022

CARTRIDGE

UNLESS OTHERWISE NOTED
 BODY DIA. -.008 (0.20)

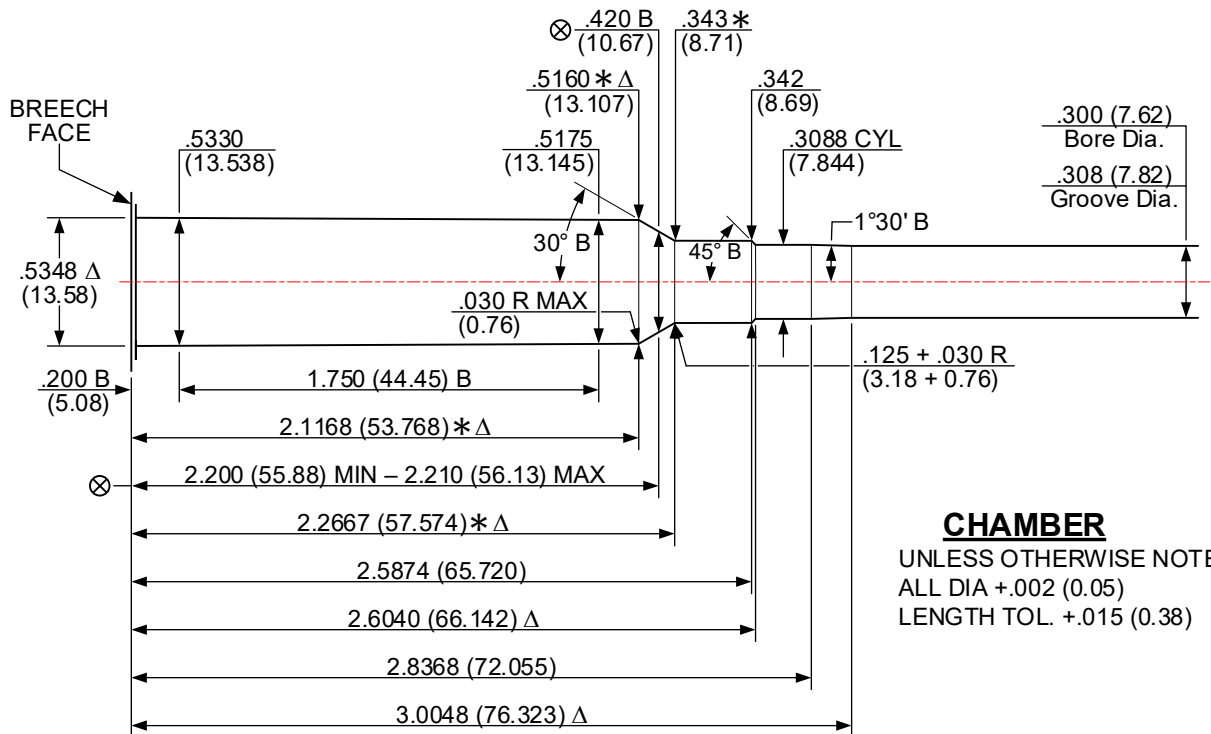
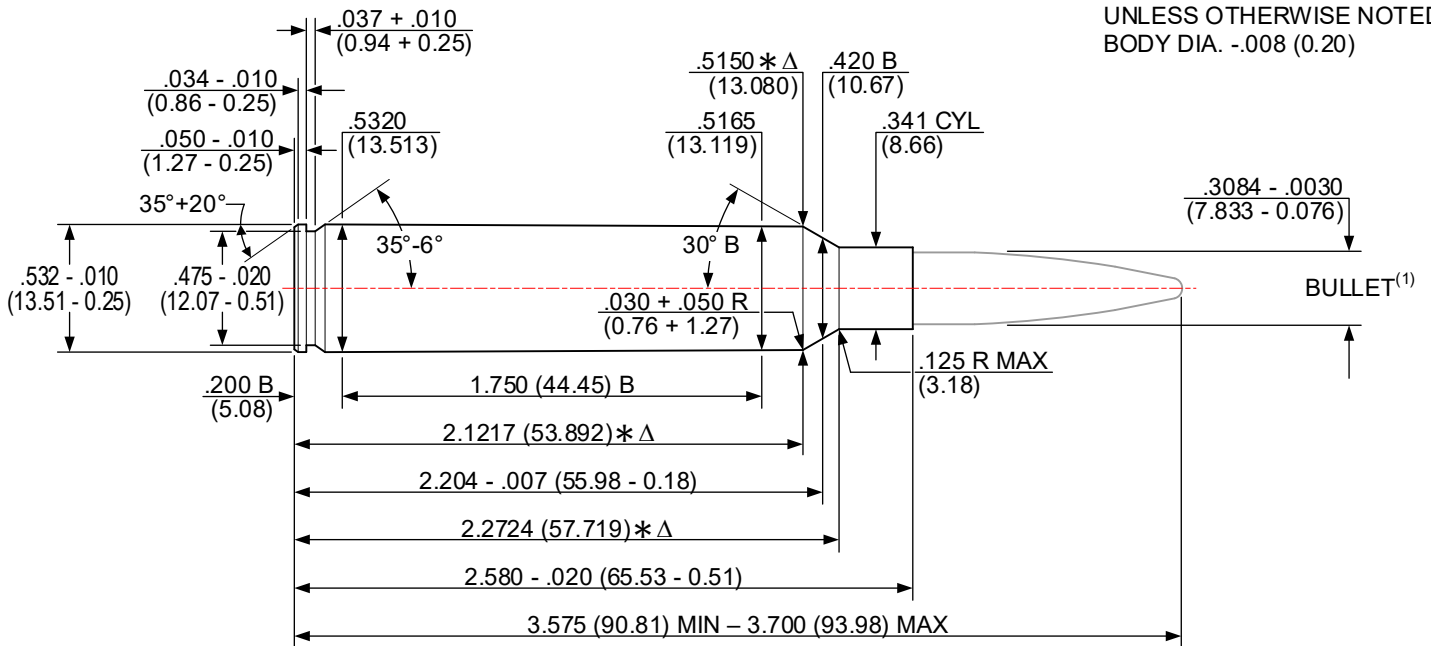

CHAMBER

UNLESS OTHERWISE NOTED
 ALL DIA +.002 (0.05)
 LENGTH TOL. +.015 (0.38)

Δ 6 GROOVES TWIST: 8.50 (215.9) R.H. OPTIONAL
 $\Delta .115 + .002$ (2.92 + 0.05) WIDE MINIMUM BORE & GROOVE AREA: .0735 inch² (47.419 mm²)

NOTES:

B = BASIC (XX.XX) = MILLIMETERS \otimes = HEADSPACE DIMENSION
 Δ = REFERENCE DIMENSION * = DIMENSIONS ARE TO INTERSECTION OF LINES
 ALL CALCULATIONS APPLY AT MAXIMUM MATERIAL CONDITION (MMC)
 (1) – BULLET PROFILE IS SHOWN FOR ILLUSTRATIVE PURPOSES ONLY

DO NOT SCALE FROM DRAWING

NOTICE: This drawing is subject to change.
 Revisions, if applicable, are available at www.saami.org.

300 REMINGTON SHORT ACTION ULTRA MAGNUM [300 REM SA ULTRA MAG]
 ISSUED: 02/01/2002 REVISED: 05/25/2022

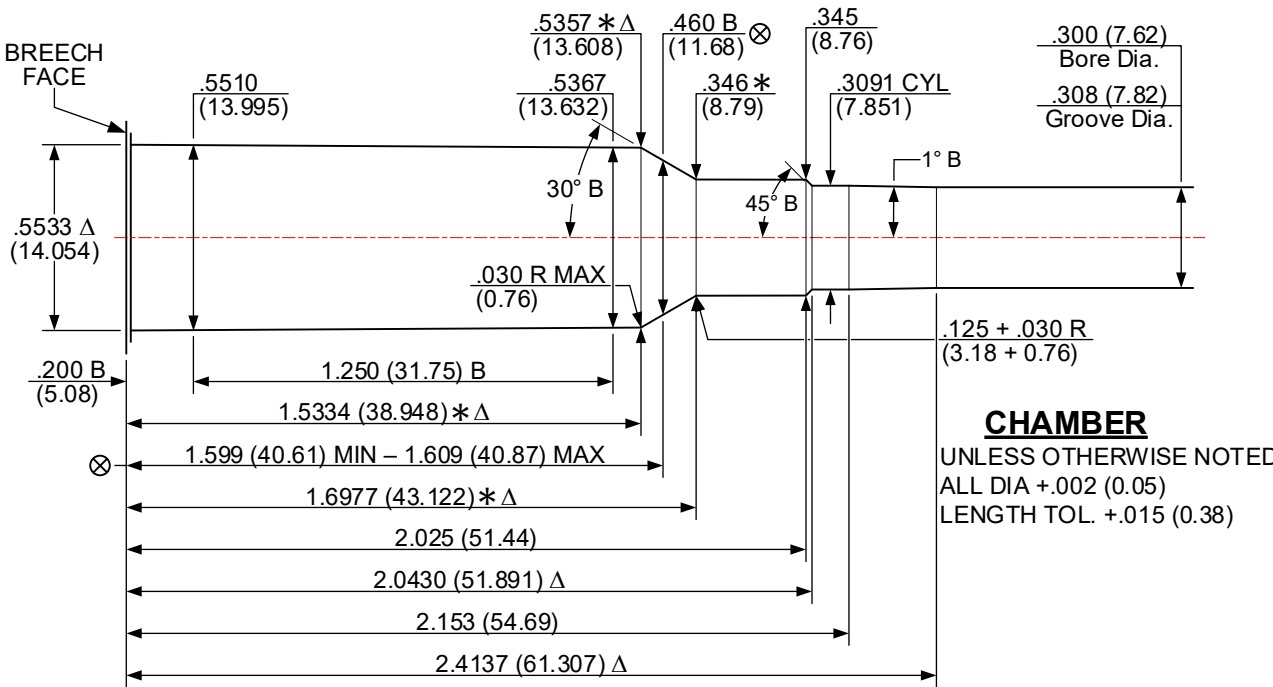
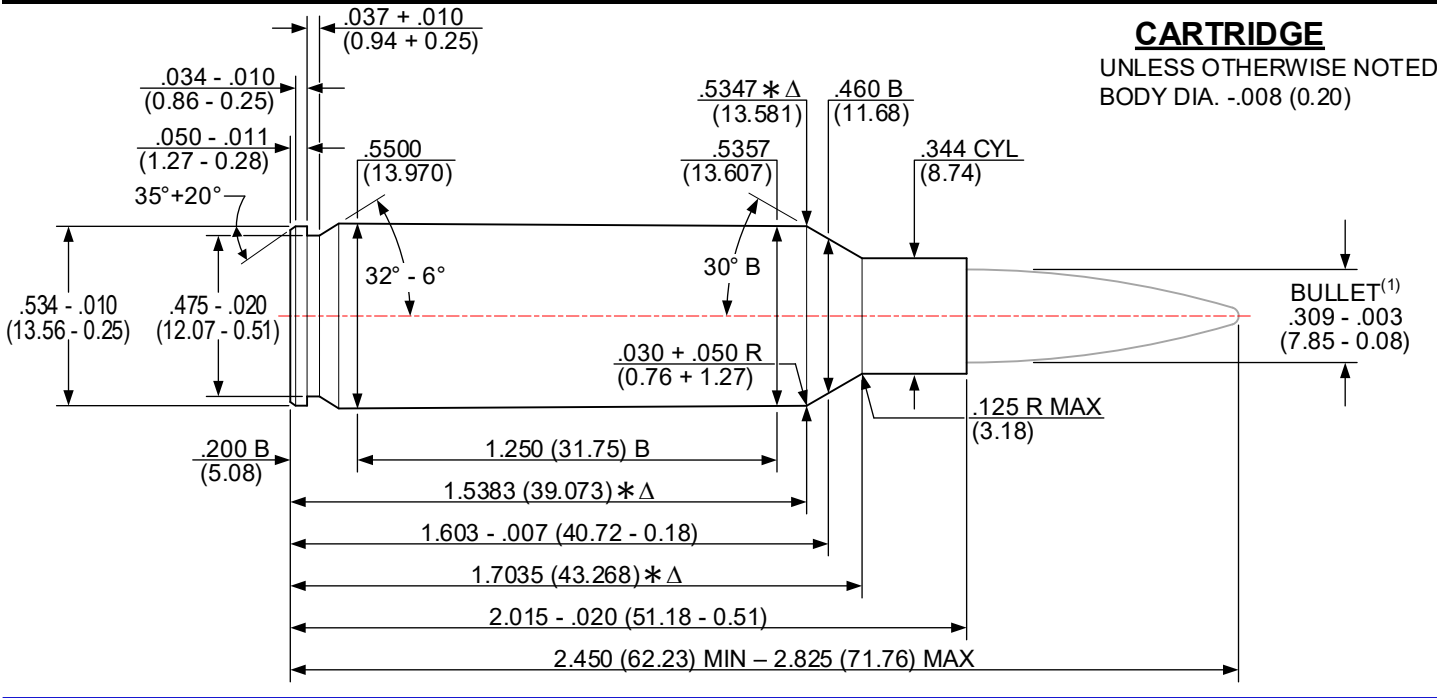

Δ 6 GROOVES TWIST: 10.00 (254.0) R.H. OPTIONAL
 Δ .110+.002 (2.79+0.05) WIDE MINIMUM BORE & GROOVE AREA: .0733 in² (47.290 mm²)

NOTES:
 B = BASIC (XX.XX) = MILLIMETERS ⊗ = HEADSPACE DIMENSION
 Δ = REFERENCE DIMENSION * = DIMENSIONS ARE TO INTERSECTION OF LINES
 ALL CALCULATIONS APPLY AT MAXIMUM MATERIAL CONDITION (MMC)
 (1) – BULLET PROFILE IS SHOWN FOR ILLUSTRATIVE PURPOSES ONLY

DO NOT SCALE FROM DRAWING

NOTICE: This drawing is subject to change.
 Revisions, if applicable, are available at www.saami.org.

ISSUED: 01/07/1999 **300 REMINGTON ULTRA MAGNUM [300 REM ULTRA MAG]** REVISED: 05/26/2022

CARTRIDGE

UNLESS OTHERWISE NOTED
 BODY DIA. -.008 (0.20)

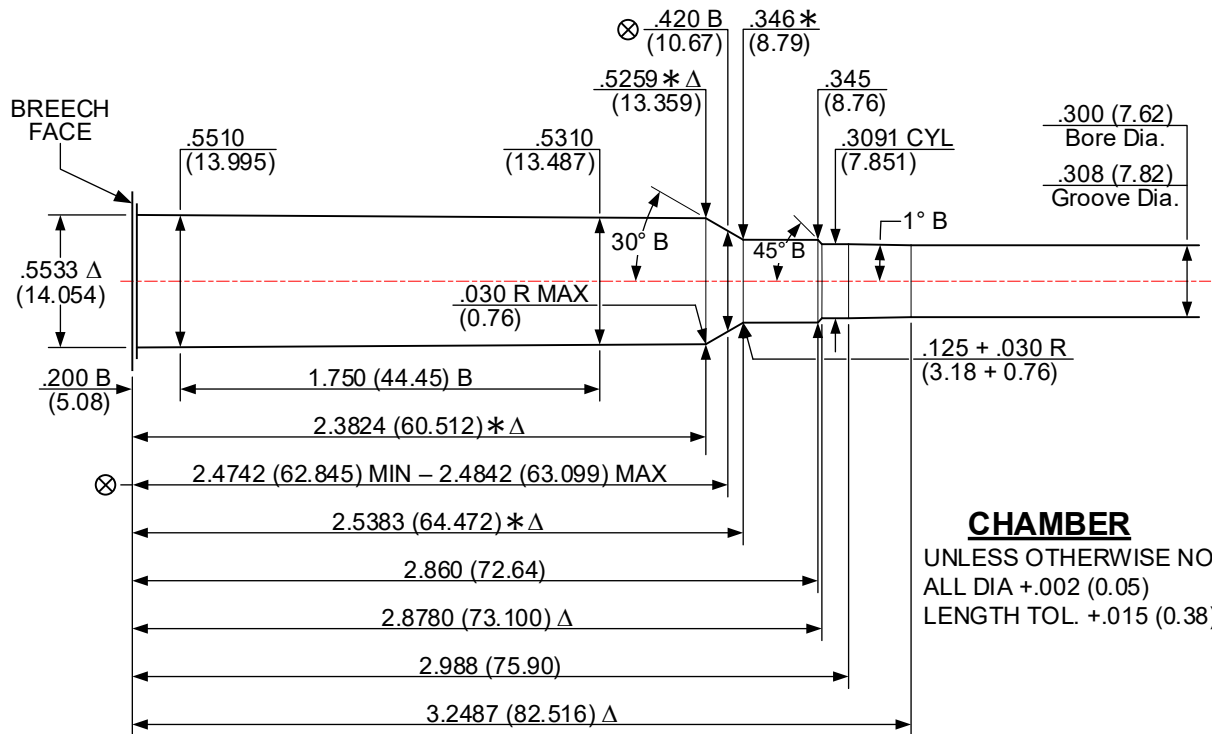
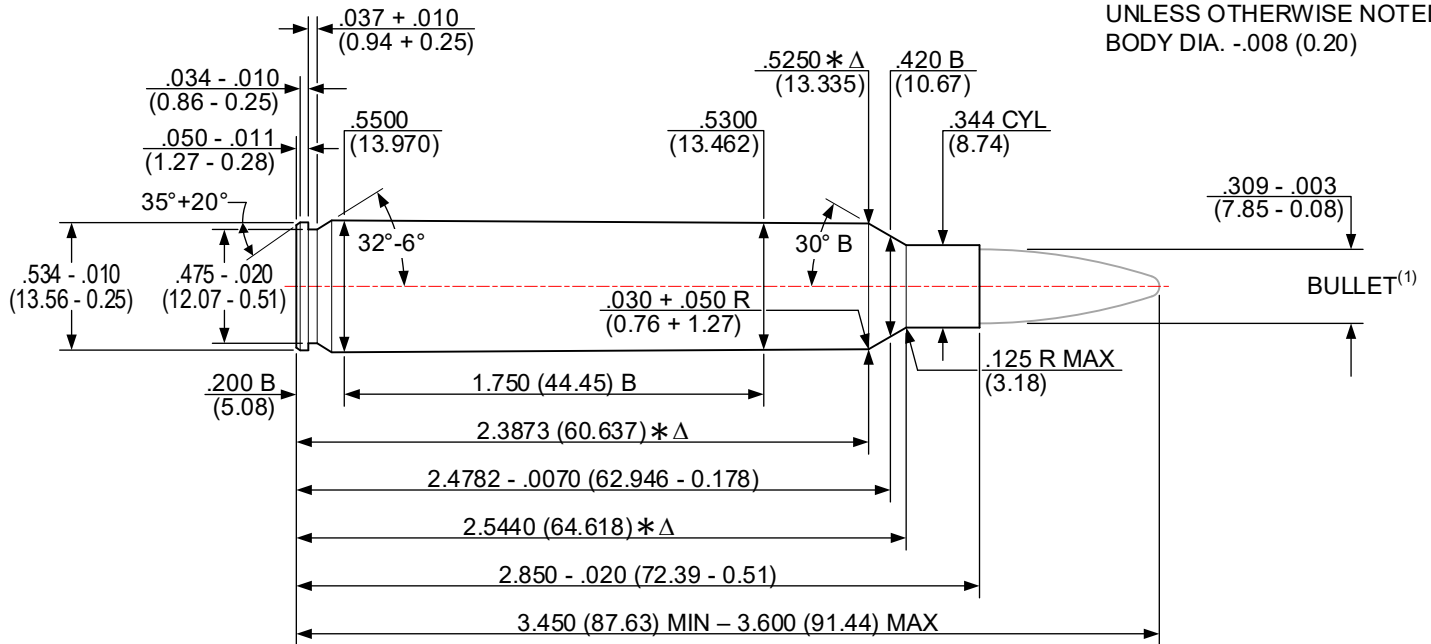

CHAMBER

UNLESS OTHERWISE NOTED
 ALL DIA +.002 (0.05)
 LENGTH TOL. +.015 (0.38)

Δ 6 GROOVES

Δ .115 + .002 (2.92 + 0.05) WIDE

TWIST: 10.00 (254.0) R.H. OPTIONAL

MINIMUM BORE & GROOVE AREA: .0735 in² (47.419 mm²)

NOTES:

B = BASIC

(XX.XX) = MILLIMETERS

⊗ = HEADSPACE DIMENSION

Δ = REFERENCE DIMENSION

* = DIMENSIONS ARE TO INTERSECTION OF LINES

ALL CALCULATIONS APPLY AT MAXIMUM MATERIAL CONDITION (MMC)

(1) – BULLET PROFILE IS SHOWN FOR ILLUSTRATIVE PURPOSES ONLY

DO NOT SCALE FROM DRAWING

ISSUED: 12/30/2008

300 RUGER COMPACT MAGNUM [300 RCM]

REVISED: 05/26/2022

Note - The User's attention is called to the fact that an assurance has been provided by a person claiming to own intellectual property rights that will be necessarily infringed by use of this Standard, and that such person is prepared to grant non-exclusive licenses in connection with such intellectual property rights on reasonable terms and conditions, which may be royalty bearing or royalty free as shall be negotiated, and free of any demonstrably unfair discrimination. Further information may be obtained from SAAMI's Technical Office.

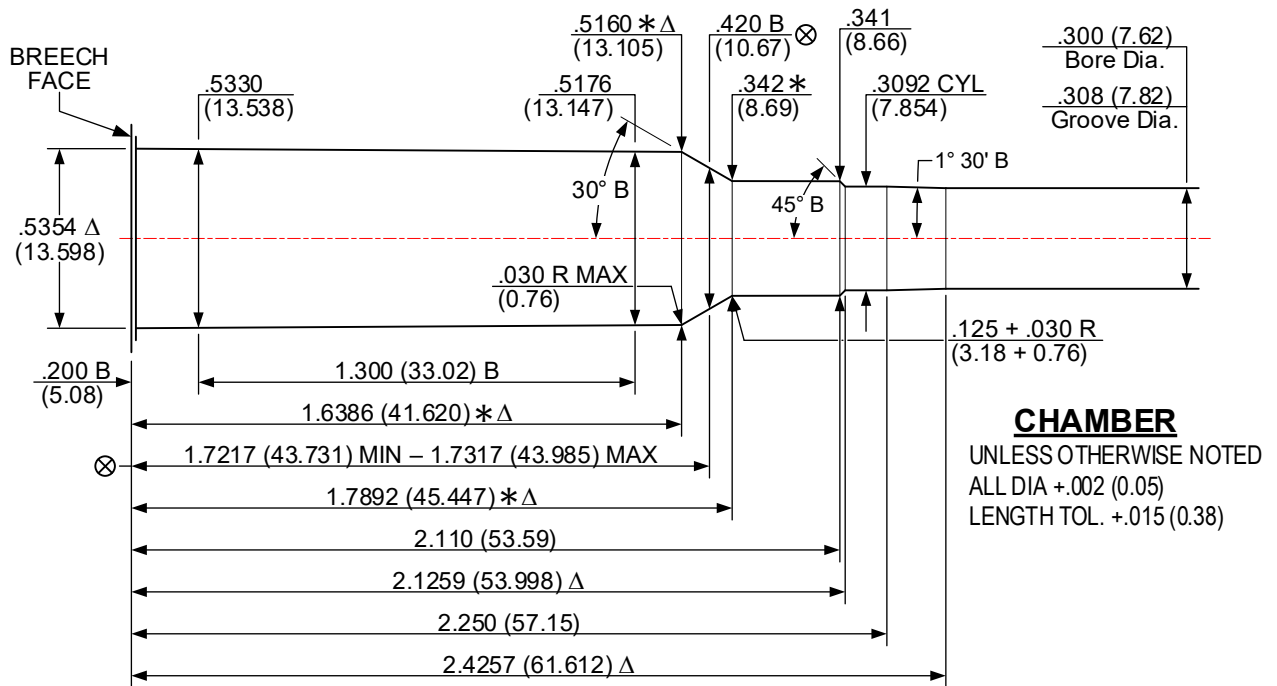
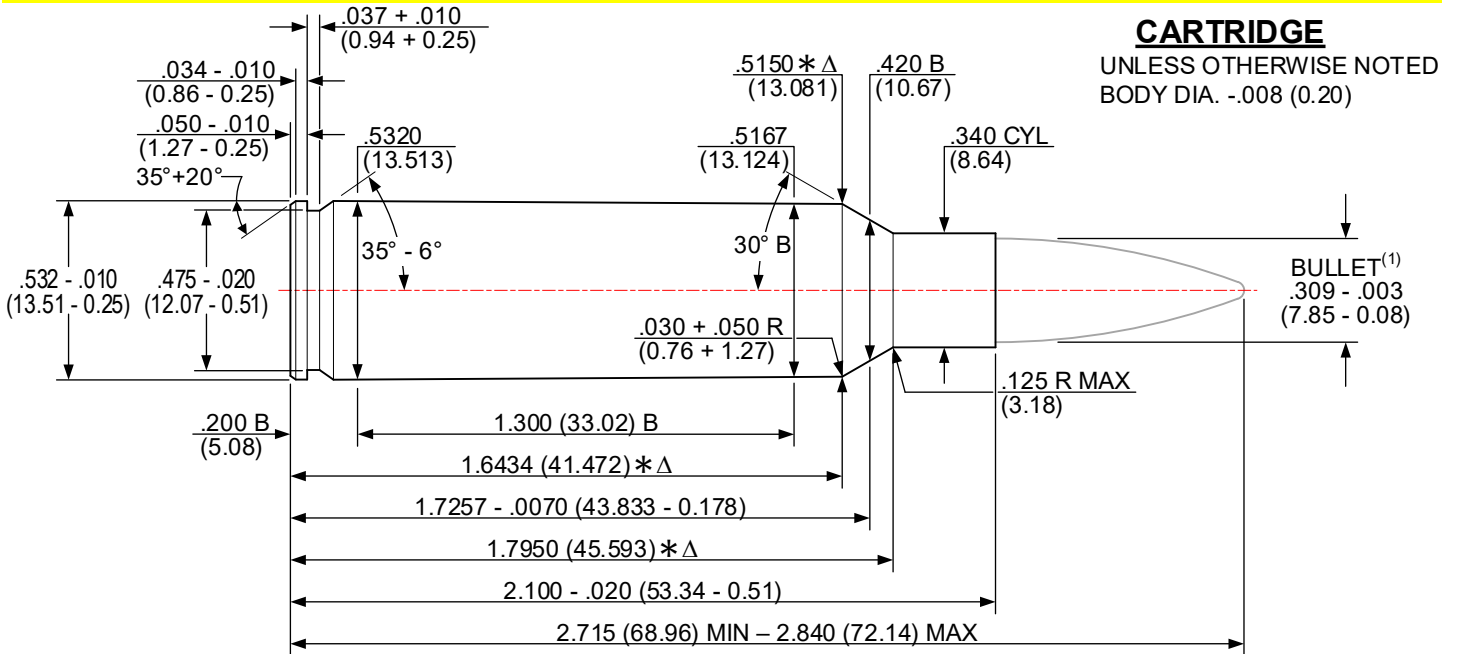

Δ 6 GROOVES TWIST: 10.00 (254.0) R.H. OPTIONAL
 Δ .110+.002 (2.79+0.05) WIDE MINIMUM BORE & GROOVE AREA: .0733 in² (47.290 mm²)

NOTES:

- B = BASIC (XX.XX) = MILLIMETERS ⊗ = HEADSPACE DIMENSION
- Δ = REFERENCE DIMENSION * = DIMENSIONS ARE TO INTERSECTION OF LINES
- ALL CALCULATIONS APPLY AT MAXIMUM MATERIAL CONDITION (MMC)
- (1) - BULLET PROFILE IS SHOWN FOR ILLUSTRATIVE PURPOSES ONLY

DO NOT SCALE FROM DRAWING

NOTICE: This drawing is subject to change.
 Revisions, if applicable, are available at www.saami.org.

ISSUED: 05/29/1979 **300 SAVAGE [300 SAV]** REVISED: 05/27/2022

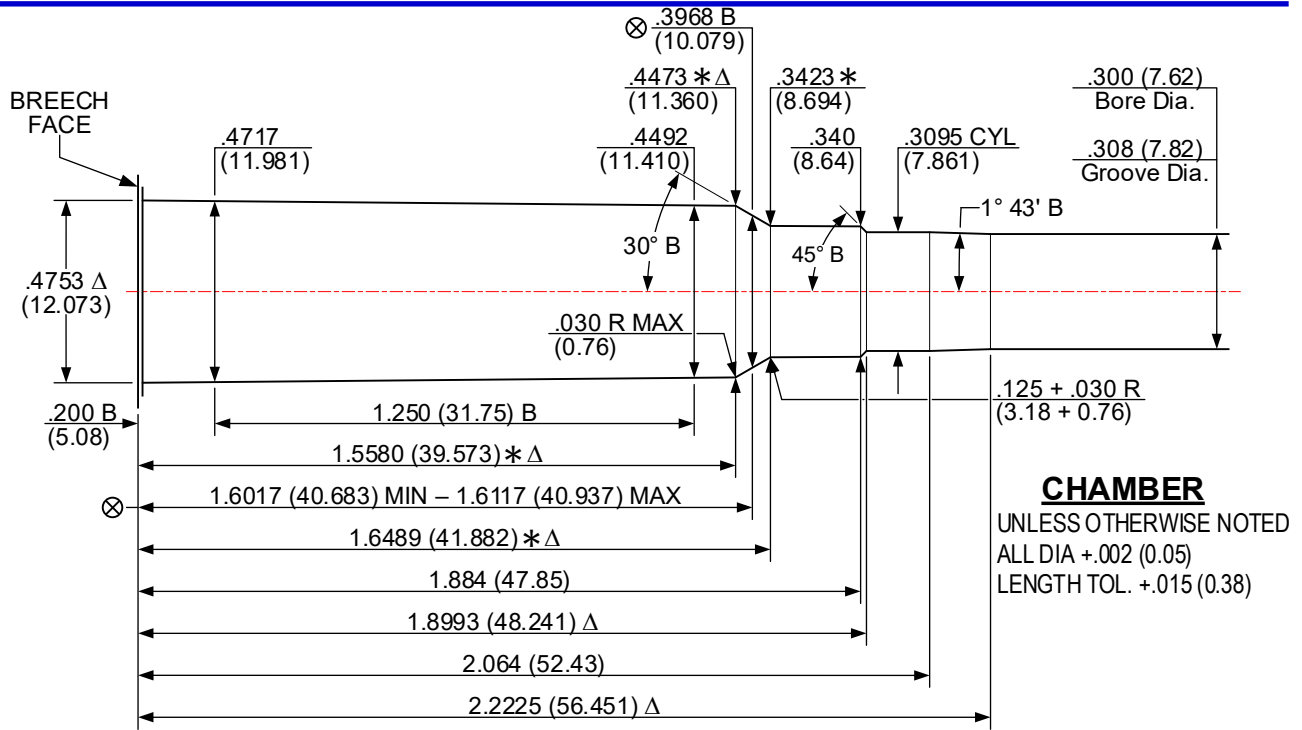
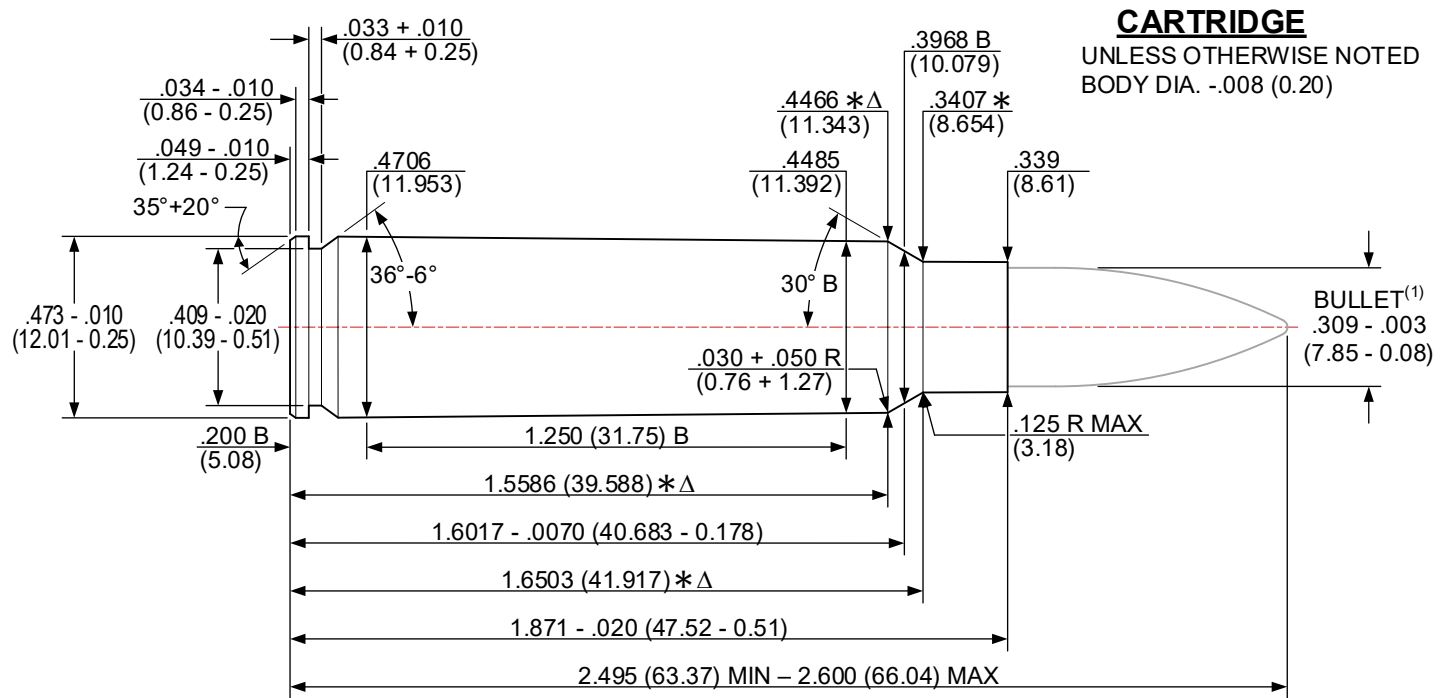

Δ 6 GROOVES TWIST: 12.00 (304.8) R.H. OPTIONAL
 Δ .095 + .002 (2.41 + 0.05) WIDE MINIMUM BORE & GROOVE AREA: .0730 in² (47.096 mm²)

NOTES:
 B = BASIC (XX.XX) = MILLIMETERS ⊗ = HEADSPACE DIMENSION
 Δ = REFERENCE DIMENSION * = DIMENSIONS ARE TO INTERSECTION OF LINES
 ALL CALCULATIONS APPLY AT MAXIMUM MATERIAL CONDITION (MMC)
 (1) – BULLET PROFILE IS SHOWN FOR ILLUSTRATIVE PURPOSES ONLY

DO NOT SCALE FROM DRAWING

ISSUED: 02/01/1990 **300 WEATHERBY MAGNUM [300 WBY MAG]** REVISED: 01/21/2024

CARTRIDGE

UNLESS OTHERWISE NOTED
 BODY DIA. -.004 (0.10)

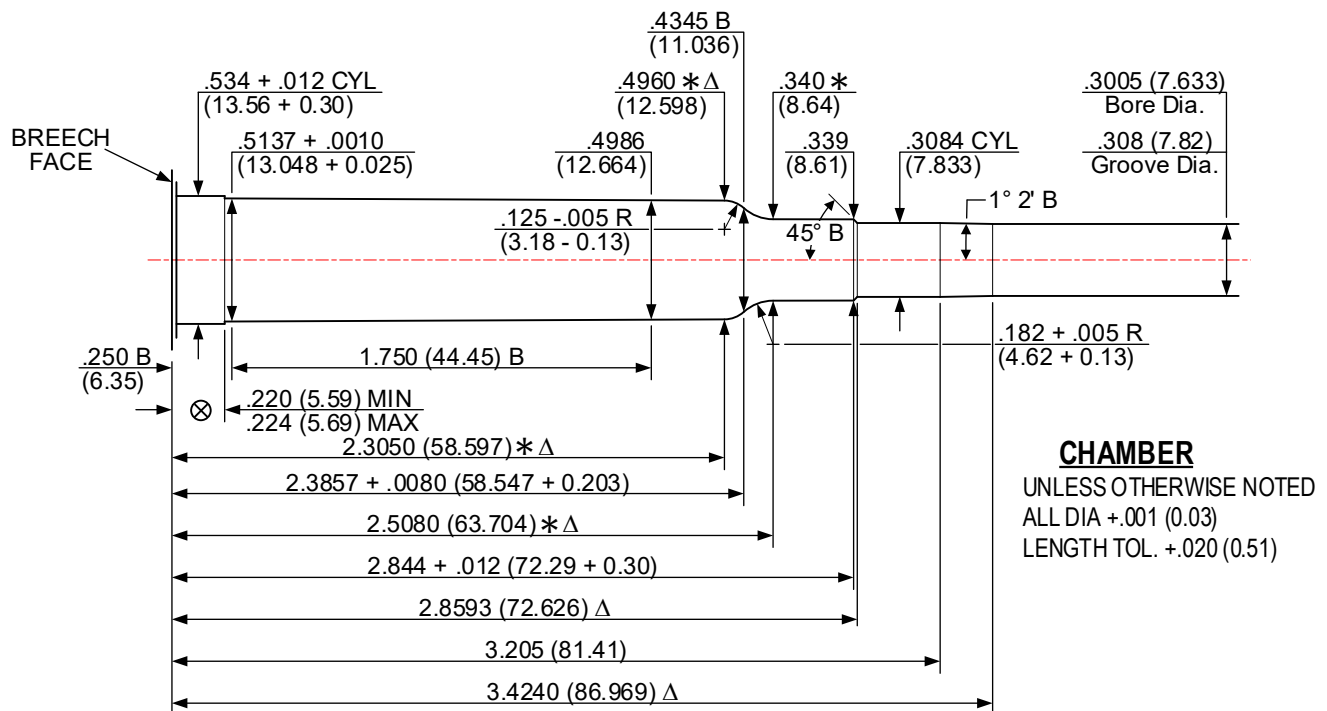
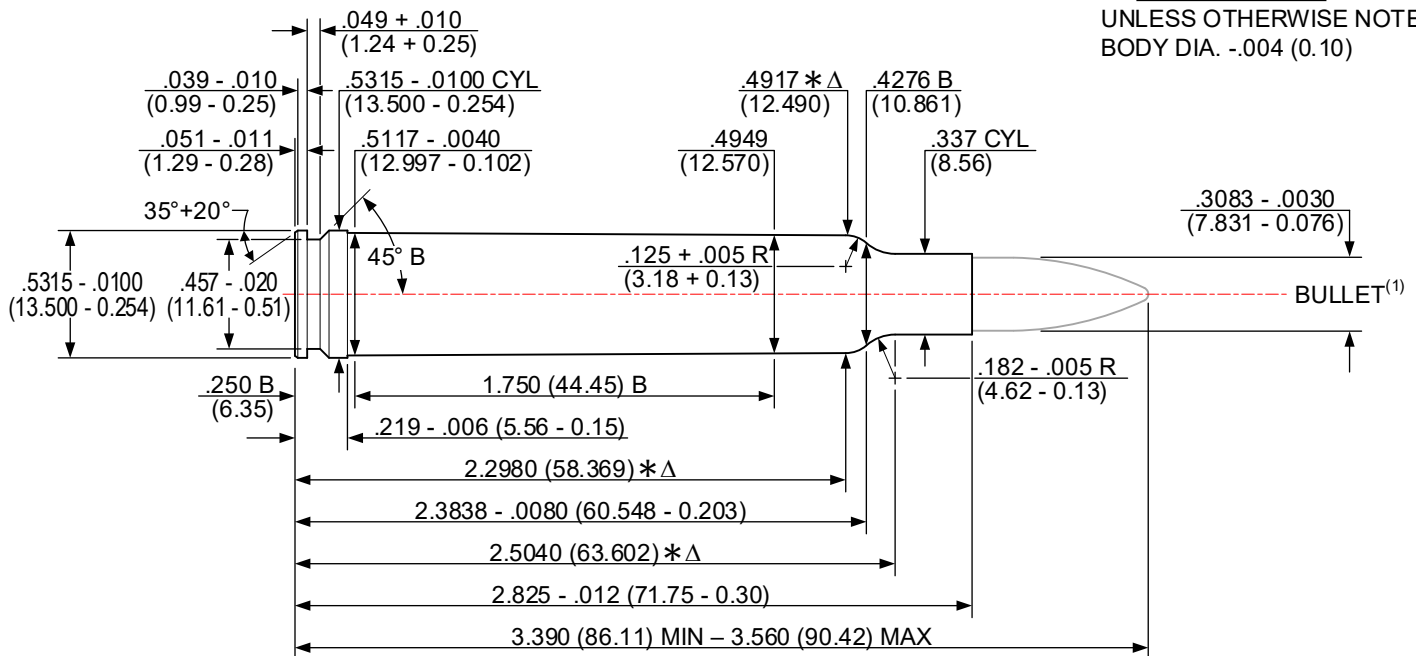

Δ 6 GROOVES TWIST: 10.00 (254.0) R.H. OPTIONAL
 Δ .118+.002 (3.00+0.05) WIDE MINIMUM BORE & GROOVE AREA: .0736 in² (47.483 mm²)

NOTE:
 B = BASIC (XX.XX) = MILLIMETERS ⊗ = HEADSPACE DIMENSION
 Δ = REFERENCE DIMENSION * = DIMENSIONS ARE TO INTERSECTION OF LINES
 ALL CALCULATIONS APPLY AT MAXIMUM MATERIAL CONDITION (MMC)
 (1) – BULLET PROFILE IS SHOWN FOR ILLUSTRATIVE PURPOSES ONLY

DO NOT SCALE FROM DRAWING

NOTICE: This drawing is subject to change.
 Revisions, if applicable, are available at www.saami.org.

ISSUED: 04/21/1980 **300 WINCHESTER MAGNUM [300 WIN MAG]** REVISED: 05/31/2022

CARTRIDGE
 UNLESS OTHERWISE NOTED
 BODY DIA. -.008 (0.20)

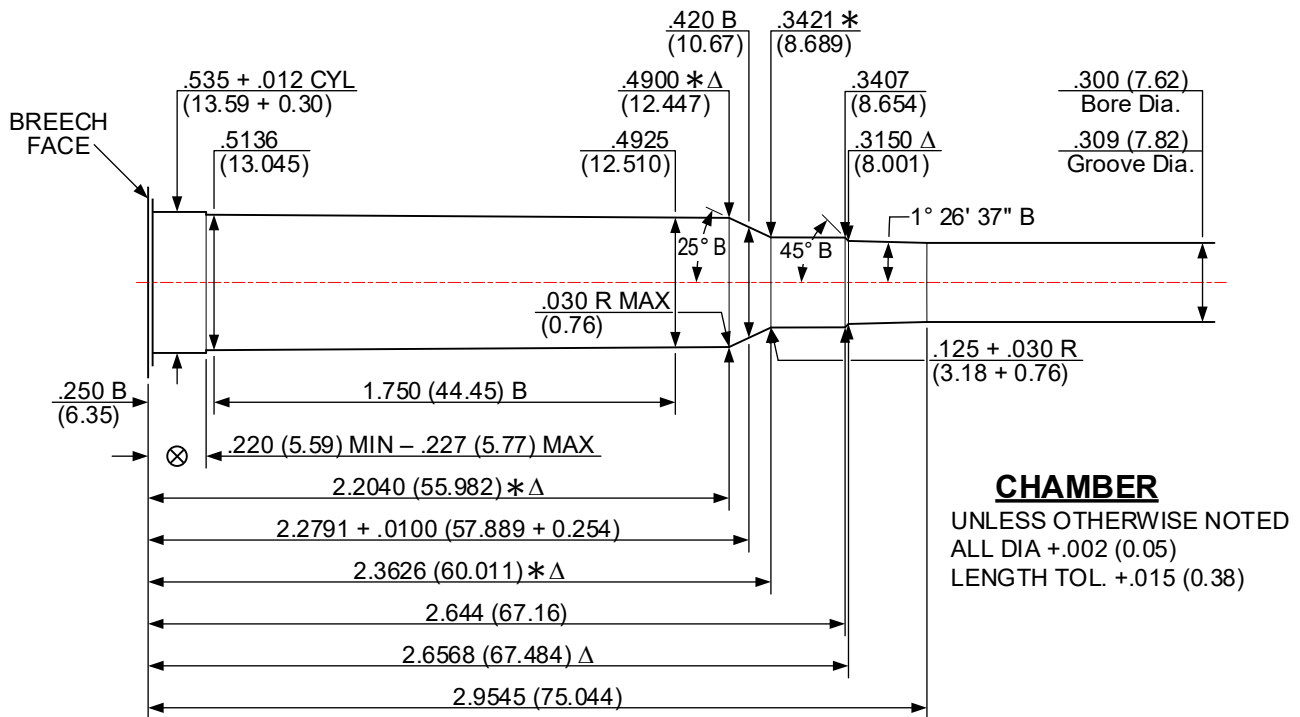
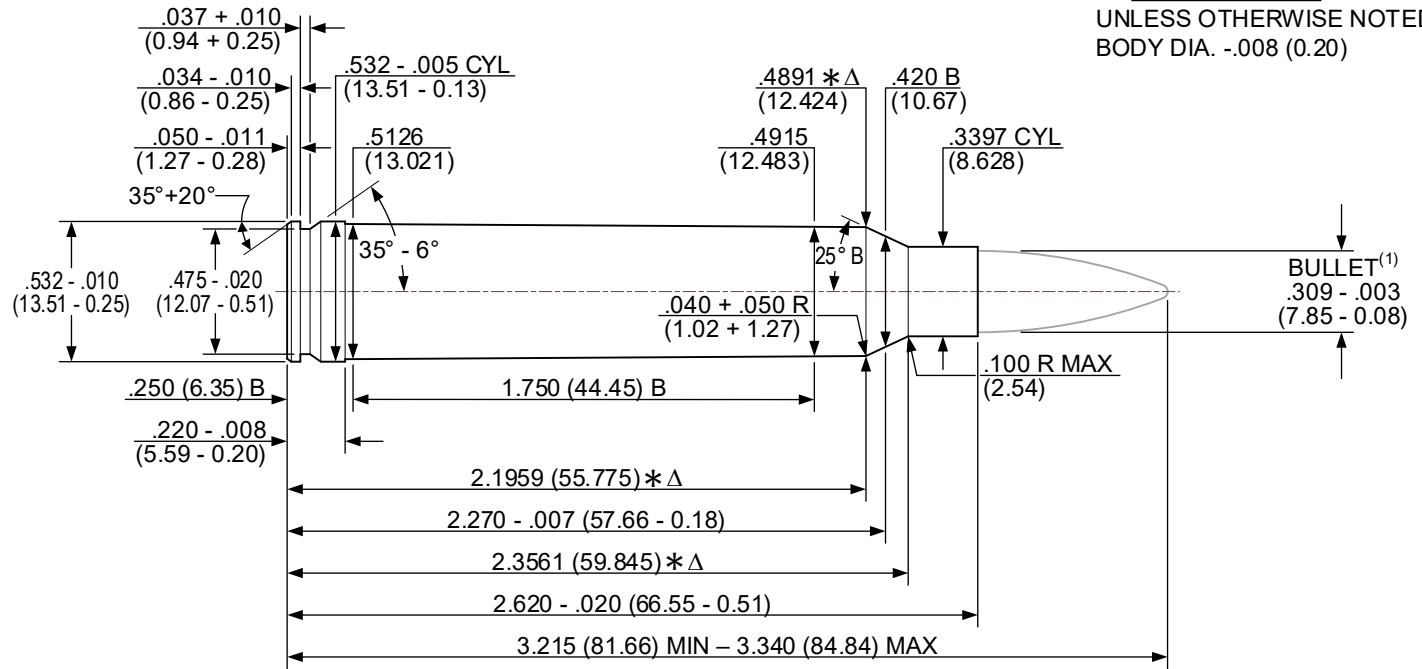

△ 6 GROOVES TWIST: 10.00 (254.0) R.H. OPTIONAL
 △ .110+.002 (2.79+0.05) WIDE MINIMUM BORE & GROOVE AREA: .0733 in² (47.290 mm²)

NOTES:
 B = BASIC (XX.XX) = MILLIMETERS ⊗ = HEADSPACE DIMENSION
 △ = REFERENCE DIMENSION * = DIMENSIONS ARE TO INTERSECTION OF LINES
 ALL CALCULATIONS APPLY AT MAXIMUM MATERIAL CONDITION (MMC)
 (1) – BULLET PROFILE IS SHOWN FOR ILLUSTRATIVE PURPOSES ONLY

DO NOT SCALE FROM DRAWING

ISSUED: 06/13/2001 **300 WINCHESTER SHORT MAGNUM [300 WSM]** REVISED: 06/01/2022

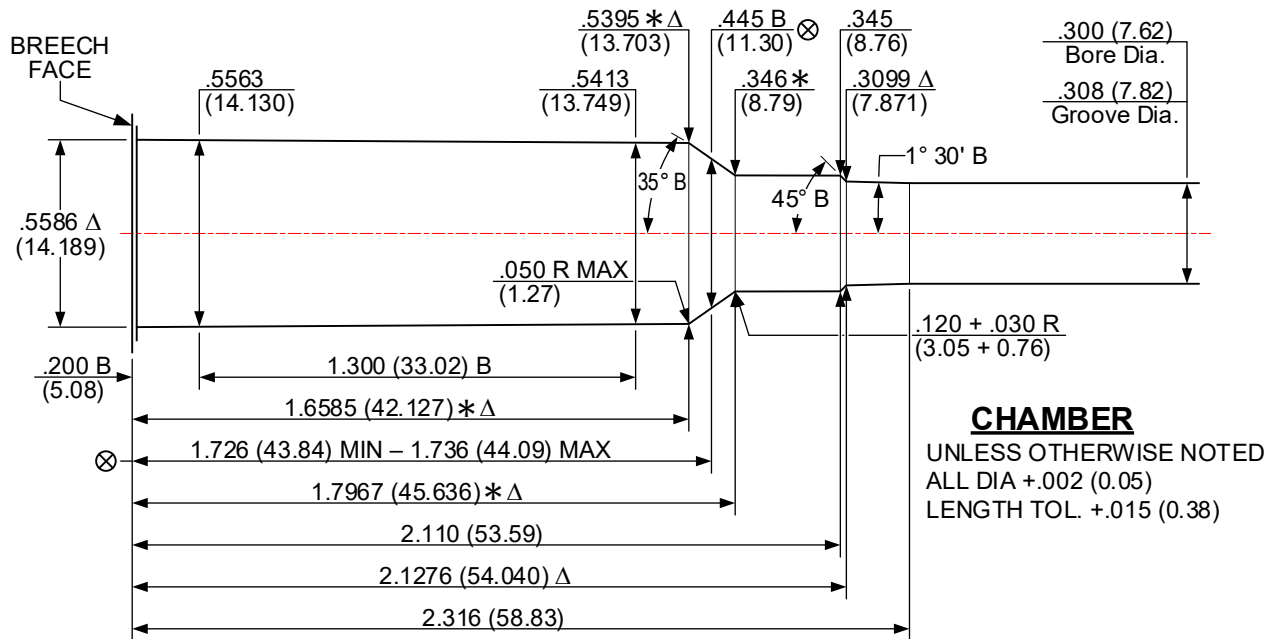
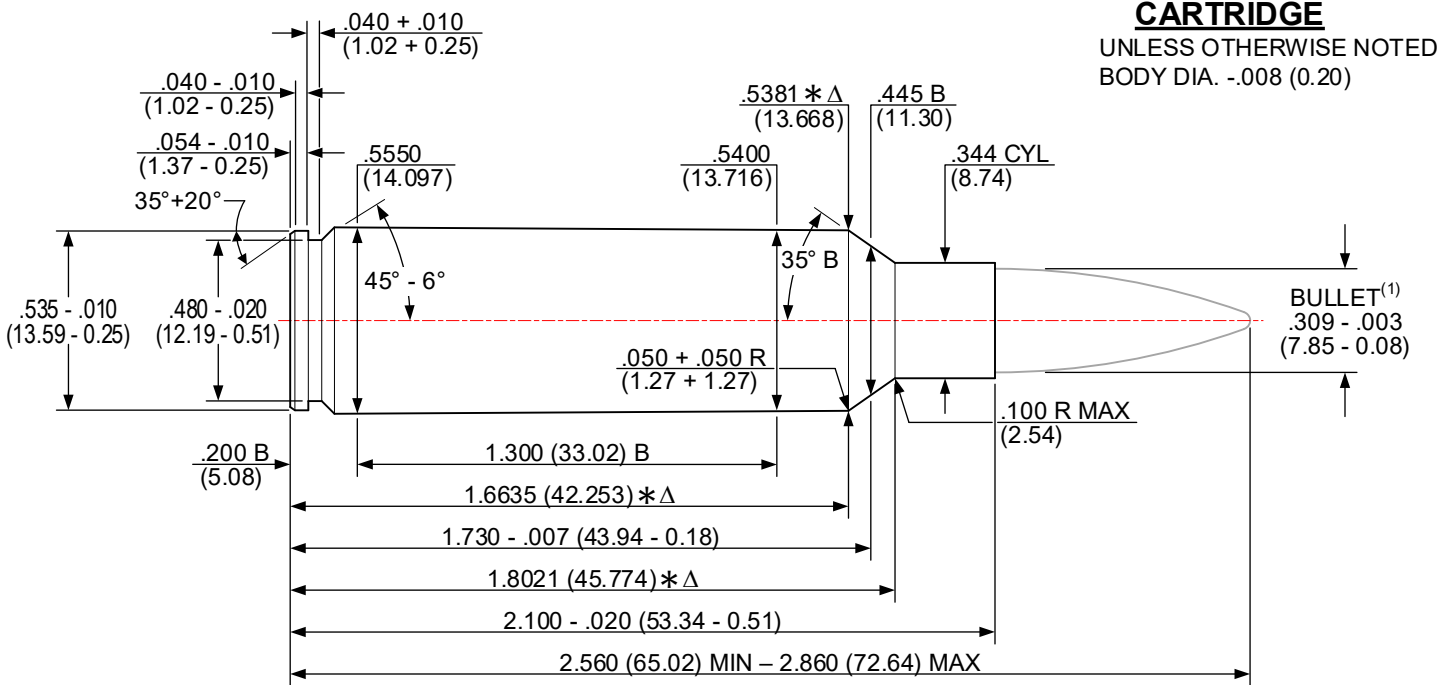

Δ 4 GROOVES
 Δ .1767+.0020 (4.488+0.051) WIDE

TWIST: 10.00 (254.0) R.H. OPTIONAL
 MINIMUM BORE & GROOVE AREA: .0737 in² (47.548 mm²)

NOTES:

- B = BASIC
- Δ = REFERENCE DIMENSION
- ALL CALCULATIONS APPLY AT MAXIMUM MATERIAL CONDITION (MMC)
- (1) – BULLET PROFILE IS SHOWN FOR ILLUSTRATIVE PURPOSES ONLY
- (XX.XX) = MILLIMETERS
- * = DIMENSIONS ARE TO INTERSECTION OF LINES
- ⊗ = HEADSPACE DIMENSION

DO NOT SCALE FROM DRAWING

NOTICE: This drawing is subject to change.
 Revisions, if applicable, are available at www.saami.org.

ISSUED: 05/29/1979 **303 BRITISH [303 BRIT]** REVISED: 02/10/2023

CARTRIDGE
 UNLESS OTHERWISE NOTED
 BODY DIA. -.008 (0.20)

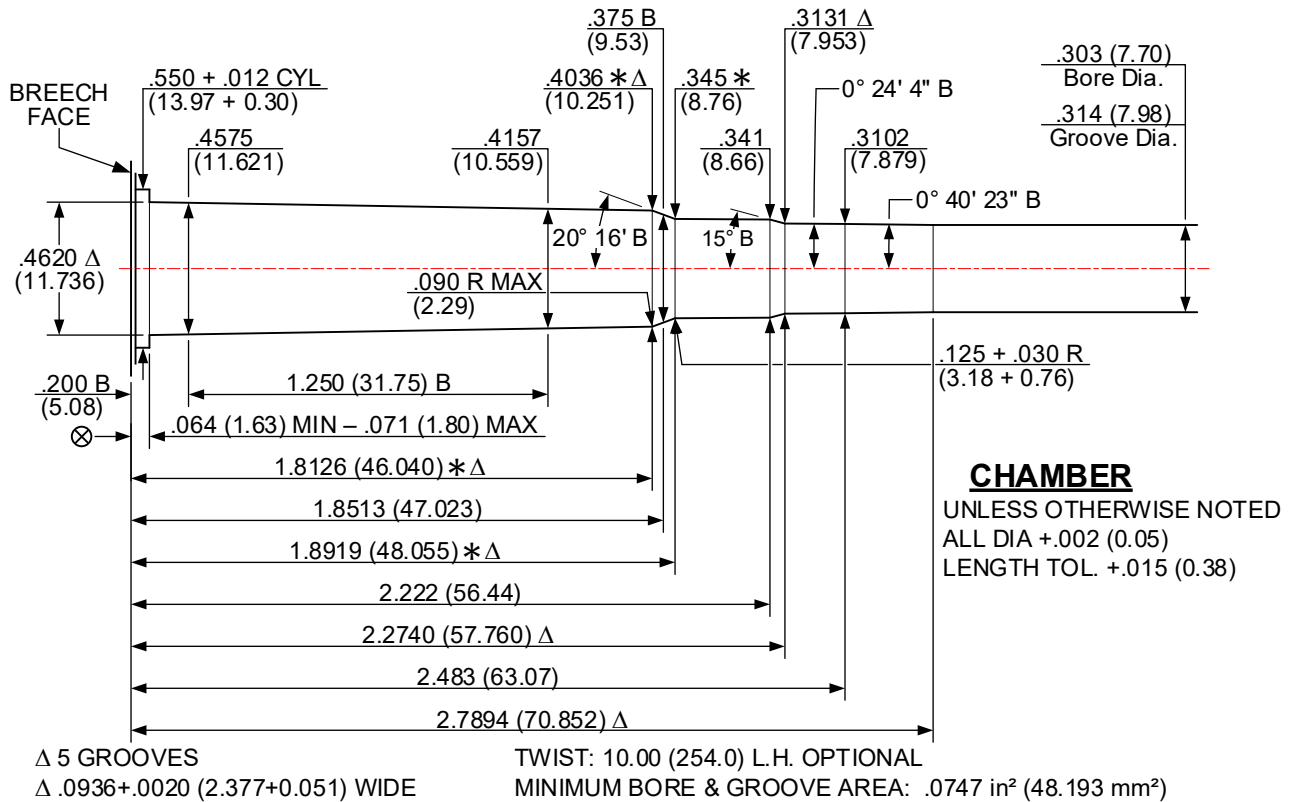
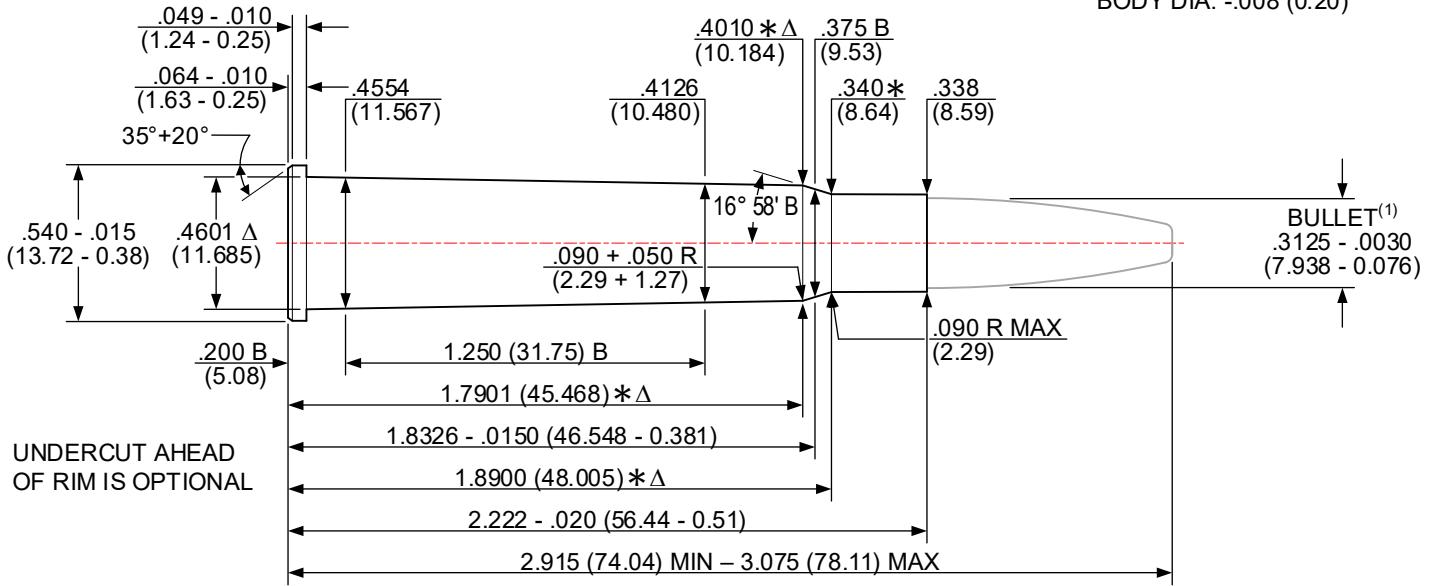

NOTES:
 B = BASIC (XX.XX) = MILLIMETERS ⊗ = HEAD SPACE DIMENSION
 Δ = REFERENCE DIMENSION * = DIMENSIONS ARE TO INTERSECTION OF LINES
 ALL CALCULATIONS APPLY AT MAXIMUM MATERIAL CONDITION (MMC)
 (1) – BULLET PROFILE IS SHOWN FOR ILLUSTRATIVE PURPOSES ONLY

CHAMBER
 UNLESS OTHERWISE NOTED
 ALL DIA +.002 (0.05)
 LENGTH TOL. +.015 (0.38)

Δ 5 GROOVES TWIST: 10.00 (254.0) L.H. OPTIONAL
 Δ .0936+.0020 (2.377+0.051) WIDE MINIMUM BORE & GROOVE AREA: .0747 in² (48.193 mm²)

DO NOT SCALE FROM DRAWING

ISSUED: 11/08/1983 **307 WINCHESTER [307 WIN]** REVISED: 06/02/2022

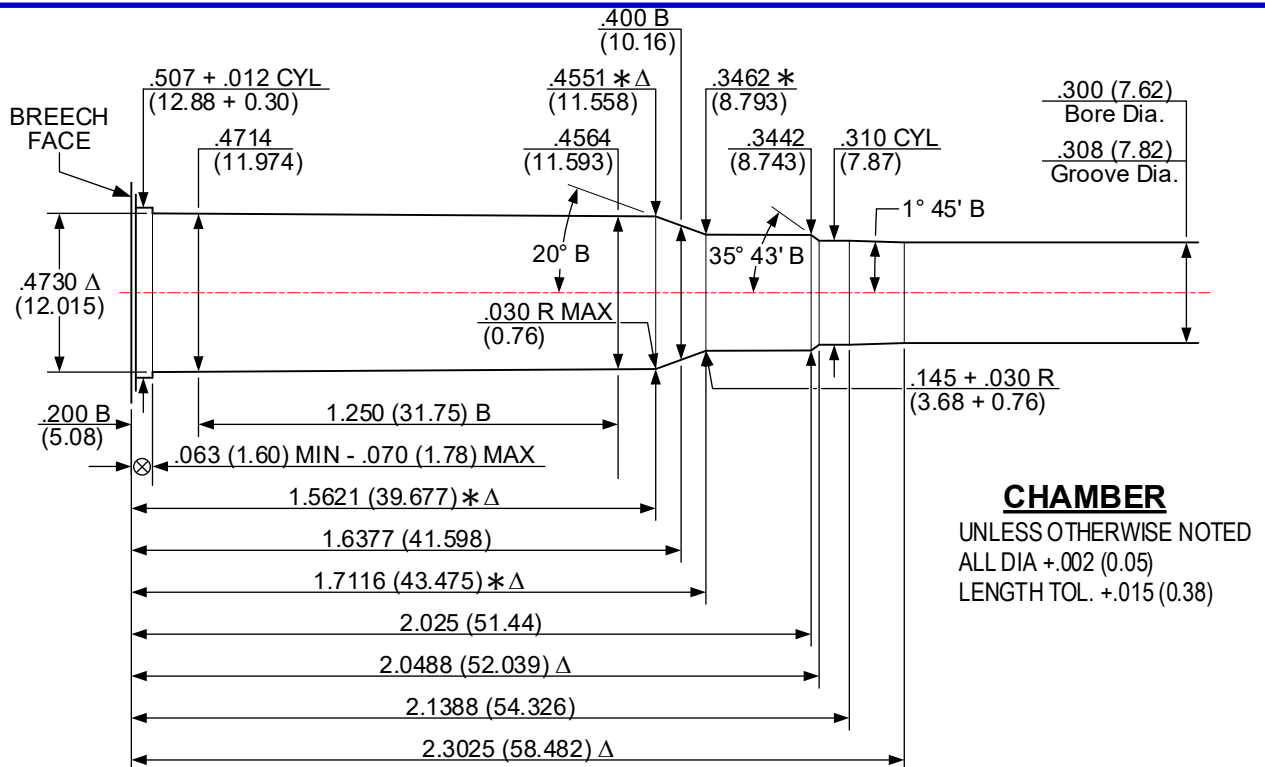
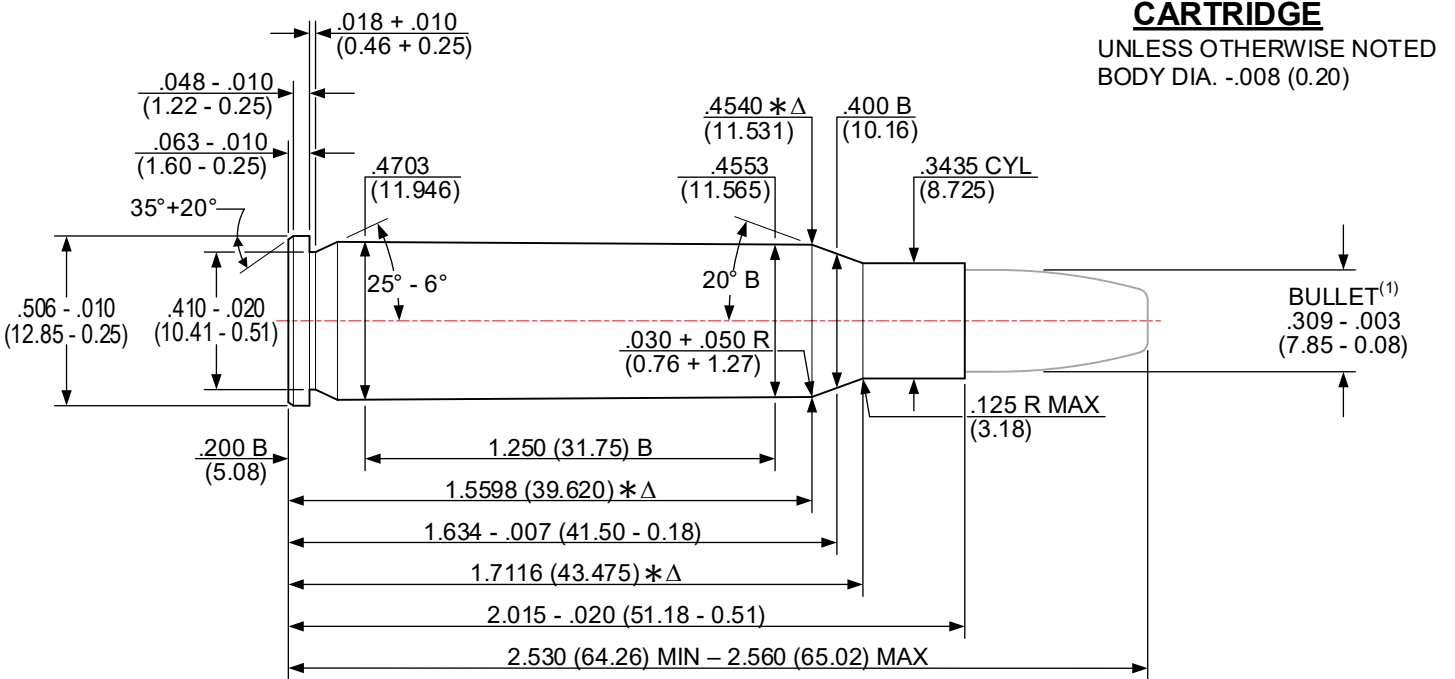

Δ 4 GROOVES TWIST: 12.00 (304.8) R.H. OPTIONAL
 Δ .176+.002 (4.47+0.05) WIDE MINIMUM BORE & GROOVE AREA: .0736 in² (47.483 mm²)

NOTES:
 B = BASIC (XX.XX) = MILLIMETERS ⊗ = HEAD SPACE DIMENSION
 Δ = REFERENCE DIMENSION * = DIMENSIONS ARE TO INTERSECTION OF LINES
 ALL CALCULATIONS APPLY AT MAXIMUM MATERIAL CONDITION (MMC)
 (1) – BULLET PROFILE IS SHOWN FOR ILLUSTRATIVE PURPOSES ONLY

DO NOT SCALE FROM DRAWING

ISSUED: 06/13/2007

308 MARLIN EXPRESS [308 MAR EXP]

REVISED: 06/03/2022

CARTRIDGE

UNLESS OTHERWISE NOTED
 BODY DIA. -.008 (0.20)

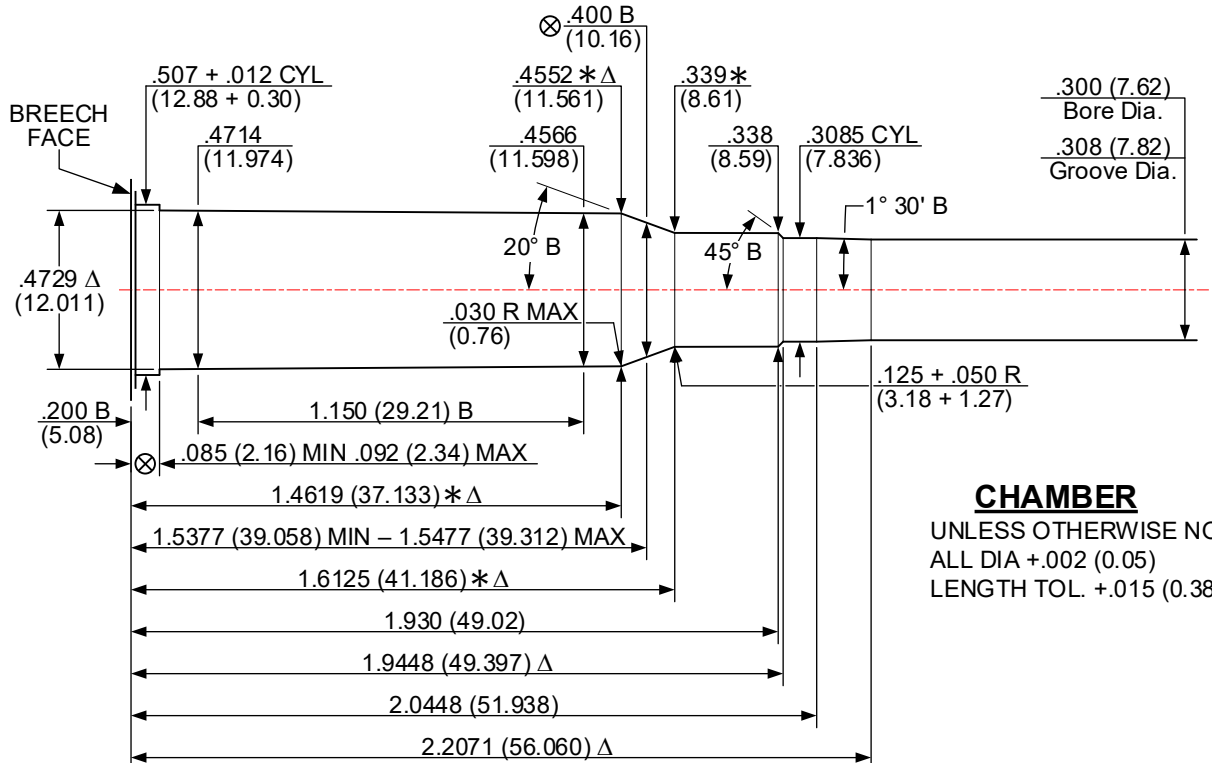
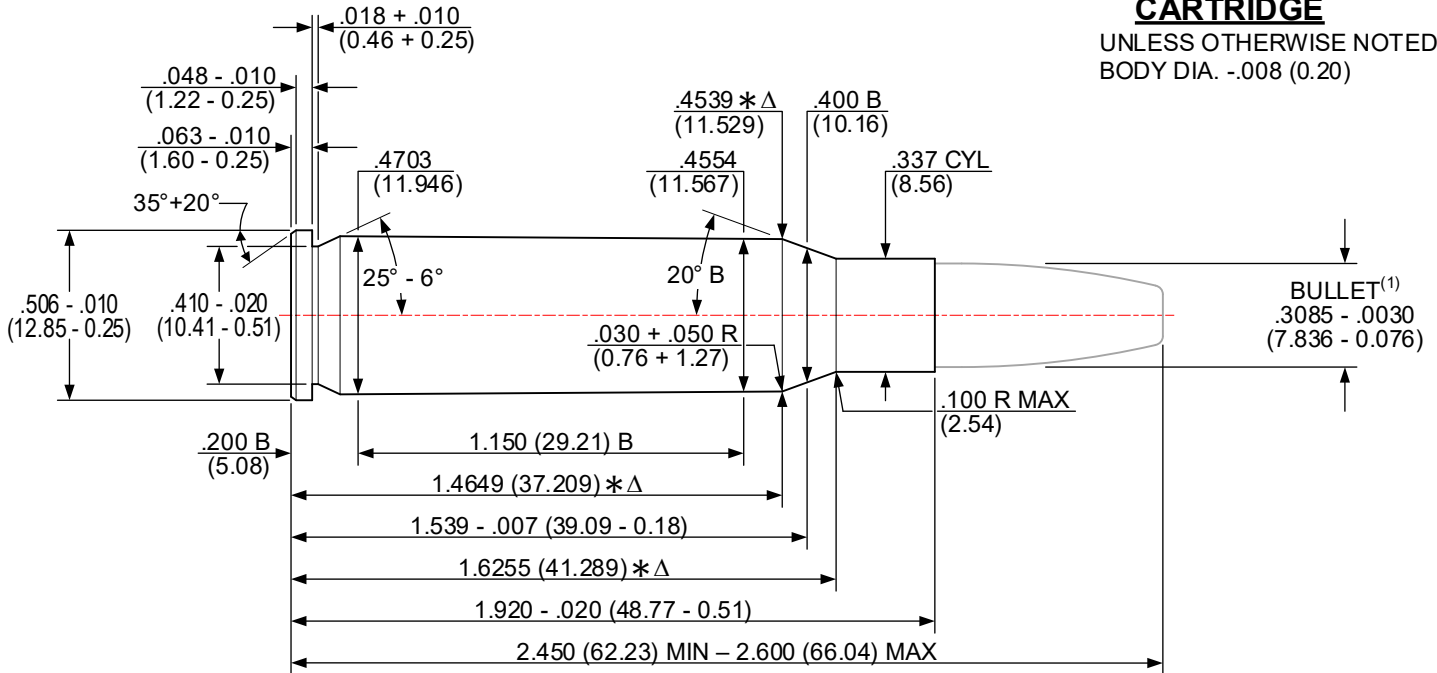

CHAMBER

UNLESS OTHERWISE NOTED
 ALL DIA +.002 (0.05)
 LENGTH TOL. +.015 (0.38)

△ 6 GROOVES

△ .0942+.0020 (2.393+0.051) WIDE

TWIST: 12.00 (304.8) R.H. OPTIONAL

MINIMUM BORE & GROOVE AREA: .0729 in² (47.032 mm²)

NOTES:

B = BASIC

(XX.XX) = MILLIMETERS

⊗ = HEAD SPACE DIMENSION

△ = REFERENCE DIMENSION

* = DIMENSIONS ARE TO INTERSECTION OF LINES

ALL CALCULATIONS APPLY AT MAXIMUM MATERIAL CONDITION (MMC)

(1) – BULLET PROFILE IS SHOWN FOR ILLUSTRATIVE PURPOSES ONLY

DO NOT SCALE FROM DRAWING

ISSUED: 05/29/1979

308 WINCHESTER [308 WIN]

REVISED: 06/03/2022

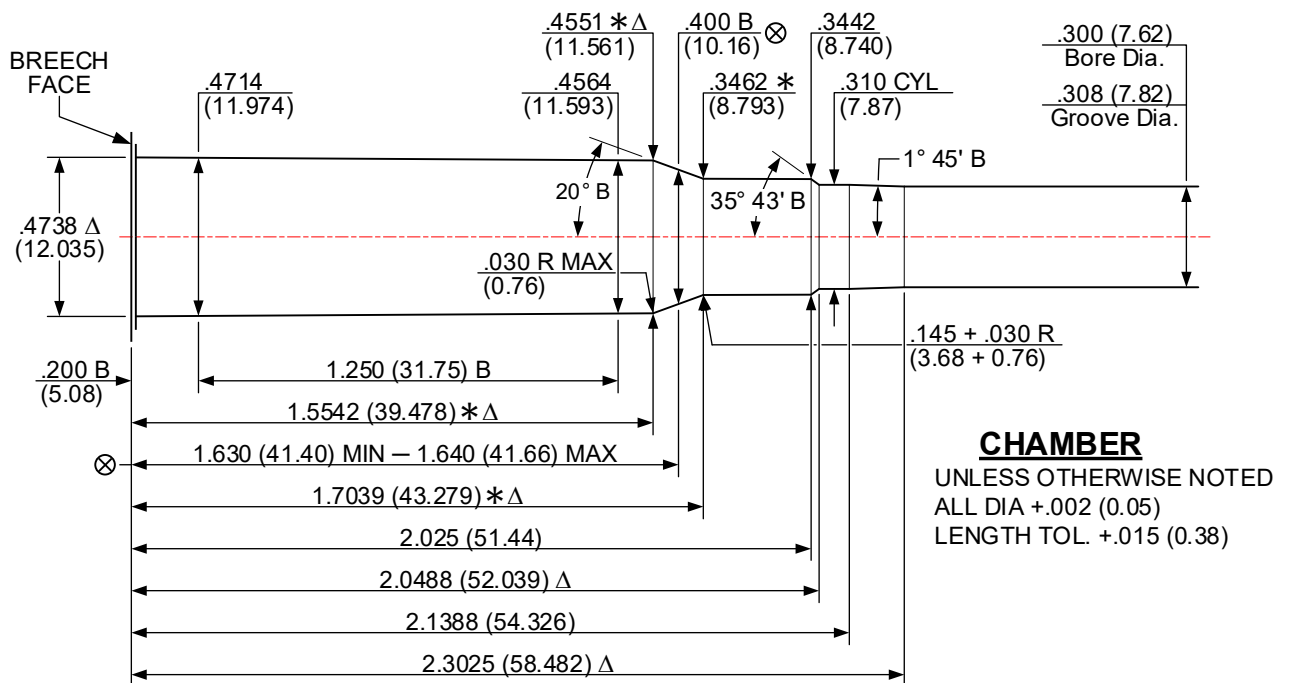
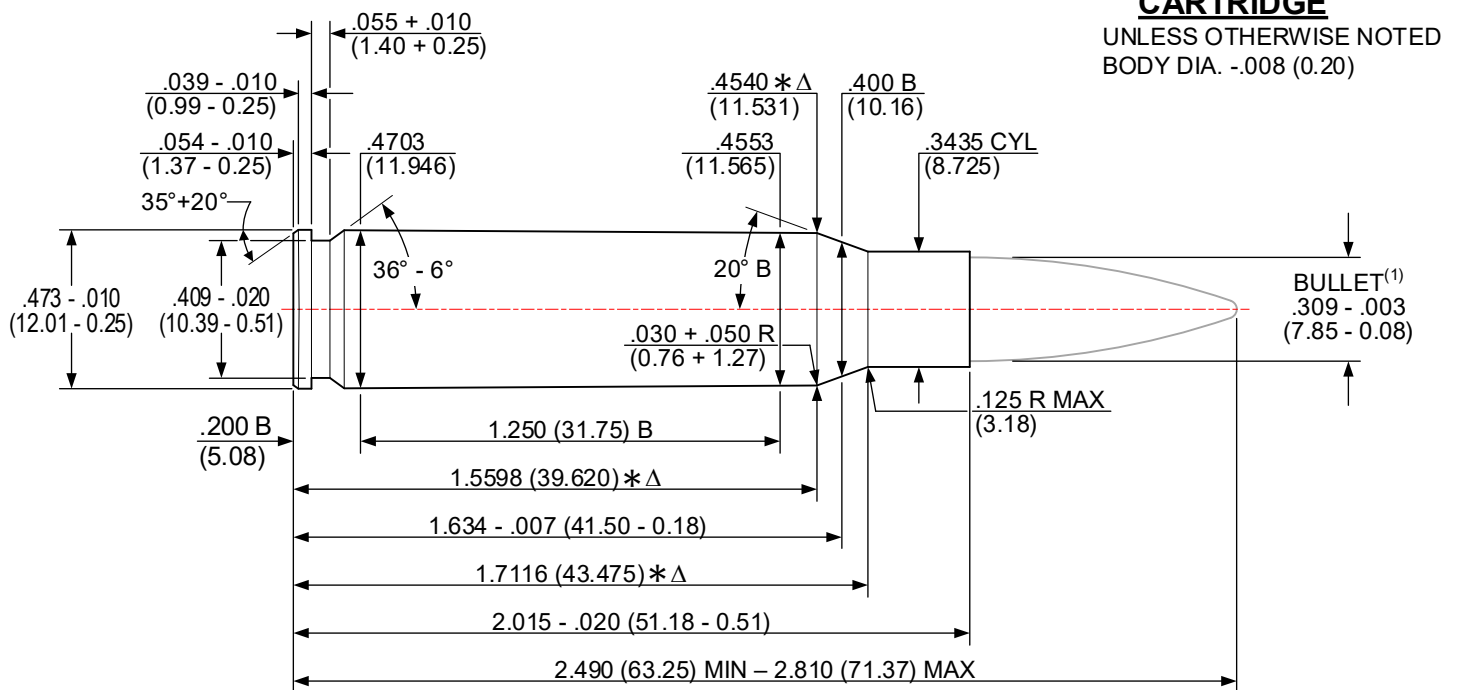

Δ 4 GROOVES TWIST: 12.00 (304.8) R.H. OPTIONAL
 Δ .176+.002 (4.47+0.05) WIDE MINIMUM BORE & GROOVE AREA: .0736 in² (47.483 mm²)

NOTES:

- B = BASIC
- Δ = REFERENCE DIMENSION
- ALL CALCULATIONS APPLY AT MAXIMUM MATERIAL CONDITION (MMC)
- (1) – BULLET PROFILE IS SHOWN FOR ILLUSTRATIVE PURPOSES ONLY
- (XX.XX) = MILLIMETERS
- * = DIMENSIONS ARE TO INTERSECTION OF LINES
- ⊗ = HEAD SPACE DIMENSION

DO NOT SCALE FROM DRAWING

NOTICE: This drawing is subject to change.
 Revisions, if applicable, are available at www.saami.org.

ISSUED: 05/29/1979 **32 WINCHESTER SPECIAL [32 WIN SPL]** REVISED: 02/10/2023

CARTRIDGE

UNLESS OTHERWISE NOTED
 BODY DIA. -.008 (0.20)

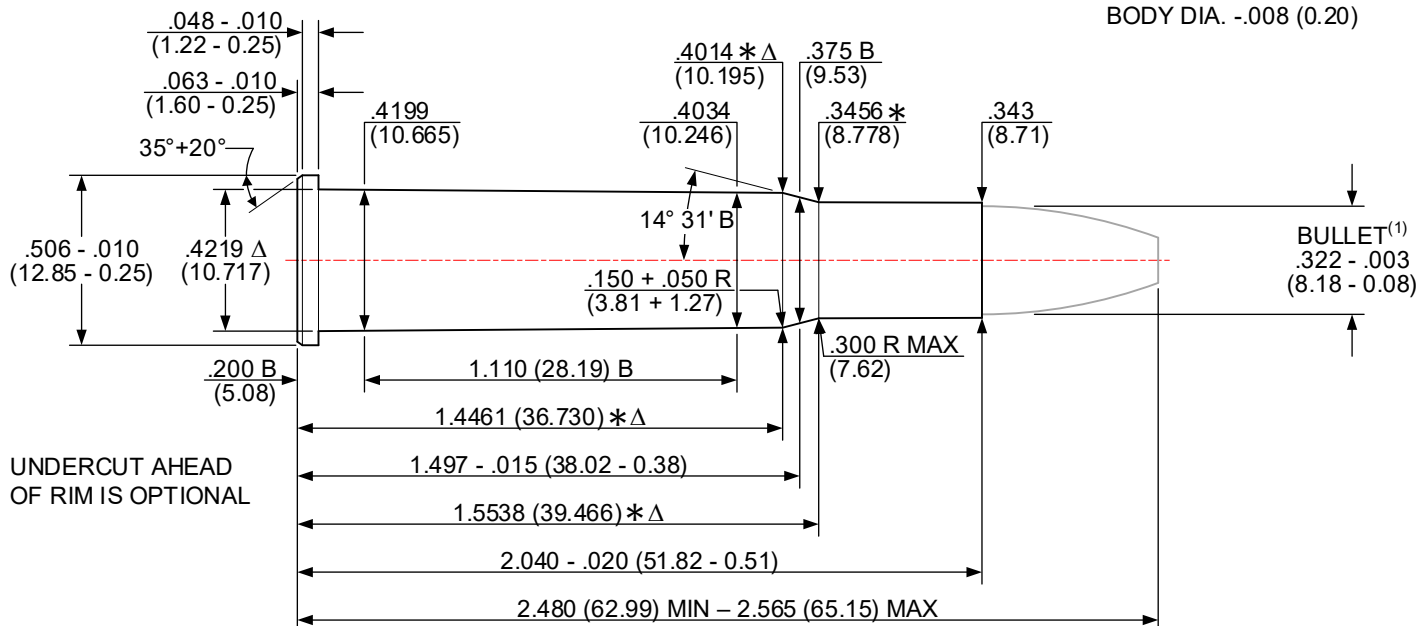

UNDERCUT AHEAD
 OF RIM IS OPTIONAL

BULLET⁽¹⁾
 .322 - .003
 (8.18 - 0.08)

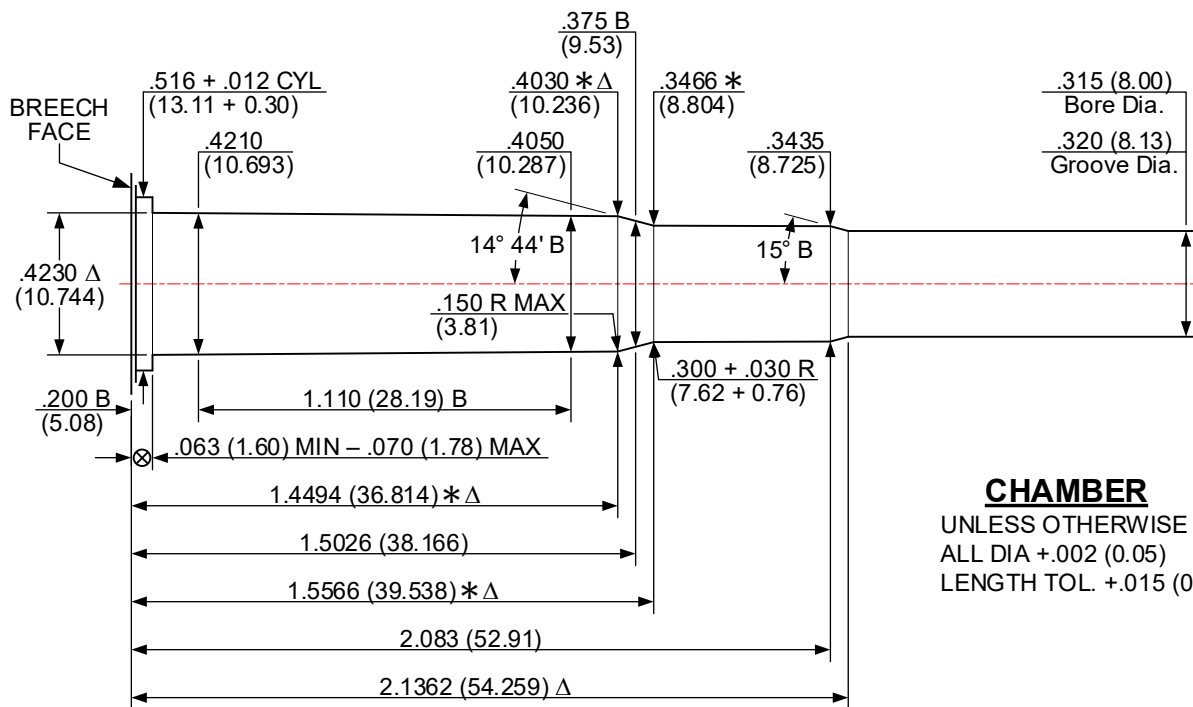

CHAMBER

UNLESS OTHERWISE NOTED
 ALL DIA +.002 (0.05)
 LENGTH TOL. +.015 (0.38)

△ 6 GROOVES TWIST: 16.00 (406.4) R.H. OPTIONAL
 △ .106+.002 (2.69+0.05) WIDE MINIMUM BORE & GROOVE AREA: .0795 in² (51.290 mm²)

NOTES:

- B = BASIC (XX.XX) = MILLIMETERS ⊗ = HEAD SPACE DIMENSION
- △ = REFERENCE DIMENSION * = DIMENSIONS ARE TO INTERSECTION OF LINES
- ALL CALCULATIONS APPLY AT MAXIMUM MATERIAL CONDITION (MMC)
- (1) – BULLET PROFILE IS SHOWN FOR ILLUSTRATIVE PURPOSES ONLY

DO NOT SCALE FROM DRAWING

NOTICE: This drawing is subject to change.
 Revisions, if applicable, are available at www.saami.org.

ISSUED: 05/29/1979 **32-20 WINCHESTER [32-20 WIN]** REVISED: 02/10/2023

CARTRIDGE

UNLESS OTHERWISE NOTED
 BODY DIA. -.008 (0.20)

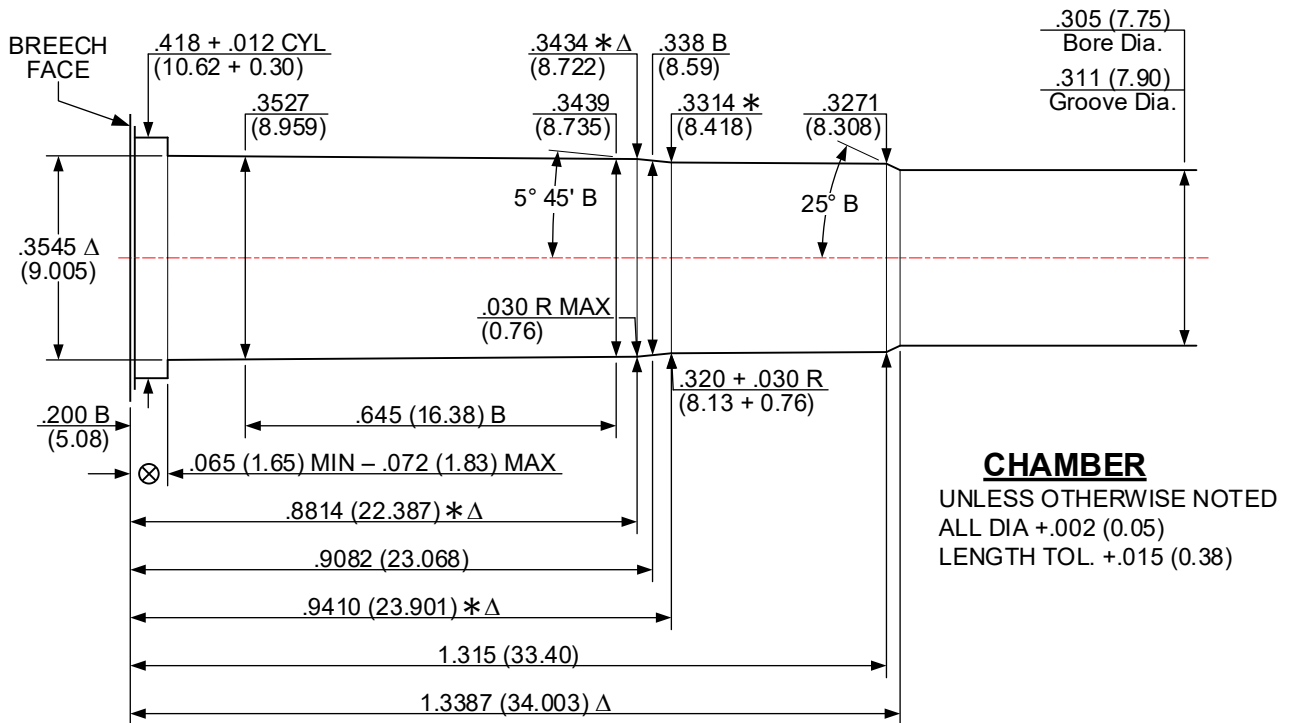
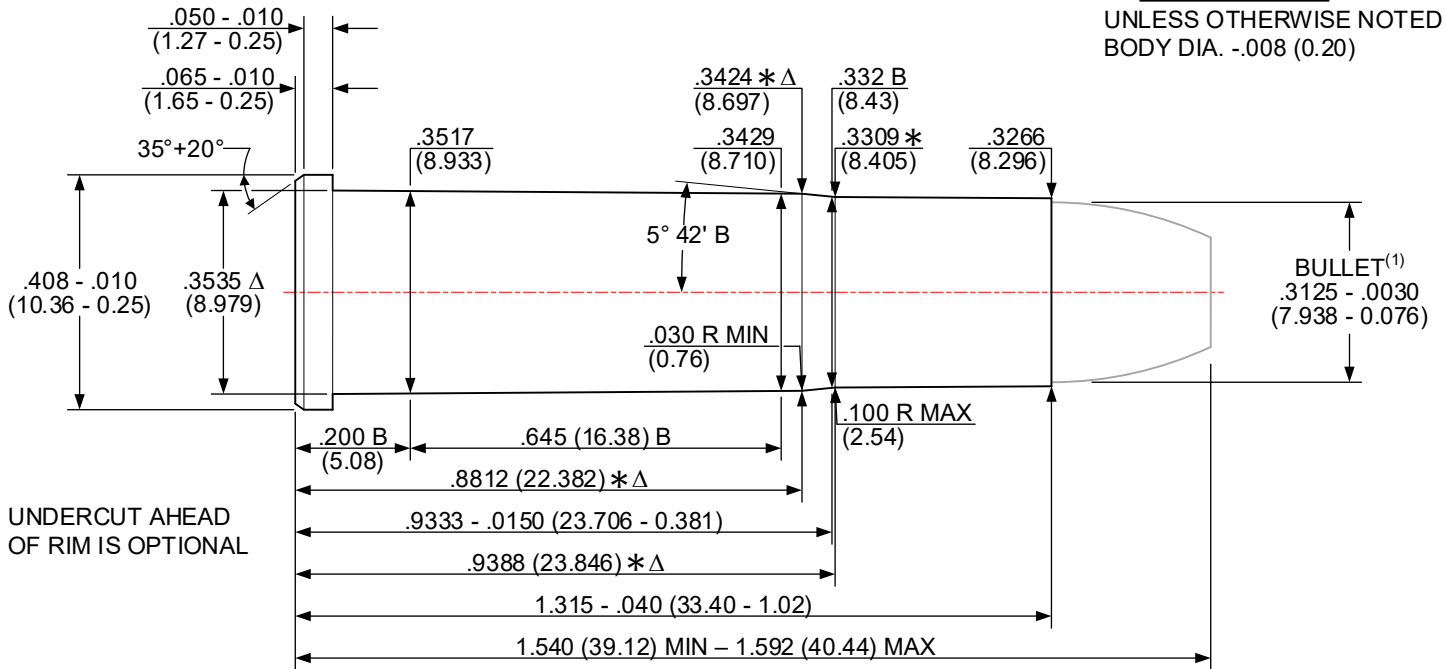

CHAMBER

UNLESS OTHERWISE NOTED
 ALL DIA +.002 (0.05)
 LENGTH TOL. +.015 (0.38)

Δ 6 GROOVES TWIST: 20.00 (508.0) R.H. OPTIONAL
 Δ .0958+.0020 (2.433+0.051) WIDE MINIMUM BORE & GROOVE AREA: .0748 in² (48.257 mm²)

NOTES:

- B = BASIC
- Δ = REFERENCE DIMENSION
- ALL CALCULATIONS APPLY AT MAXIMUM MATERIAL CONDITION (MMC)
- (1) – BULLET PROFILE IS SHOWN FOR ILLUSTRATIVE PURPOSES ONLY
- (XX.XX) = MILLIMETERS
- * = DIMENSIONS ARE TO INTERSECTION OF LINES
- ⊗ = HEAD SPACE DIMENSION

DO NOT SCALE FROM DRAWING

NOTICE: This drawing is subject to change.
 Revisions, if applicable, are available at www.saami.org.

ISSUED: 06/22/2005 **325 WINCHESTER SHORT MAGNUM [325 WSM]** REVISED: 07/27/2022

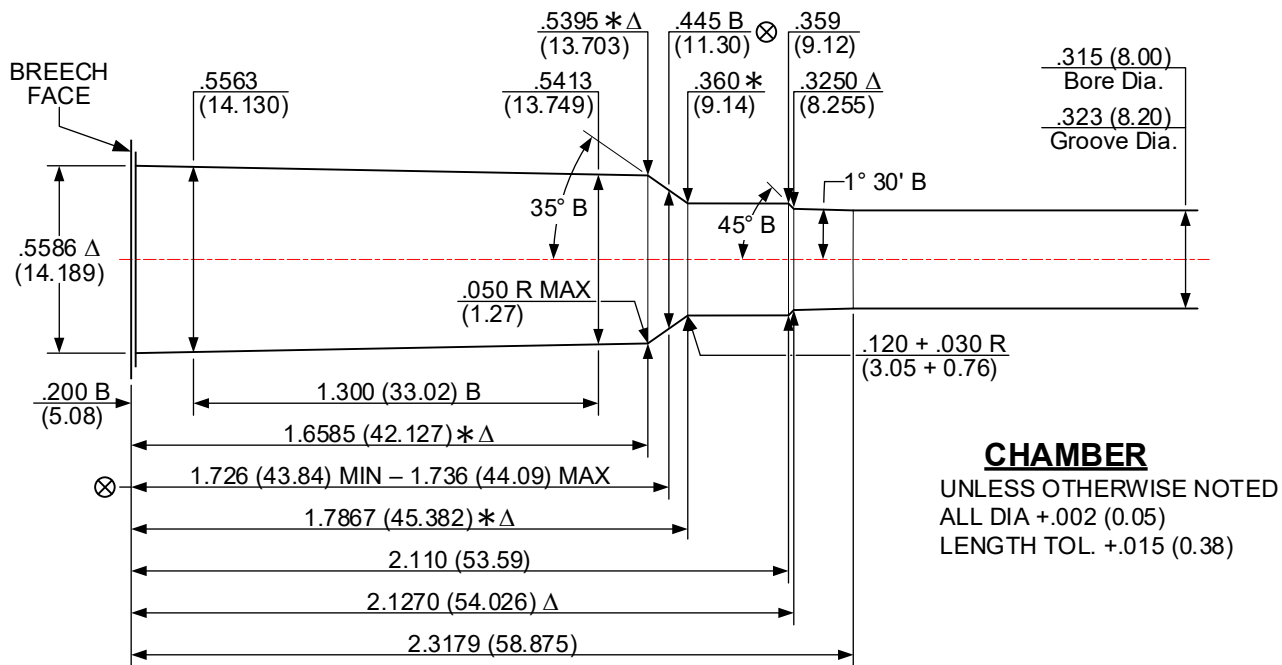
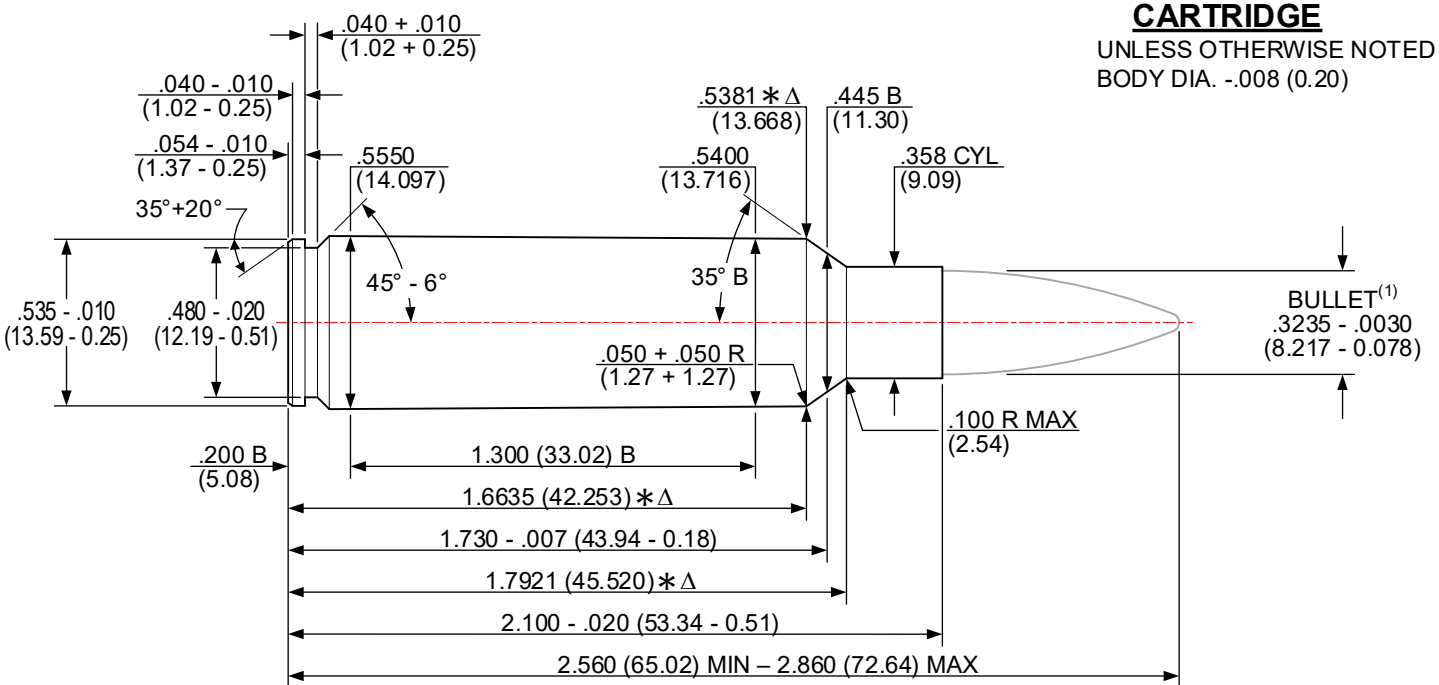

Δ 4 GROOVES TWIST: 10.00 (254.0) R.H. OPTIONAL
 Δ .176+.002 (4.47+0.05) WIDE MINIMUM BORE & GROOVE AREA: .0809 in² (52.193 mm²)

NOTES:

- B = BASIC (XX.XX) = MILLIMETERS ⊗ = HEADSPACE DIMENSION
- Δ = REFERENCE DIMENSION * = DIMENSIONS ARE TO INTERSECTION OF LINES
- ALL CALCULATIONS APPLY AT MAXIMUM MATERIAL CONDITION (MMC)
- (1) – BULLET PROFILE IS SHOWN FOR ILLUSTRATIVE PURPOSES ONLY

DO NOT SCALE FROM DRAWING

NOTICE: This drawing is subject to change.
 Revisions, if applicable, are available at www.saami.org.

ISSUED: 01/19/2015 **33 NOSLER [33 NOSLER]** REVISED: 02/08/2022

CARTRIDGE
 UNLESS OTHERWISE NOTED
 BODY DIA. -.008 (0.20)

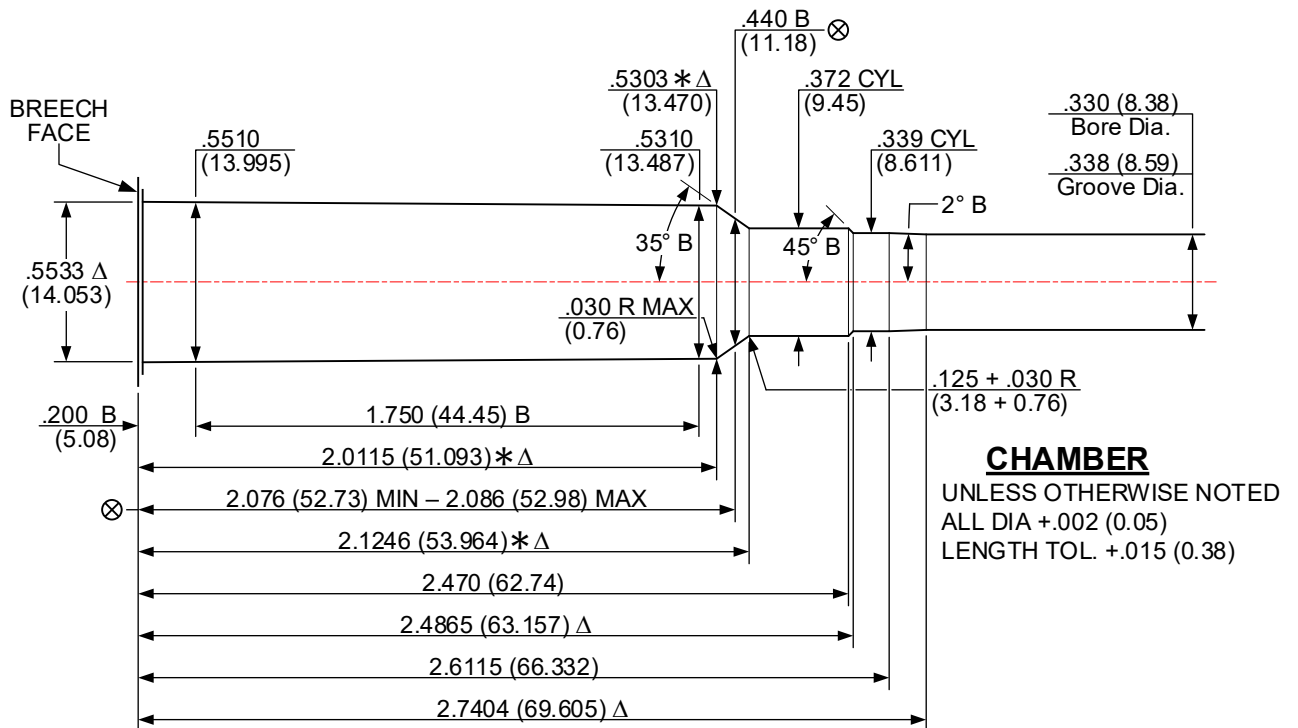
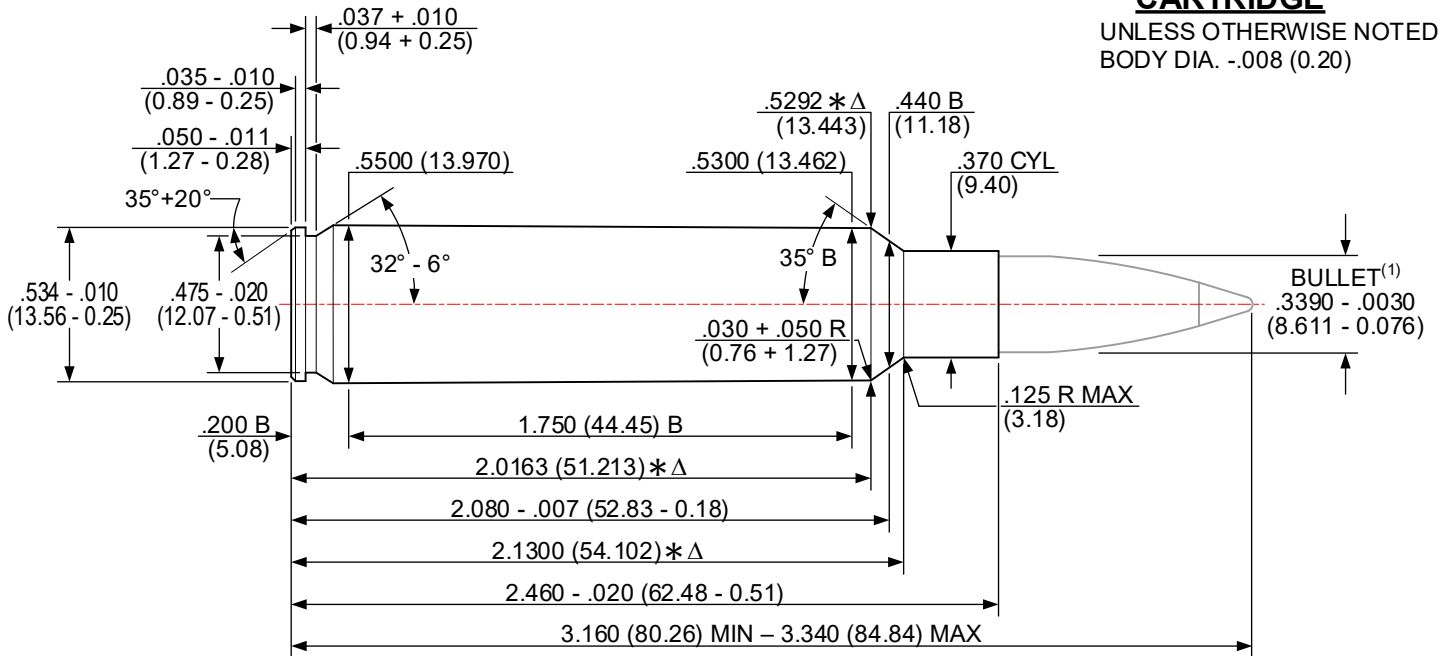

CHAMBER
 UNLESS OTHERWISE NOTED
 ALL DIA +.002 (0.05)
 LENGTH TOL. +.015 (0.38)

Δ 6 GROOVES TWIST: 10.00 (254.0) R.H. OPTIONAL
 Δ .110+.002 (2.79+0.05) WIDE MINIMUM BORE & GROOVE AREA: .0882 in² (56.903 mm²)

NOTES:
 B = BASIC (XX.XX) = MILLIMETERS \otimes = HEADSPACE DIMENSION
 Δ = REFERENCE DIMENSION * = DIMENSIONS ARE TO INTERSECTION OF LINES
 ALL CALCULATIONS APPLY AT MAXIMUM MATERIAL CONDITION (MMC)
 (1) – BULLET PROFILE IS SHOWN FOR ILLUSTRATIVE PURPOSES ONLY

DO NOT SCALE FROM DRAWING

ISSUED: 06/28/2006 **338 FEDERAL [338 FED]** REVISED: 02/08/2022

CARTRIDGE
 UNLESS OTHERWISE NOTED
 BODY DIA. -.008 (0.20)

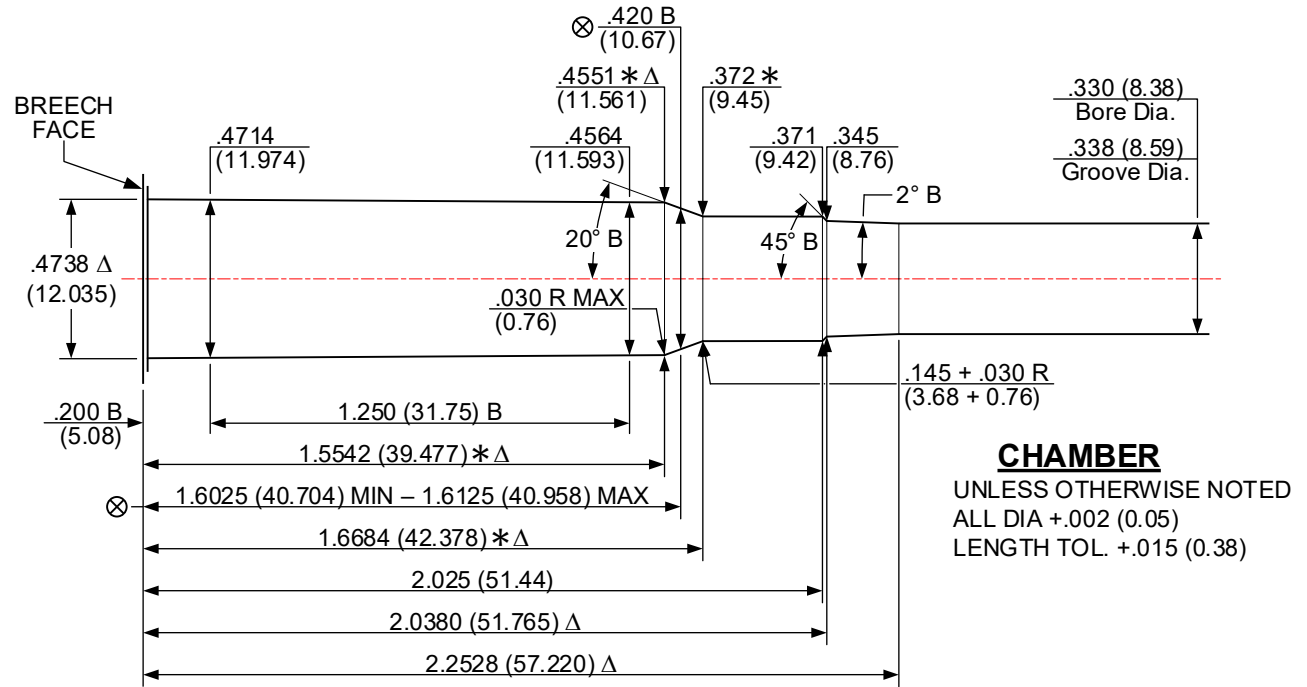
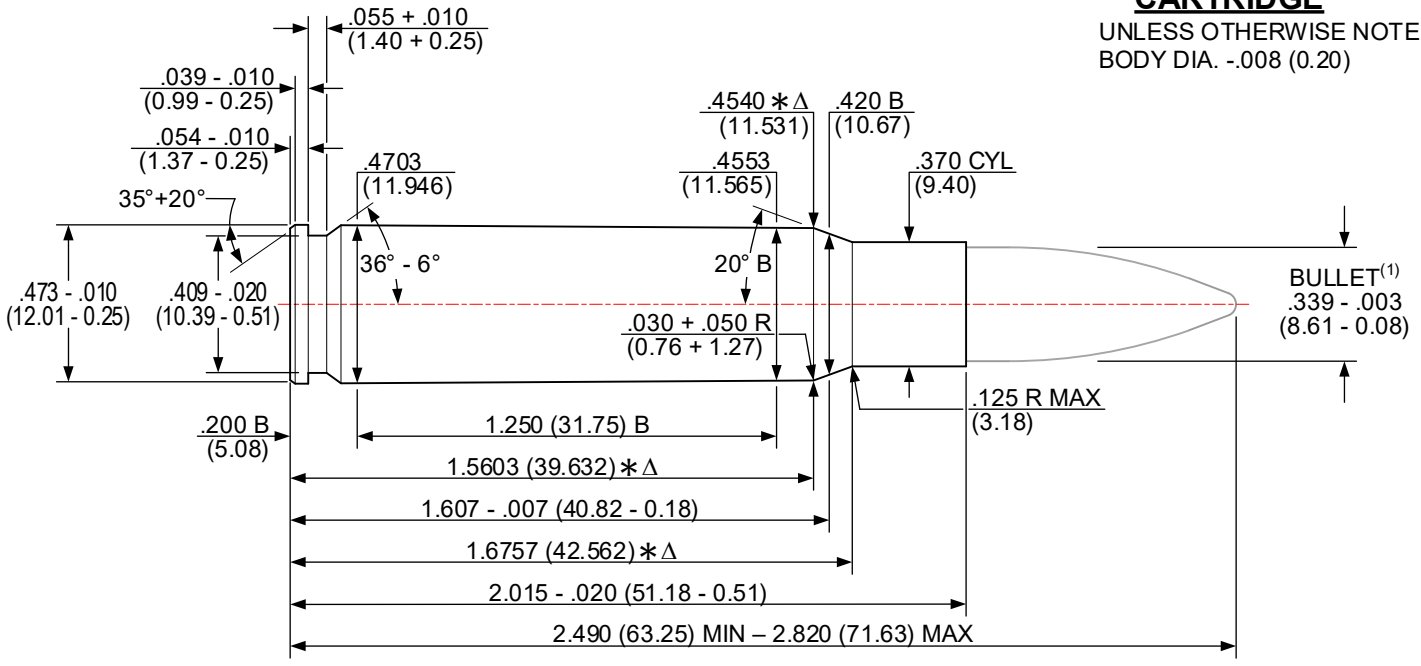

Δ 6 GROOVES TWIST: 10.00 (254.0) R.H. OPTIONAL
 Δ .110+.002 (2.79+0.05) WIDE MINIMUM BORE & GROOVE AREA: .0882 in² (56.903 mm²)

NOTES:
 B = BASIC (XX.XX) = MILLIMETERS ⊗ = HEADSPACE DIMENSION
 Δ = REFERENCE DIMENSION * = DIMENSIONS ARE TO INTERSECTION OF LINES
 ALL CALCULATIONS APPLY AT MAXIMUM MATERIAL CONDITION (MMC)
 (1) – BULLET PROFILE IS SHOWN FOR ILLUSTRATIVE PURPOSES ONLY

DO NOT SCALE FROM DRAWING

NOTICE: This drawing is subject to change.
 Revisions, if applicable, are available at www.saami.org.

ISSUED: 01/14/2013 **338 LAPUA MAGNUM [338 LAPUA MAG]** REVISED: 03/08/2022

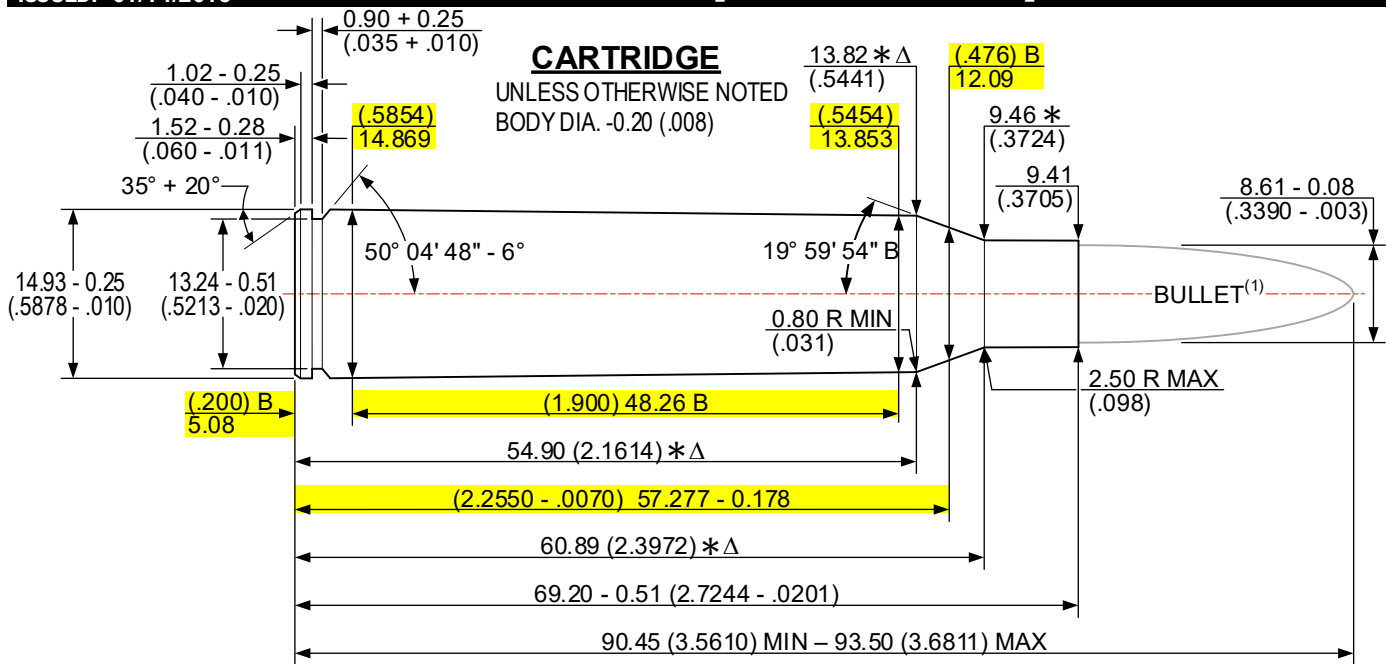

HIGHLIGHTED DIMENSIONS HAVE NO CORRESPONDING C.I.P. ANALOG. THE ENGLISH UNITS FOR THESE ARE THE ORIGINAL VALUES; METRIC VALUES ARE CALCULATED AND ROUNDED.

CHAMBER

UNLESS OTHERWISE NOTED
 ALL DIA +0.05 (.002)
 LENGTH TOL. +0.38 (.015)

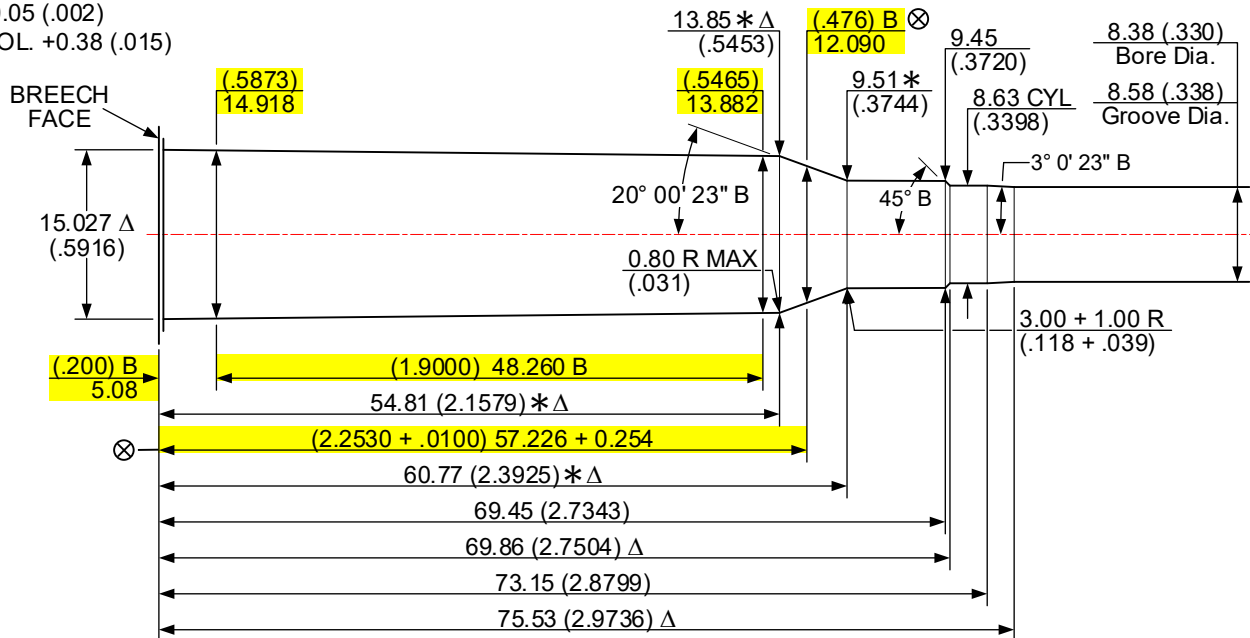

Δ 6 GROOVES
 Δ 2.79 + 0.05 (.1098 + .0020) WIDE

TWIST: 254.0 (10.00) R.H. OPTIONAL
 MINIMUM BORE & GROOVE AREA: 56.860 mm² (.0881 in²)

NOTES:

- B = BASIC
- Δ = REFERENCE DIMENSION
- ALL CALCULATIONS APPLY AT MAXIMUM MATERIAL CONDITION (MMC)
- (1) – BULLET PROFILE IS SHOWN FOR ILLUSTRATIVE PURPOSES ONLY
- (XX.XXX) = INCHES
- * = DIMENSIONS ARE TO INTERSECTION OF LINES
- ⊗ = HEADSPACE DIMENSION

DO NOT SCALE FROM DRAWING

NOTICE: This drawing is subject to change.
 Revisions, if applicable, are available at www.saami.org.

ISSUED: 06/17/2009

338 MARLIN EXPRESS [338 MAR EXP]

REVISED: 07/21/2023

CARTRIDGE

UNLESS OTHERWISE NOTED
 BODY DIA. -.008 (0.20)

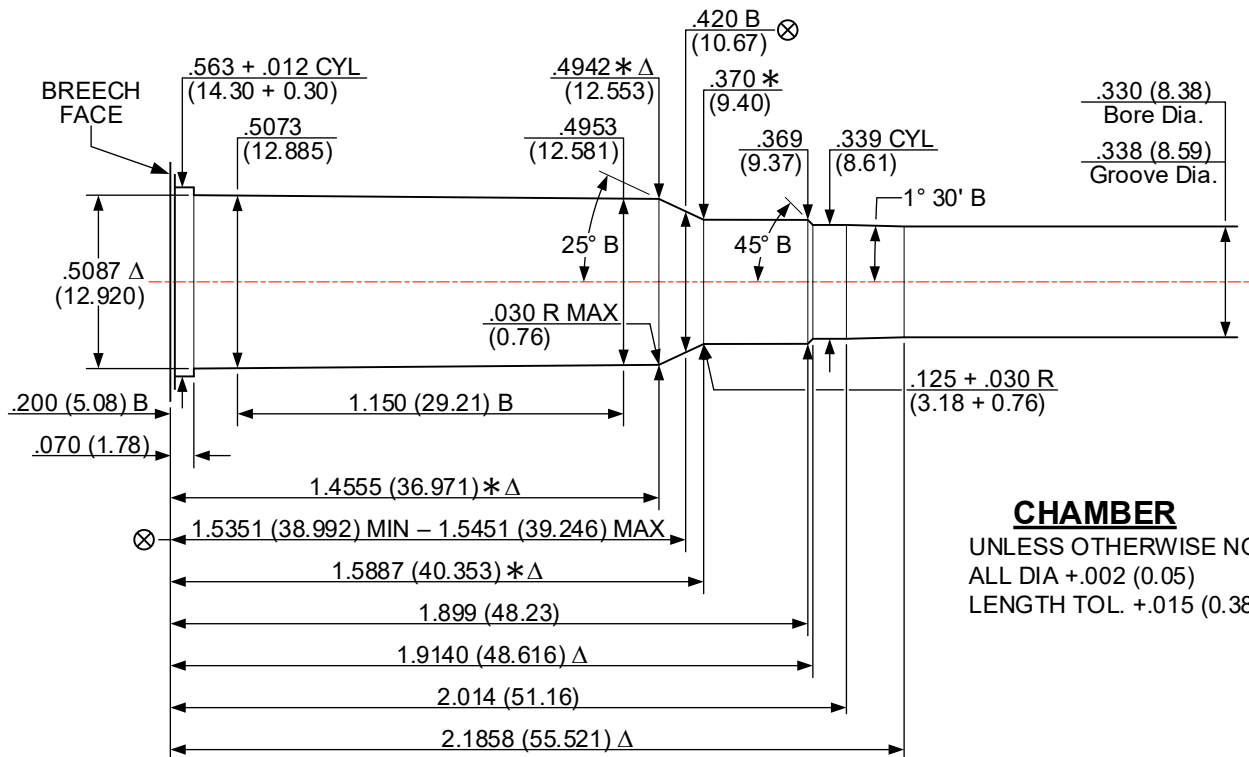
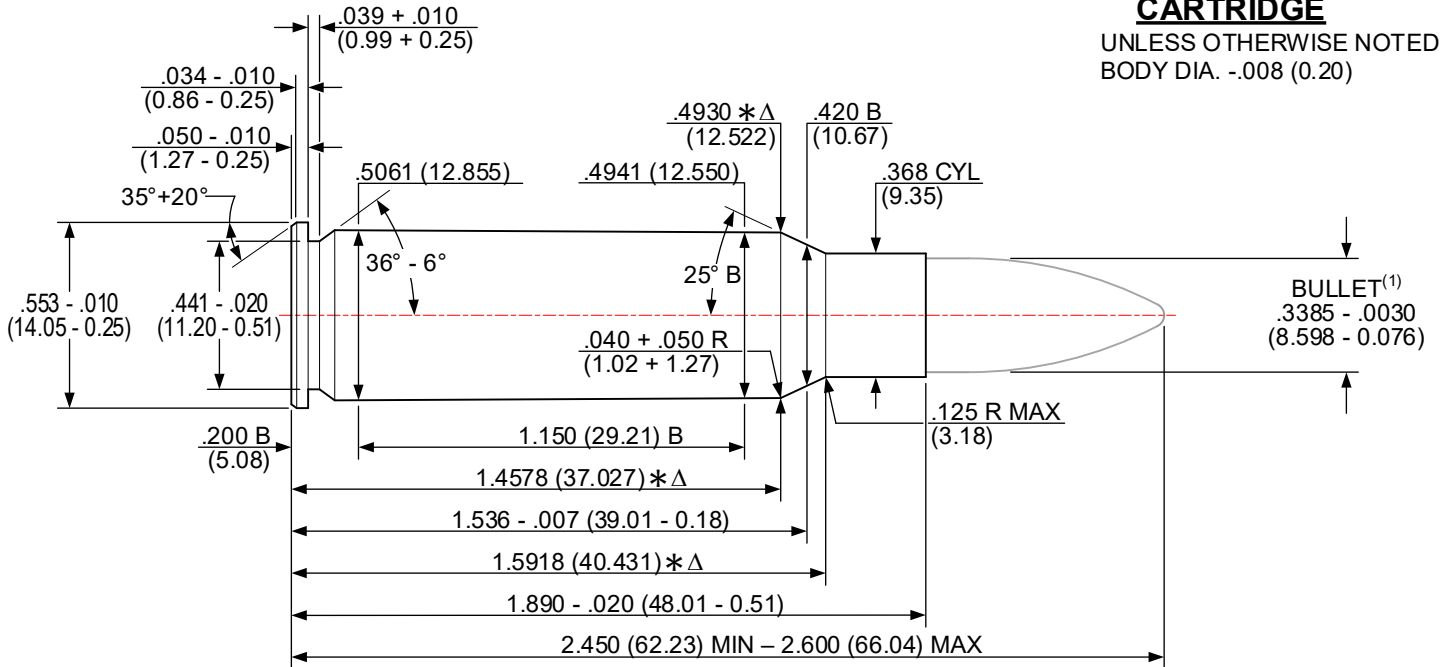

CHAMBER

UNLESS OTHERWISE NOTED
 ALL DIA +.002 (0.05)
 LENGTH TOL. +.015 (0.38)

Δ 6 GROOVES TWIST: 12.00 (304.8) R.H. OPTIONAL
 Δ .110+.002 (2.79+0.05) WIDE MINIMUM BORE & GROOVE AREA: .0882 in² (56.903 mm²)

NOTES:

- B = BASIC
- Δ = REFERENCE DIMENSION
- ALL CALCULATIONS APPLY AT MAXIMUM MATERIAL CONDITION (MMC)
- (1) – BULLET PROFILE IS SHOWN FOR ILLUSTRATIVE PURPOSES ONLY
- (XX.XX) = MILLIMETERS
- * = DIMENSIONS ARE TO INTERSECTION OF LINES
- ⊗ = HEADSPACE DIMENSION

DO NOT SCALE FROM DRAWING

ISSUED: 09/24/2020 **338 NORMA MAGNUM [338 NM]** REVISED: 10/11/2024

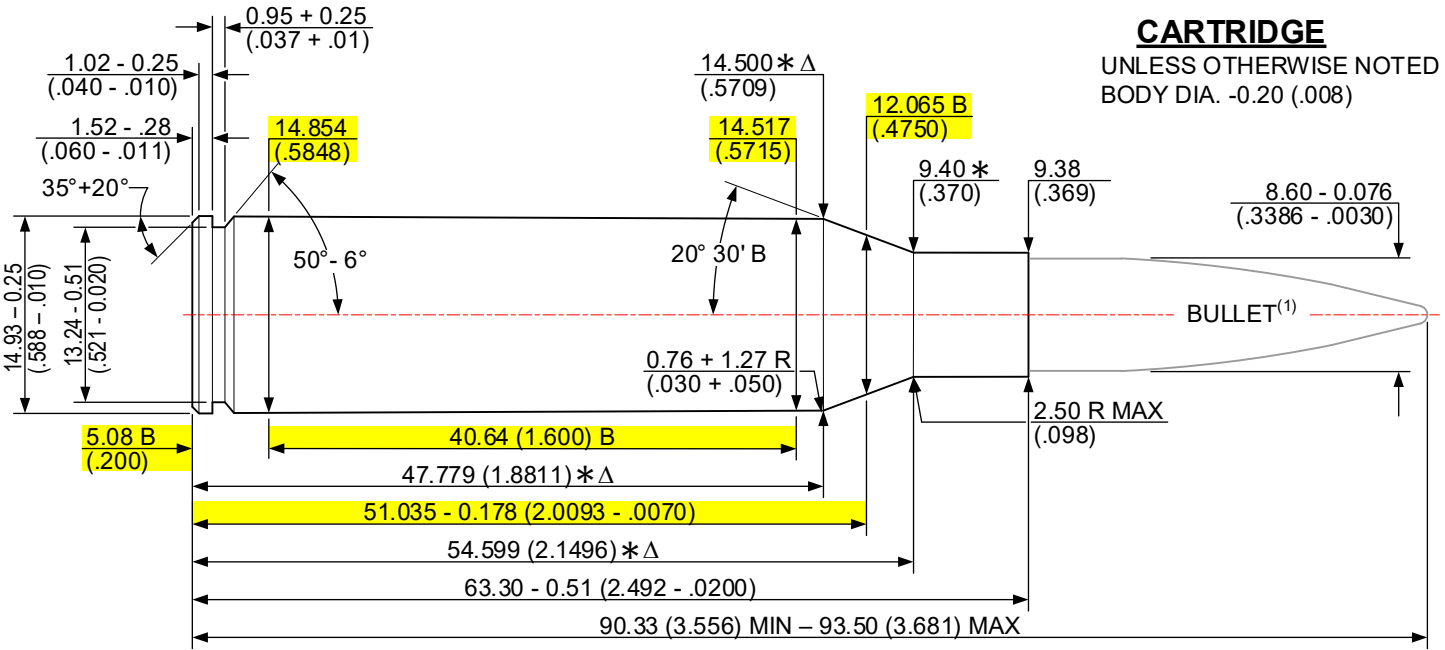

CARTRIDGE
 UNLESS OTHERWISE NOTED
 BODY DIA. -0.20 (.008)

HIGHLIGHTED DIMENSIONS HAVE NO CORRESPONDING C.I.P. ANALOG. THE METRIC UNITS FOR THESE ARE THE ORIGINAL VALUES; U.S. CUSTOMARY VALUES ARE CALCULATED AND ROUNDED.

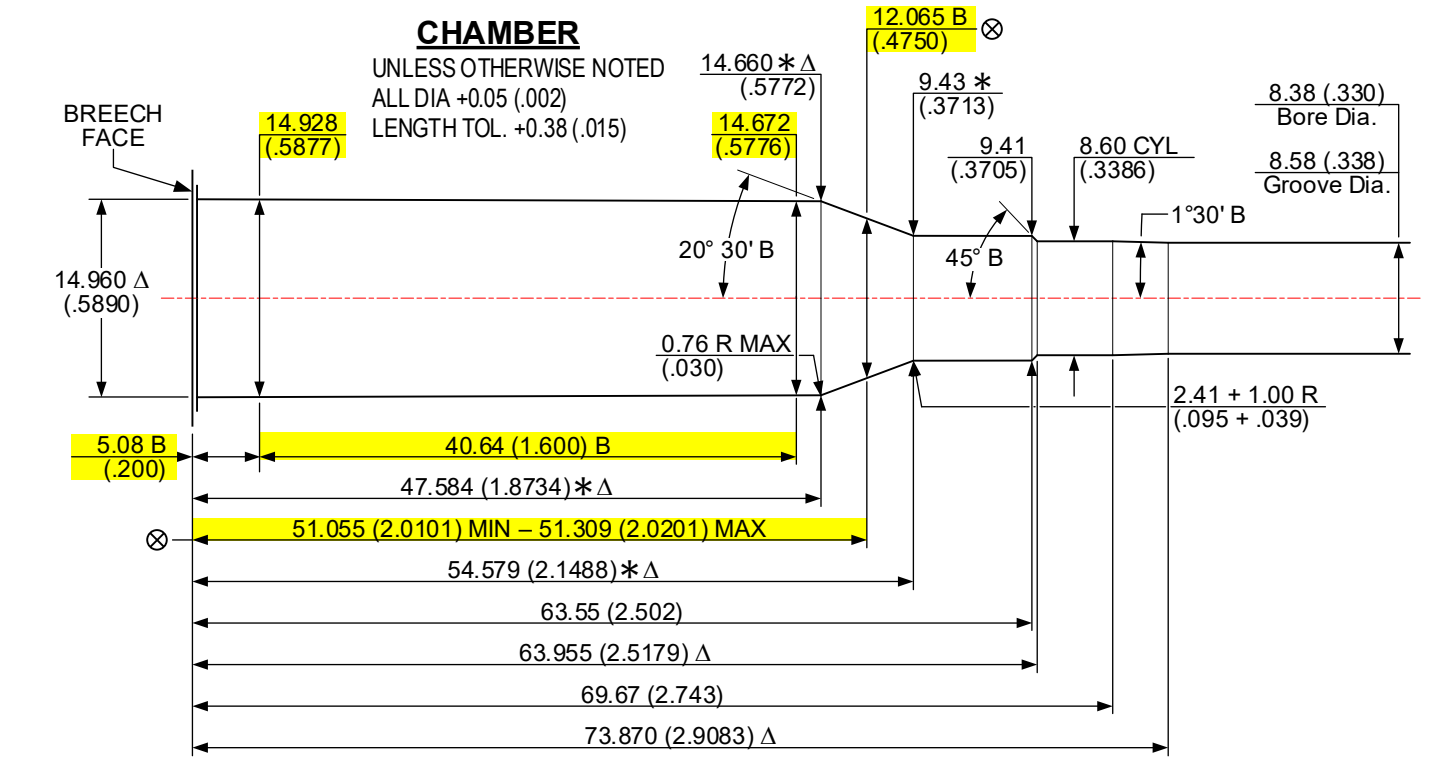

CHAMBER
 UNLESS OTHERWISE NOTED
 ALL DIA +0.05 (.002)
 LENGTH TOL. +0.38 (.015)

Δ 6 GROOVES TWIST: 235.0 (9.25) R.H. OPTIONAL
 Δ 2.79+0.05 (.1098+.0020) WIDE MINIMUM BORE & GROOVE AREA: 56.860 mm² (.0881 in²)

NOTES:
 B = BASIC (XX.XX) = INCHES ⊗ = HEADSPACE DIMENSION
 Δ = REFERENCE DIMENSION * = DIMENSIONS ARE TO INTERSECTION OF LINES
 ALL CALCULATIONS APPLY AT MAXIMUM MATERIAL CONDITION (MMC)
 (1) – BULLET PROFILE IS SHOWN FOR ILLUSTRATIVE PURPOSES ONLY

DO NOT SCALE FROM DRAWING

METRIC ORIGIN METRIC ORIGIN METRIC ORIGIN METRIC ORIGIN

NOTICE: This drawing is subject to change.
 Revisions, if applicable, are available at www.saami.org.

ISSUED: 06/08/1999 **338 REMINGTON ULTRA MAGNUM [338 REM ULTRA MAG]** REVISED: 02/11/2022

CARTRIDGE

UNLESS OTHERWISE NOTED
 BODY DIA. -.008 (0.20)

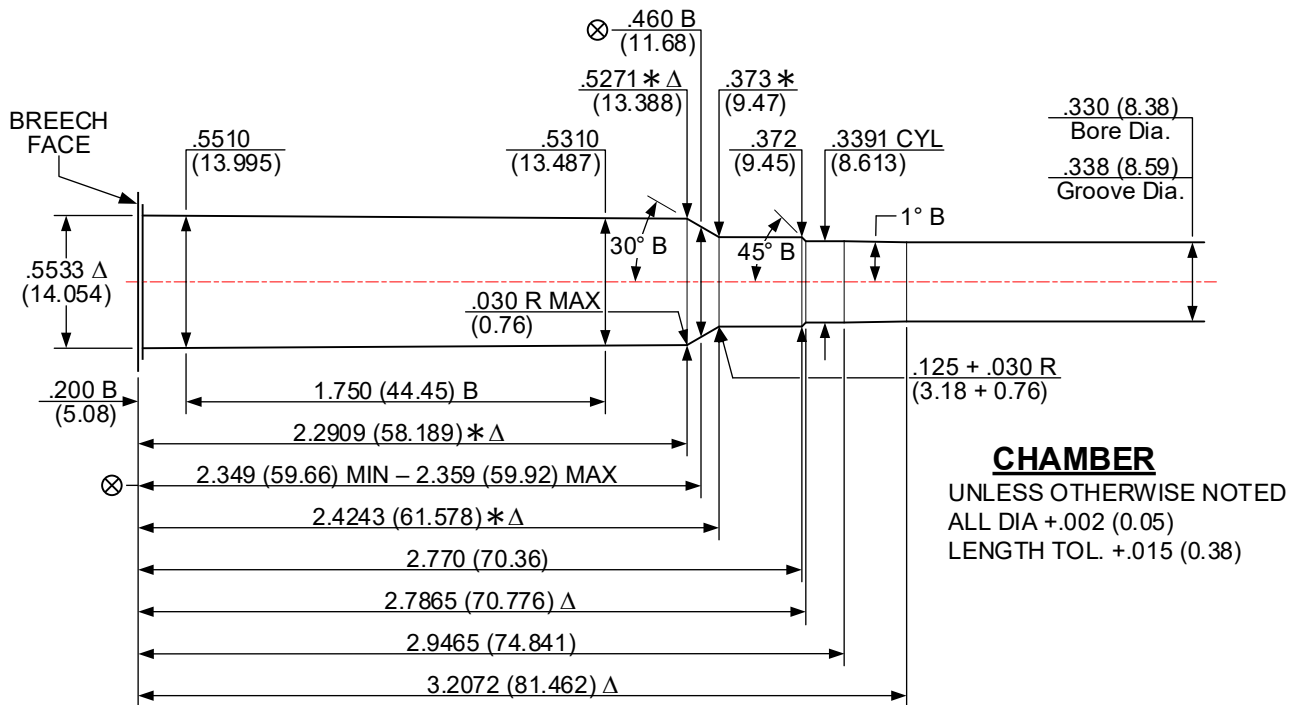
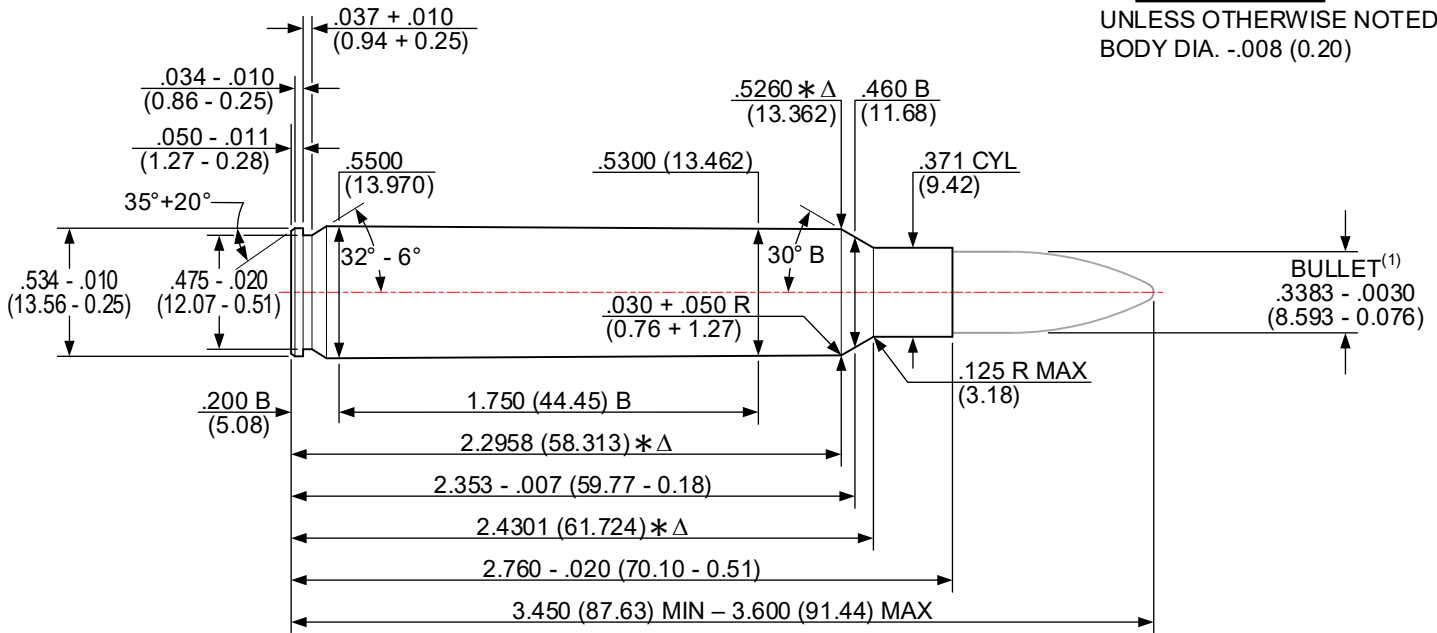

CHAMBER

UNLESS OTHERWISE NOTED
 ALL DIA +.002 (0.05)
 LENGTH TOL. +.015 (0.38)

△ 6 GROOVES TWIST: 10.00 (254.0) R.H. OPTIONAL
 △ .110+.002 (2.79+0.05) WIDE MINIMUM BORE & GROOVE AREA: .0882 in² (56.903 mm²)

NOTES:

- B = BASIC
- △ = REFERENCE DIMENSION
- ALL CALCULATIONS APPLY AT MAXIMUM MATERIAL CONDITION (MMC)
- (1) – BULLET PROFILE IS SHOWN FOR ILLUSTRATIVE PURPOSES ONLY
- (XX.XX) = MILLIMETERS
- * = DIMENSIONS ARE TO INTERSECTION OF LINES
- ⊗ = HEADSPACE DIMENSION

DO NOT SCALE FROM DRAWING

NOTICE: This drawing is subject to change.
 Revisions, if applicable, are available at www.saami.org.

ISSUED: 12/30/2008 **338 RUGER COMPACT MAGNUM [338 RCM]** REVISED: 02/11/2022

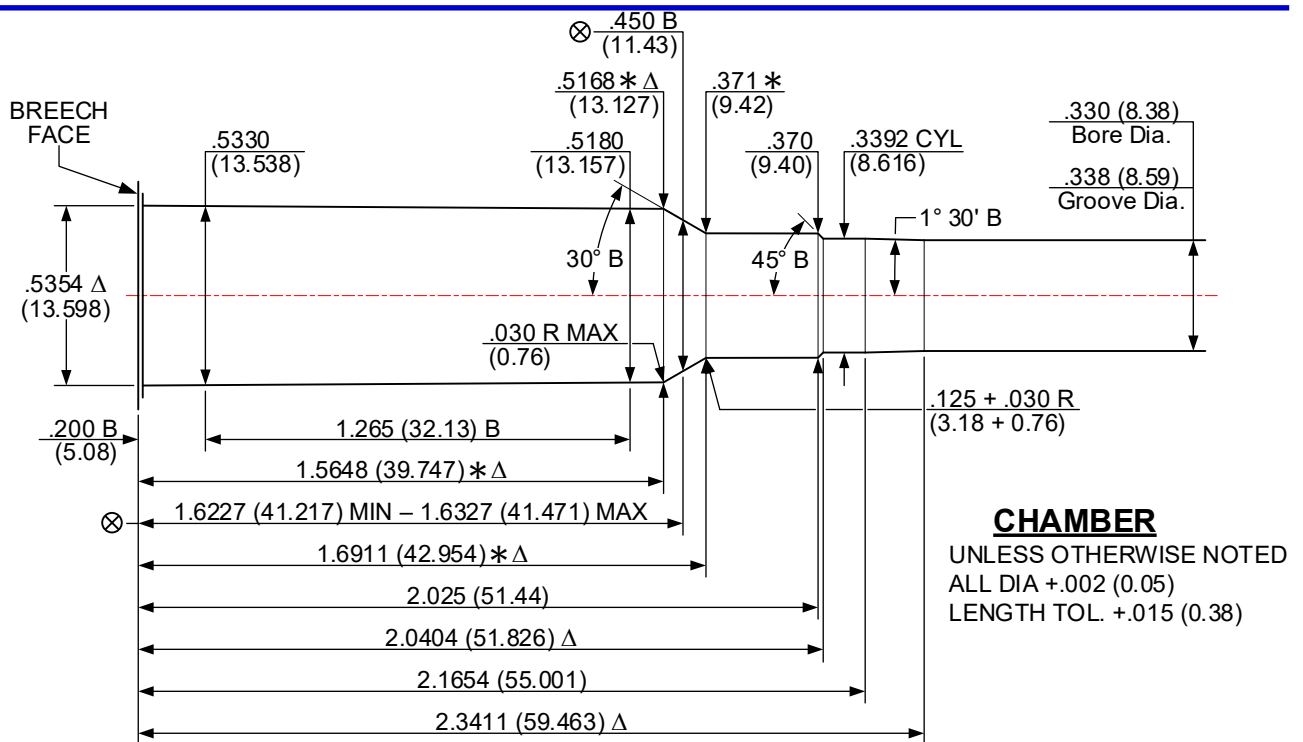
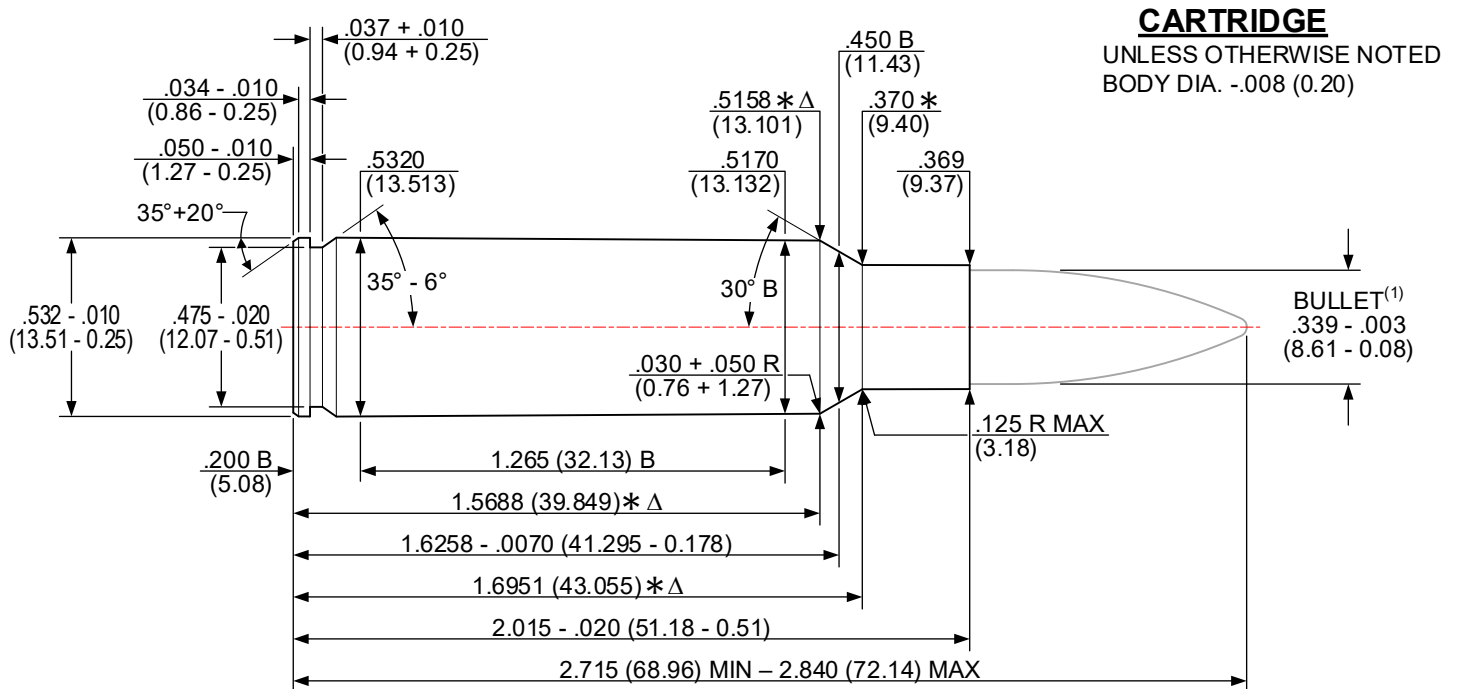

△ 6 GROOVES TWIST: 10.00 (254.0) R.H. OPTIONAL
 △ .110+.002 (2.79+0.05) WIDE MINIMUM BORE & GROOVE AREA: .0882 in² (56.903 mm²)

NOTES:

- B = BASIC (XX.XX) = MILLIMETERS ⊗ = HEADSPACE DIMENSION
- △ = REFERENCE DIMENSION * = DIMENSIONS ARE TO INTERSECTION OF LINES
- ALL CALCULATIONS APPLY AT MAXIMUM MATERIAL CONDITION (MMC)
- (1) – BULLET PROFILE IS SHOWN FOR ILLUSTRATIVE PURPOSES ONLY

DO NOT SCALE FROM DRAWING

NOTICE: This drawing is subject to change.
 Revisions, if applicable, are available at www.saami.org.

338 WEATHERBY REBATED PRECISION MAGNUM [338 WBYP RPM]

ISSUED: 01/16/2022

REVISED: - / - / - - -

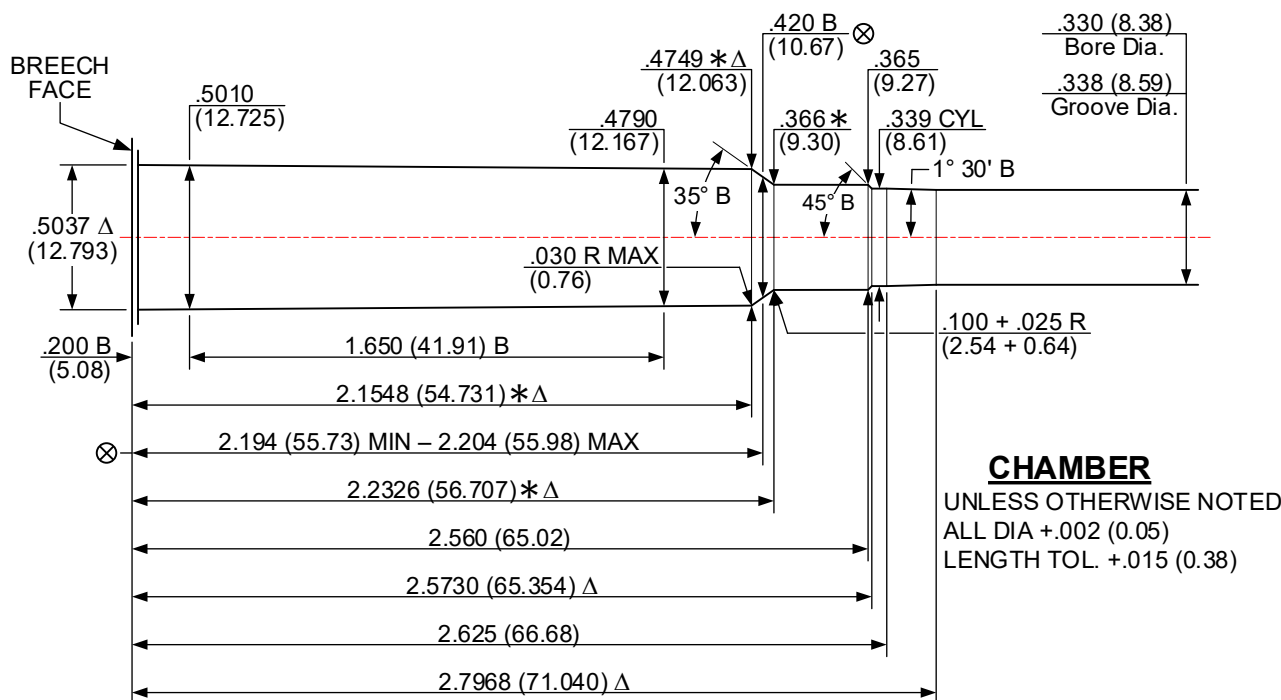
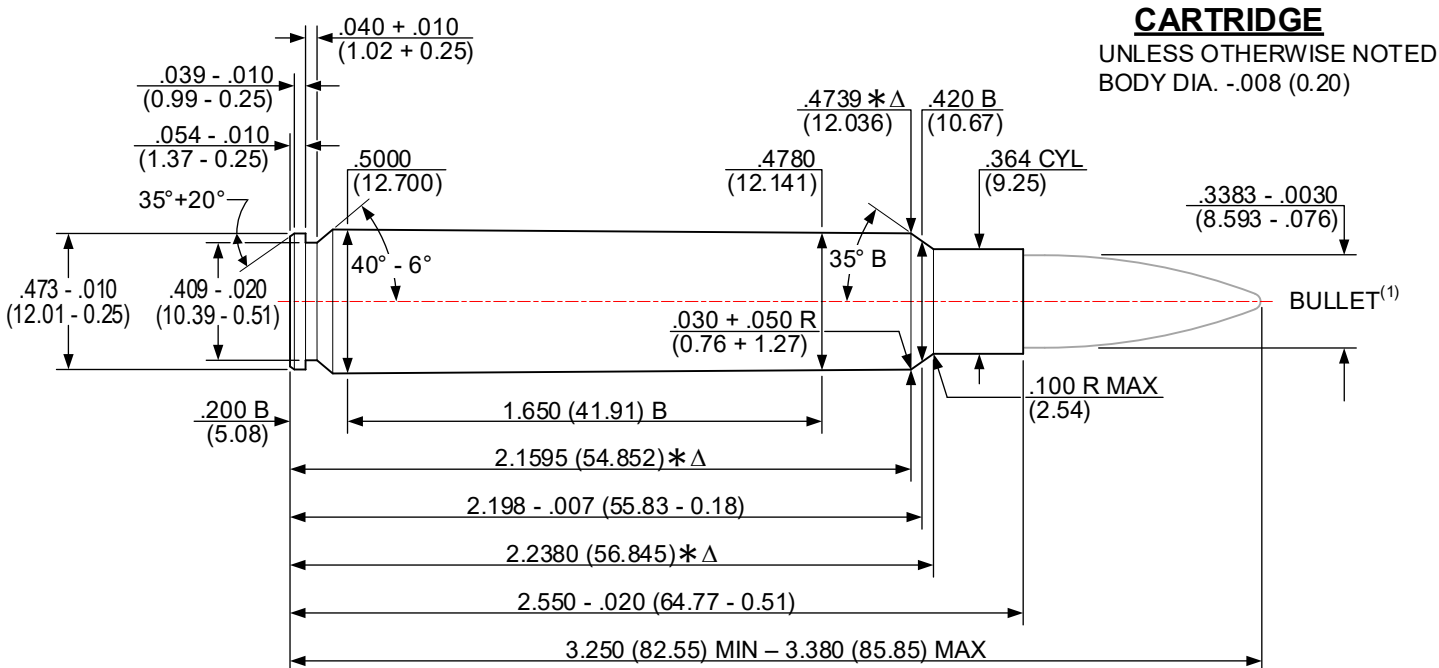

Δ 6 GROOVES TWIST: 10.00 (254.0) R.H. OPTIONAL
 Δ .126+.002 (3.73+0.05) WIDE MINIMUM BORE & GROOVE AREA: .0886 in² (57.161 mm²)

NOTES:

- B = BASIC
- Δ = REFERENCE DIMENSION
- ALL CALCULATIONS APPLY AT MAXIMUM MATERIAL CONDITION (MMC)
- (1) – BULLET PROFILE IS SHOWN FOR ILLUSTRATIVE PURPOSES ONLY
- (XX.XXX) = MILLIMETERS
- * = DIMENSIONS ARE TO INTERSECTION OF LINES
- ⊗ = HEADSPACE DIMENSION

DO NOT SCALE FROM DRAWING

NOTICE: This drawing is subject to change.
 Revisions, if applicable, are available at www.saami.org.

ISSUED: 04/21/1980 **338 WINCHESTER MAGNUM [338 WIN MAG]** **REVISED: 02/15/2022**

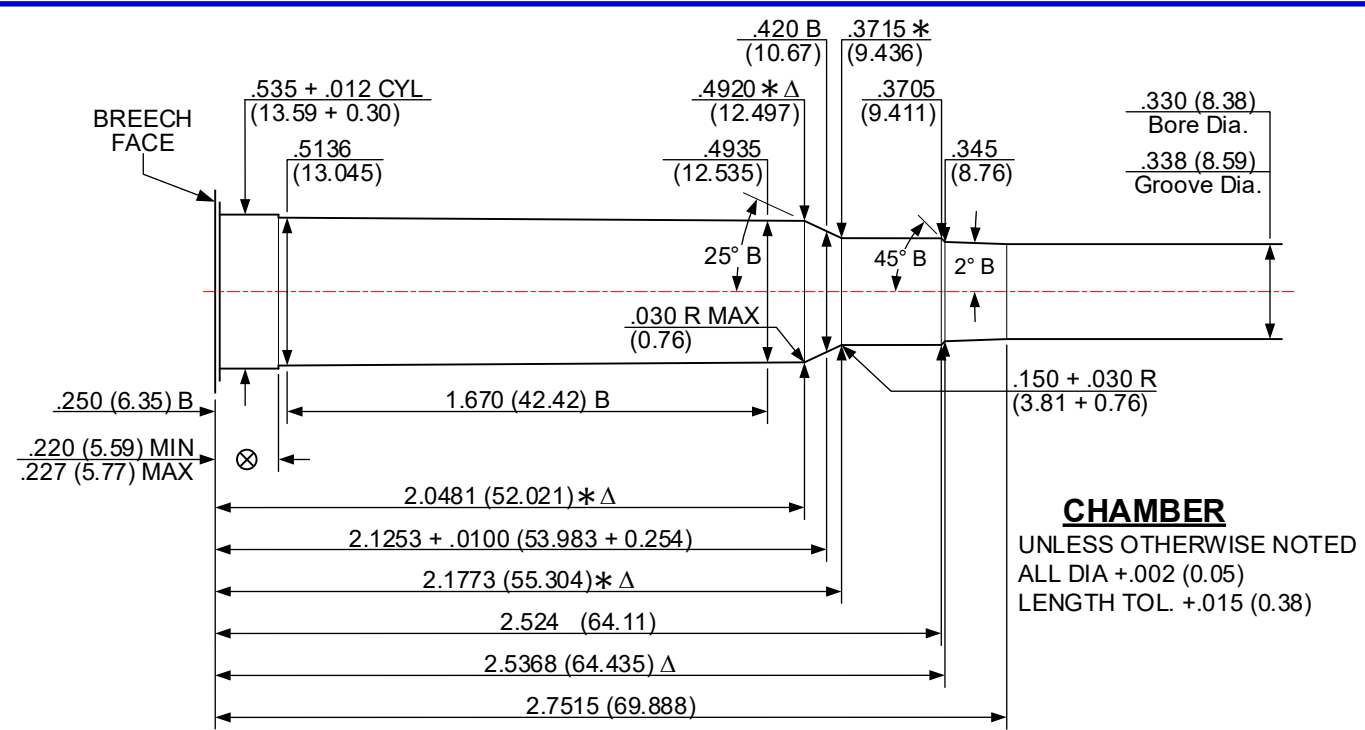
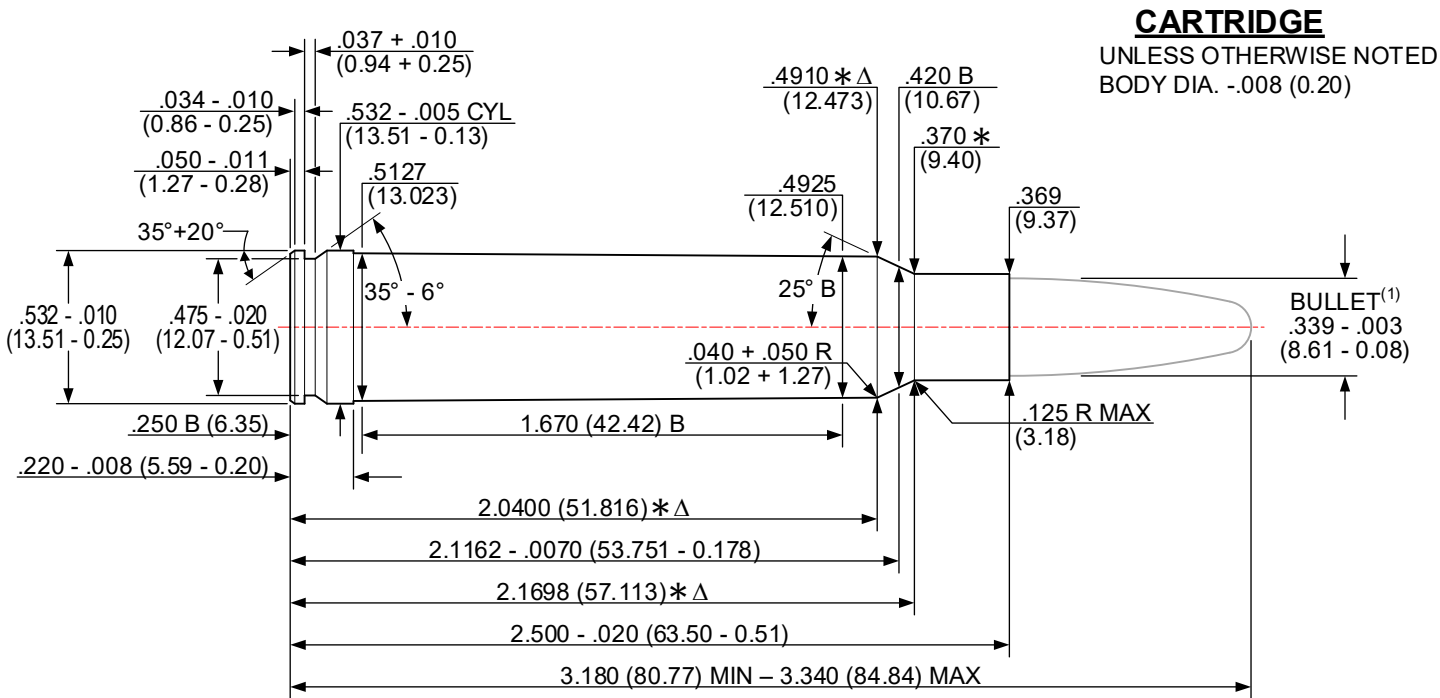

Δ 6 GROOVES TWIST: 10.00 (254.0) R.H. OPTIONAL
 Δ .110+.002 (2.79+0.05) WIDE MINIMUM BORE & GROOVE AREA: .0882 in² (56.903 mm²)

NOTES:
 B = BASIC (XX.XX) = MILLIMETERS ⊗ = HEADSPACE DIMENSION
 Δ = REFERENCE DIMENSION * = DIMENSIONS ARE TO INTERSECTION OF LINES
 ALL CALCULATIONS APPLY AT MAXIMUM MATERIAL CONDITION (MMC)
 (1) – BULLET PROFILE IS SHOWN FOR ILLUSTRATIVE PURPOSES ONLY

DO NOT SCALE FROM DRAWING

ISSUED: 01/12/1994 **340 WEATHERBY MAGNUM [340 WBV MAG]** REVISED: 01/21/2024

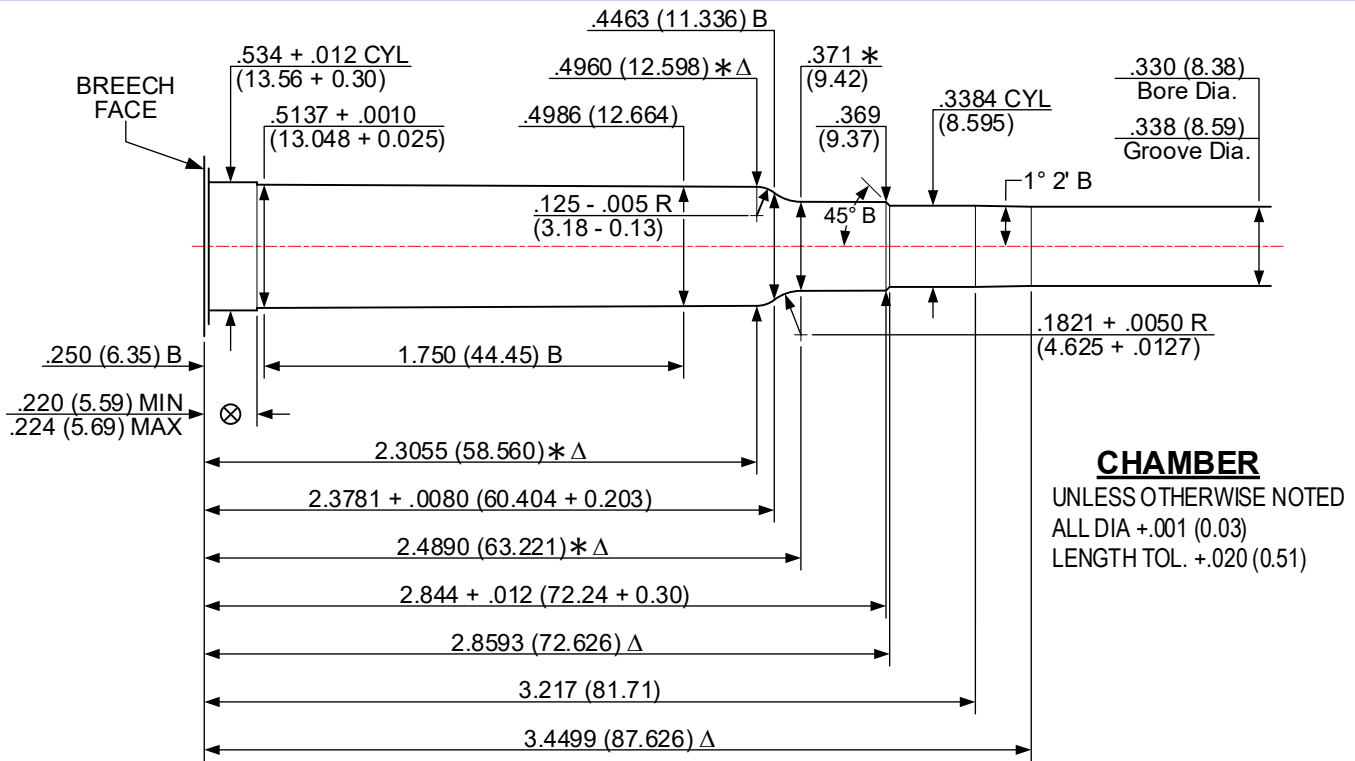
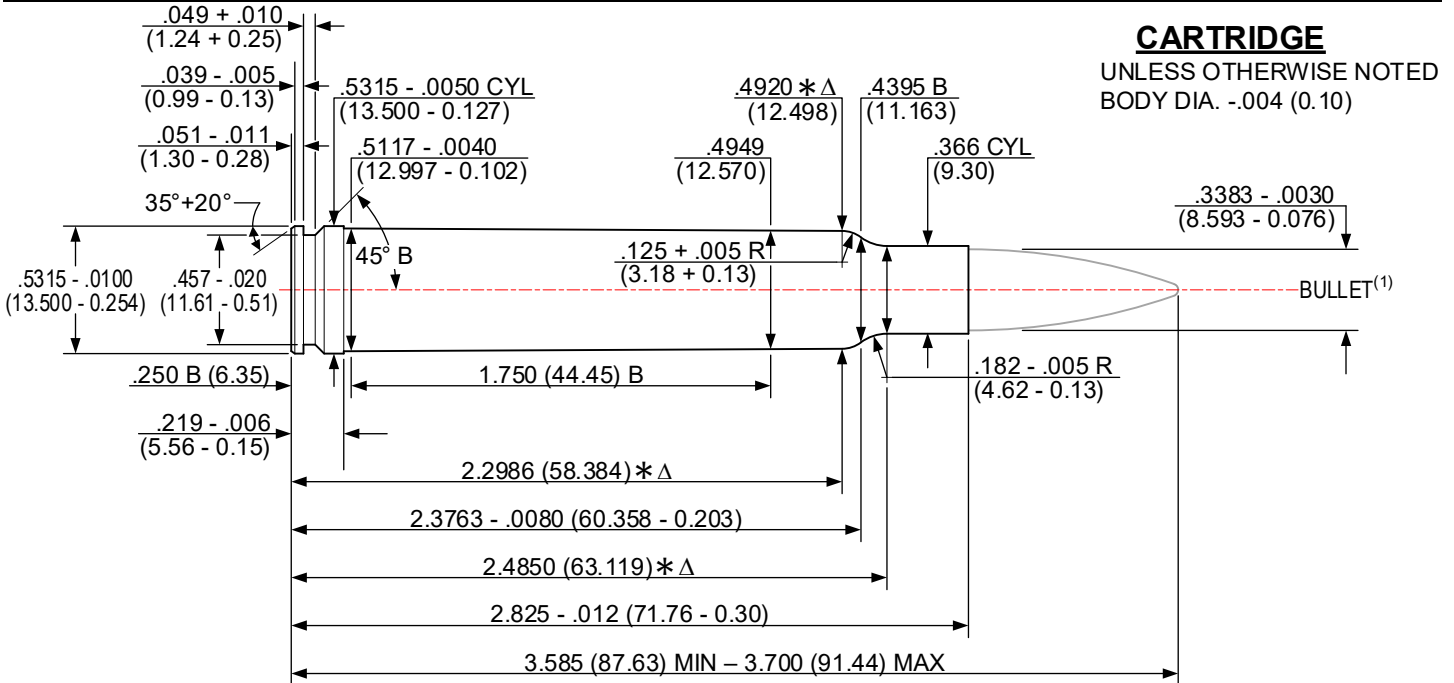

Δ 6 GROOVES TWIST: 10.00 (254.0) R.H. OPTIONAL
 Δ .126+.002 (3.20+0.05) WIDE MINIMUM BORE & GROOVE AREA: .0886 in² (57.161 mm²)

NOTE:
 B = BASIC (XX.XX) = MILLIMETERS ⊗ = HEADSPACE DIMENSION
 Δ = REFERENCE DIMENSION * = DIMENSIONS ARE TO INTERSECTION OF LINES
 ALL CALCULATIONS APPLY AT MAXIMUM MATERIAL CONDITION (MMC)
 (1) – BULLET PROFILE IS SHOWN FOR ILLUSTRATIVE PURPOSES ONLY

DO NOT SCALE FROM DRAWING

NOTICE: This drawing is subject to change.
 Revisions, if applicable, are available at www.saami.org.

ISSUED: 05/29/1979

348 WINCHESTER [348 WIN]

REVISED: 10/05/2023

CARTRIDGE

UNLESS OTHERWISE NOTED
 BODY DIA. -.008 (0.20)

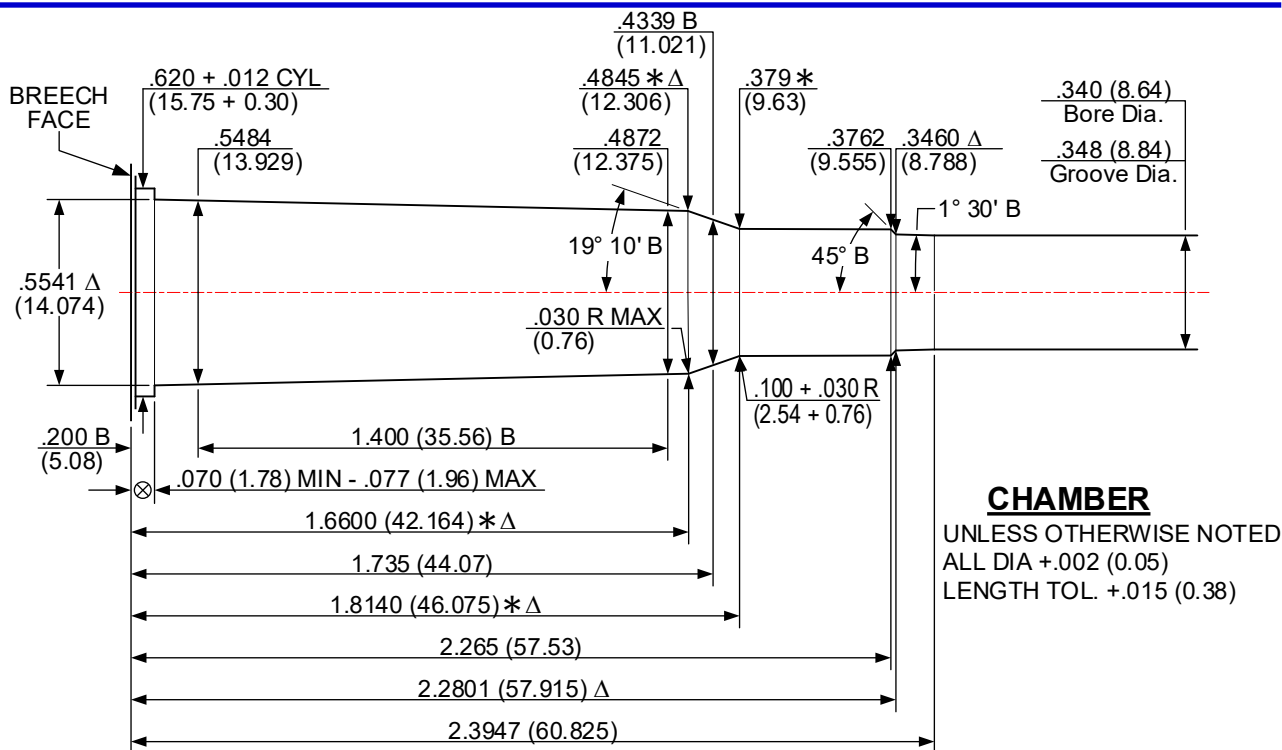
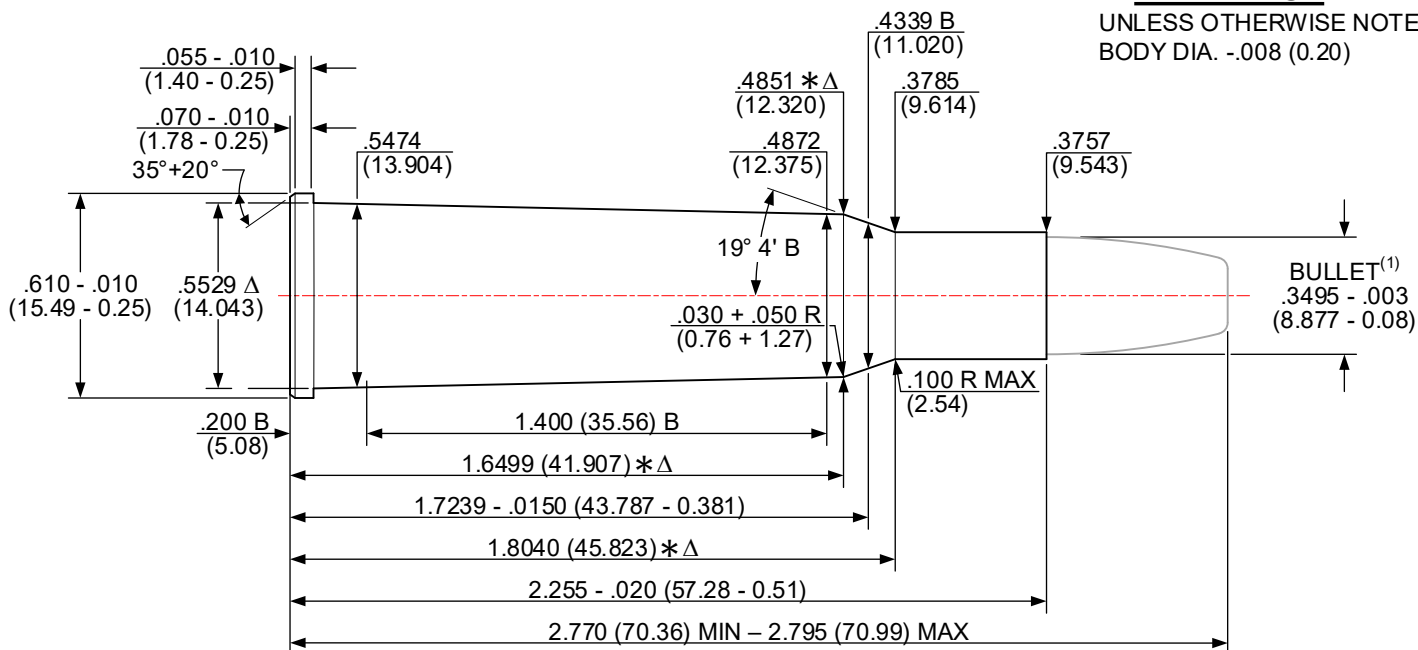

Δ 6 GROOVES

TWIST: 12.00 (304.8) R.H. OPTIONAL

Δ .120+.002 (3.05+0.05) WIDE

MINIMUM BORE & GROOVE AREA: .0937 in² (60.451 mm²)

NOTES:

B = BASIC

(XX.XX) = MILLIMETERS

⊗ = HEAD SPACE DIMENSION

Δ = REFERENCE DIMENSION

* = DIMENSIONS ARE TO INTERSECTION OF LINES

ALL CALCULATIONS APPLY AT MAXIMUM MATERIAL CONDITION (MMC)

(1) – BULLET PROFILE IS SHOWN FOR ILLUSTRATIVE PURPOSES ONLY

DO NOT SCALE FROM DRAWING

ISSUED: 04/21/1980 **35 REMINGTON [35 REM]** REVISED: 07/28/2022

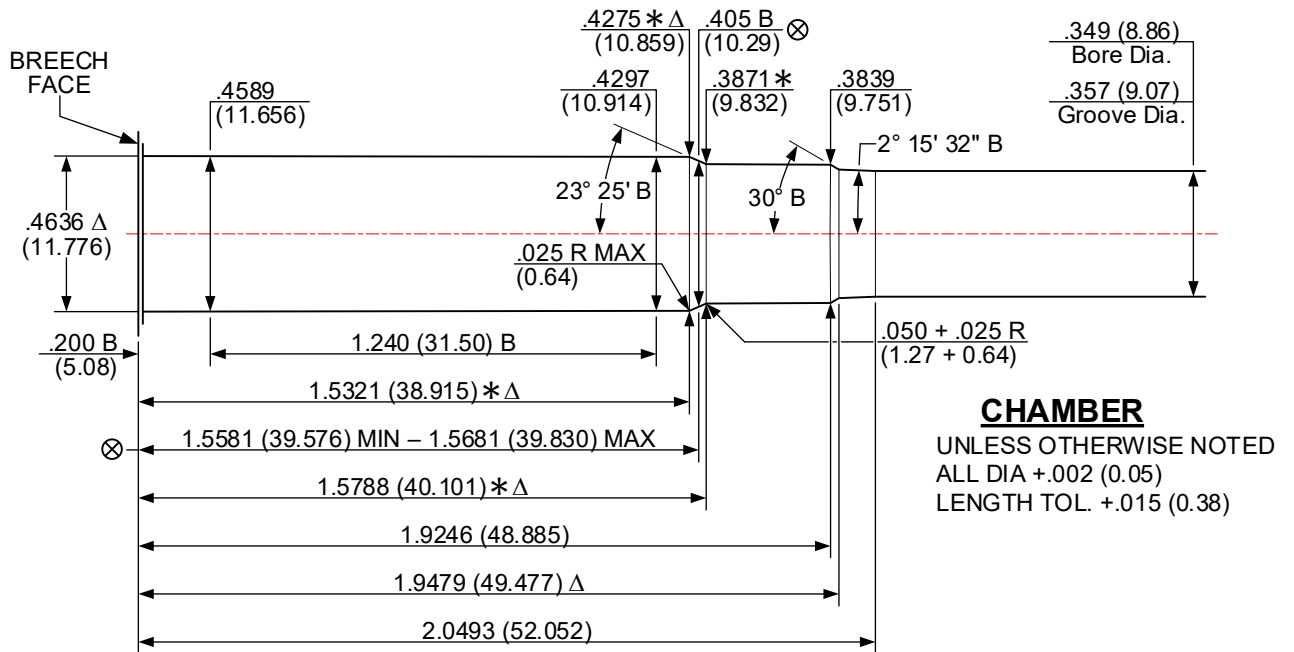
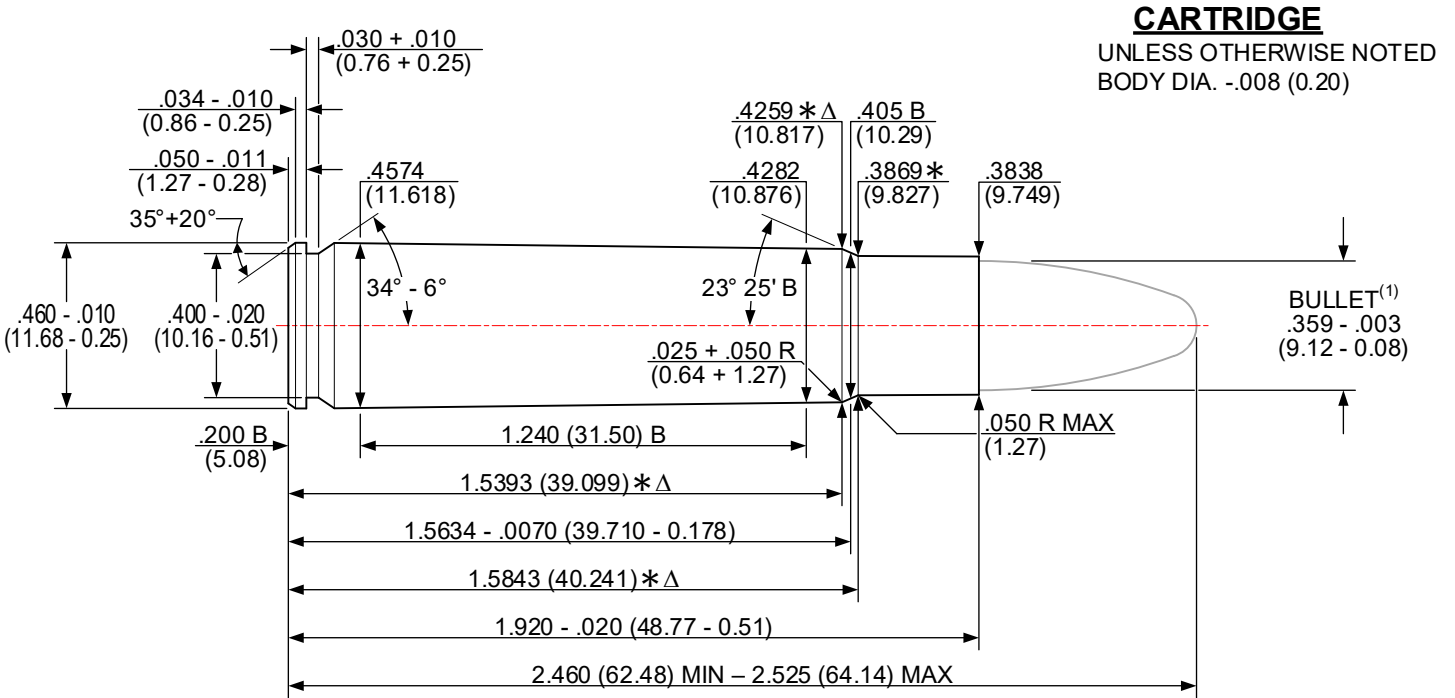

Δ 7 GROOVES TWIST: 16.00 (406.4) R.H. OPTIONAL
 Δ .115+.002 (2.92+0.05) WIDE MINIMUM BORE & GROOVE AREA: .0989 in² (63.806 mm²)

NOTES:
 B = BASIC (XX.XX) = MILLIMETERS ⊗ = HEADSPACE DIMENSION
 Δ = REFERENCE DIMENSION * = DIMENSIONS ARE TO INTERSECTION OF LINES
 ALL CALCULATIONS APPLY AT MAXIMUM MATERIAL CONDITION (MMC)
 (1) – BULLET PROFILE IS SHOWN FOR ILLUSTRATIVE PURPOSES ONLY

DO NOT SCALE FROM DRAWING

ISSUED: 01/08/1988 **35 WHELEN [35 WHELEN]** REVISED: 07/28/2022

CARTRIDGE
 UNLESS OTHERWISE NOTED
 BODY DIA. -.008 (0.20)

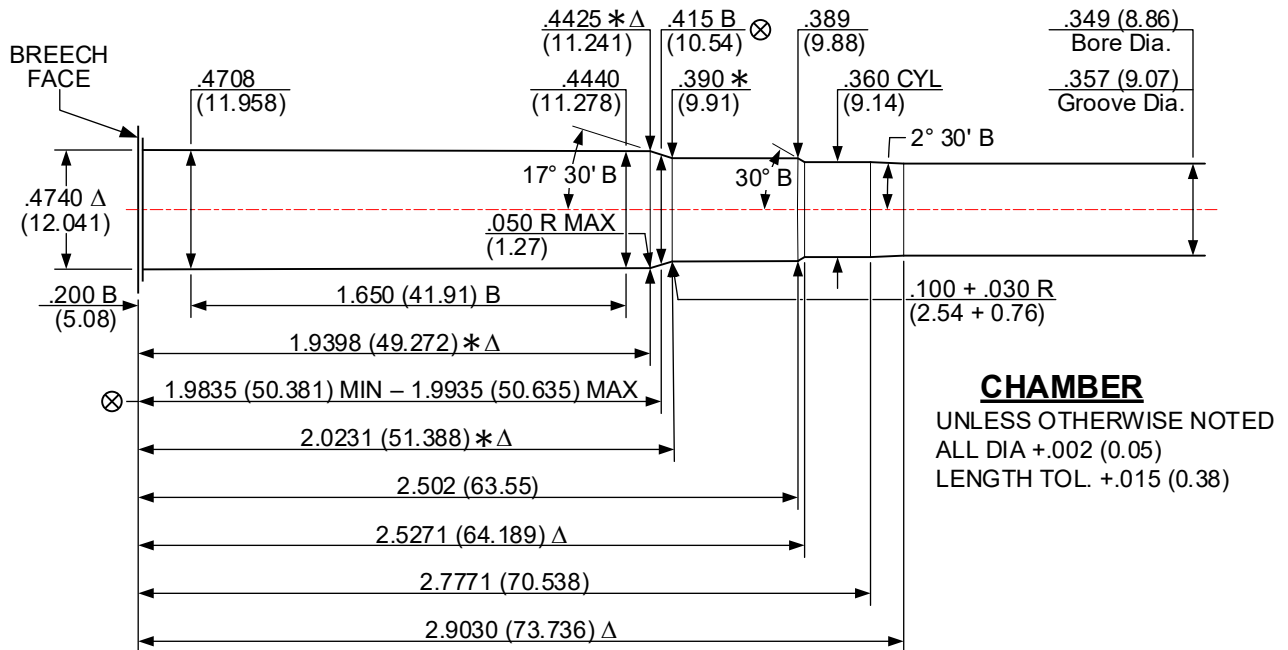
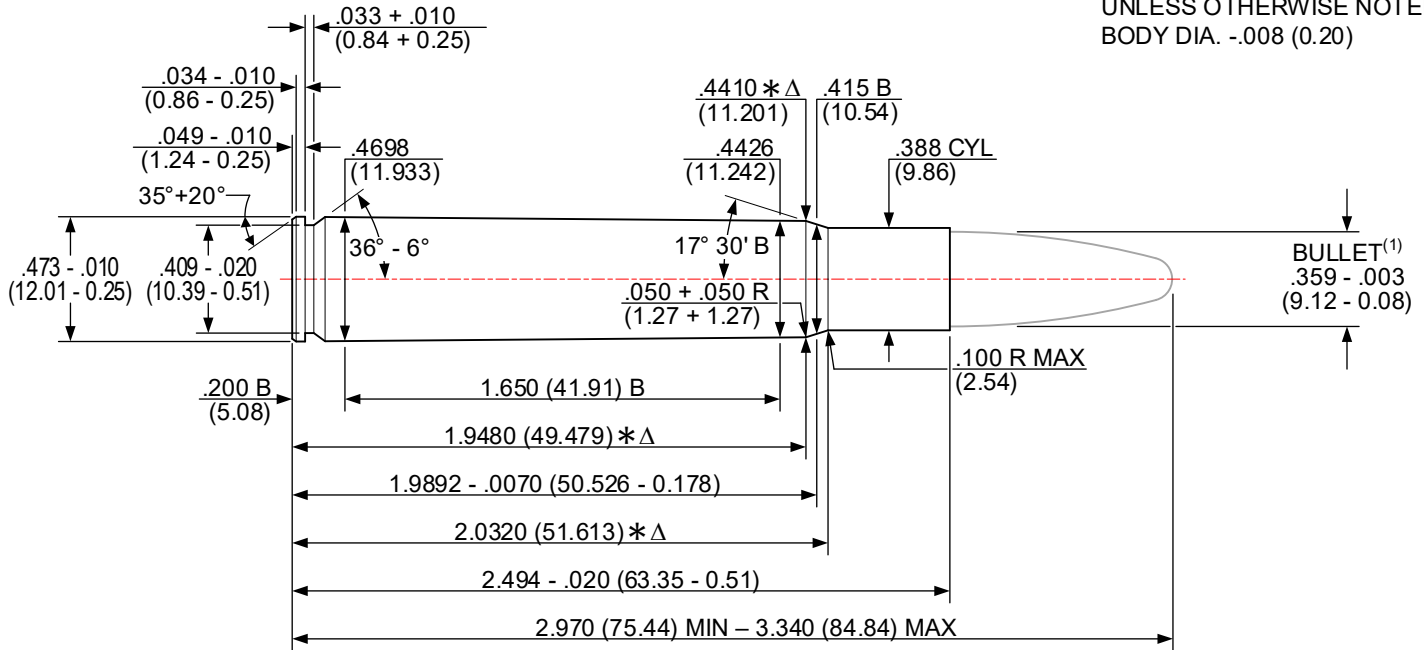

△ 6 GROOVES TWIST: 16.00 (406.4) R.H. OPTIONAL
 △ .130+.002 (3.30+0.05) WIDE MINIMUM BORE & GROOVE AREA: .0988 in² (63.741 mm²)

NOTES:

- B = BASIC (XX.XX) = MILLIMETERS ⊗ = HEADSPACE DIMENSION
- △ = REFERENCE DIMENSION * = DIMENSIONS ARE TO INTERSECTION OF LINES
- ALL CALCULATIONS APPLY AT MAXIMUM MATERIAL CONDITION (MMC)
- (1) – BULLET PROFILE IS SHOWN FOR ILLUSTRATIVE PURPOSES ONLY

DO NOT SCALE FROM DRAWING

NOTICE: This drawing is subject to change.
 Revisions, if applicable, are available at www.saami.org.

ISSUED: 01/21/2019

350 LEGEND [350 LGND]

REVISED: 08/01/2022

CARTRIDGE

UNLESS OTHERWISE NOTED
 BODY DIA. -.008 (0.20)

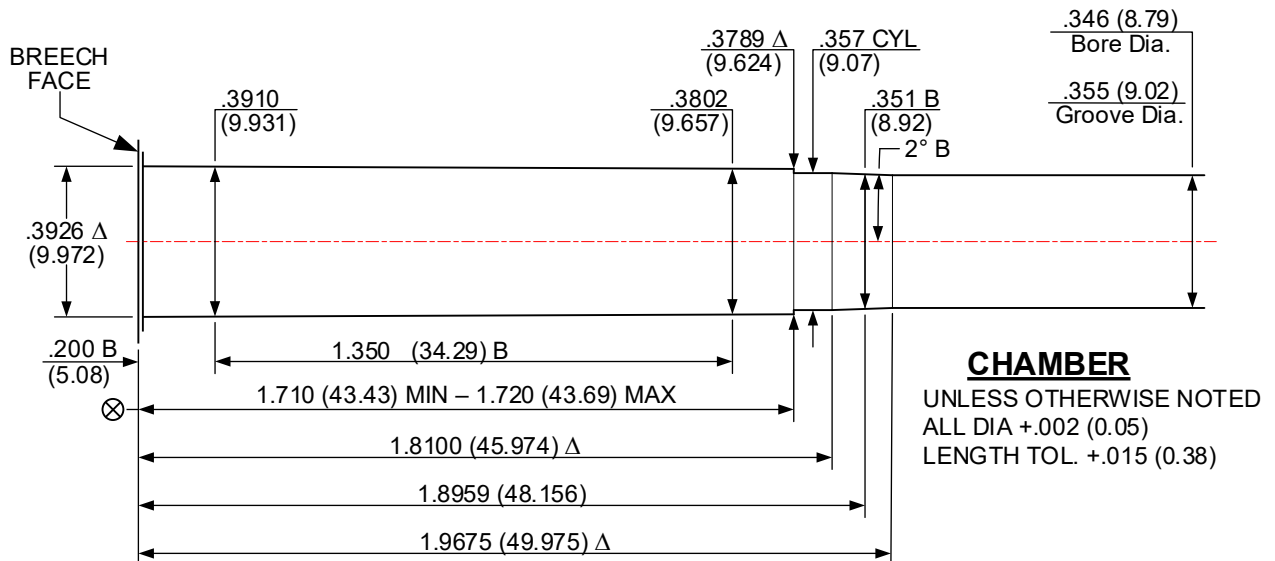
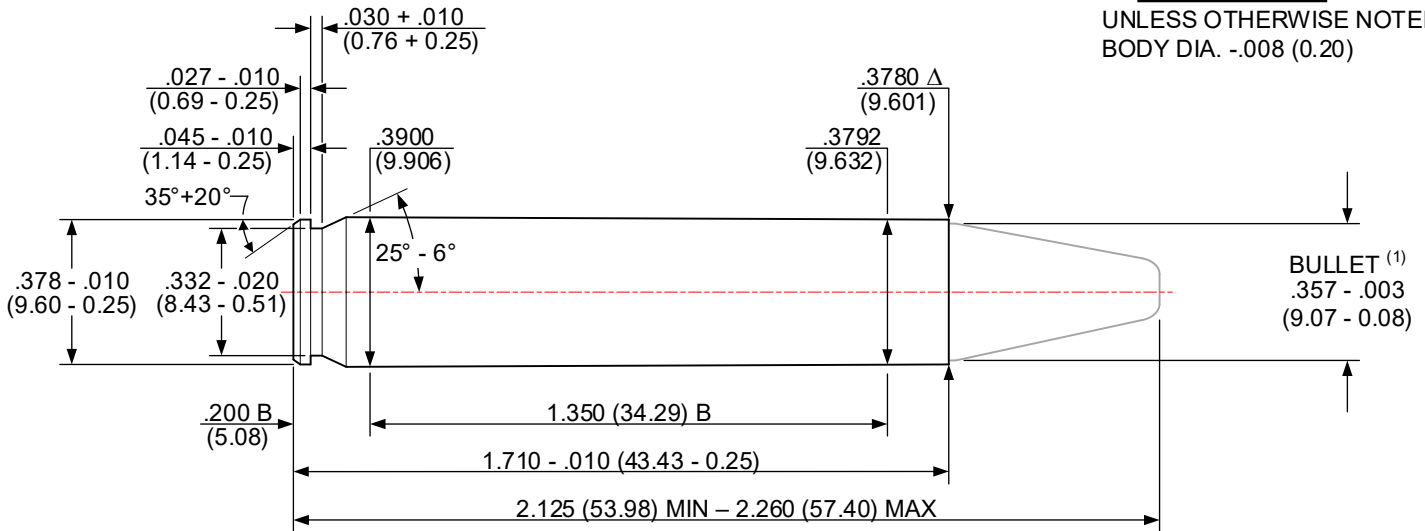

Δ 6 GROOVES TWIST: 16.00 (406.4) R.H. OPTIONAL
 Δ .100+.002 (2.54+0.05) WIDE MIN. BORE & GROOVE AREA: .0967 in² (62.386 mm²)

NOTES:

- B = BASIC (XX.XX) = MILLIMETERS ⊗ = HEADSPACE DIMENSION
- Δ = REFERENCE DIMENSION * = DIMENSIONS ARE TO INTERSECTION OF LINES
- ALL CALCULATIONS APPLY AT MAXIMUM MATERIAL CONDITION (MMC)
- (1) – BULLET PROFILE IS SHOWN FOR ILLUSTRATIVE PURPOSES ONLY

DO NOT SCALE FROM DRAWING

ISSUED: 11/08/1983

356 WINCHESTER [356 WIN]

REVISED: 07/25/2023

CARTRIDGE

UNLESS OTHERWISE NOTED
 BODY DIA. -.008 (0.20)

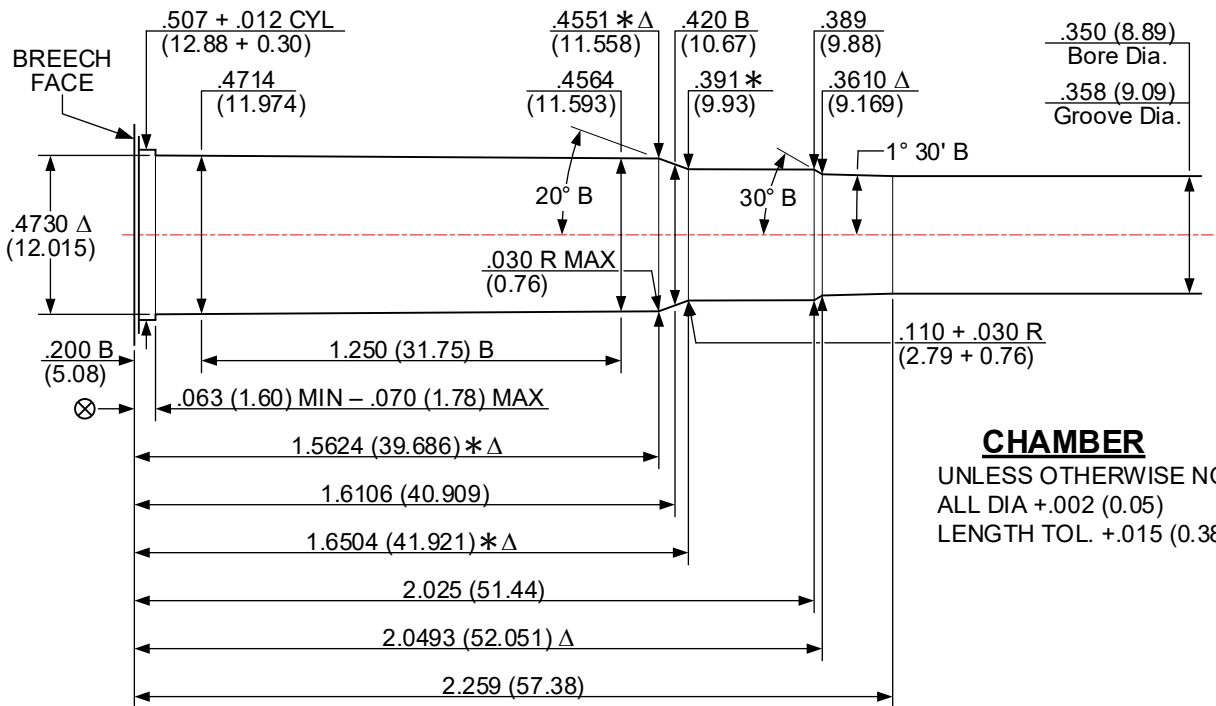
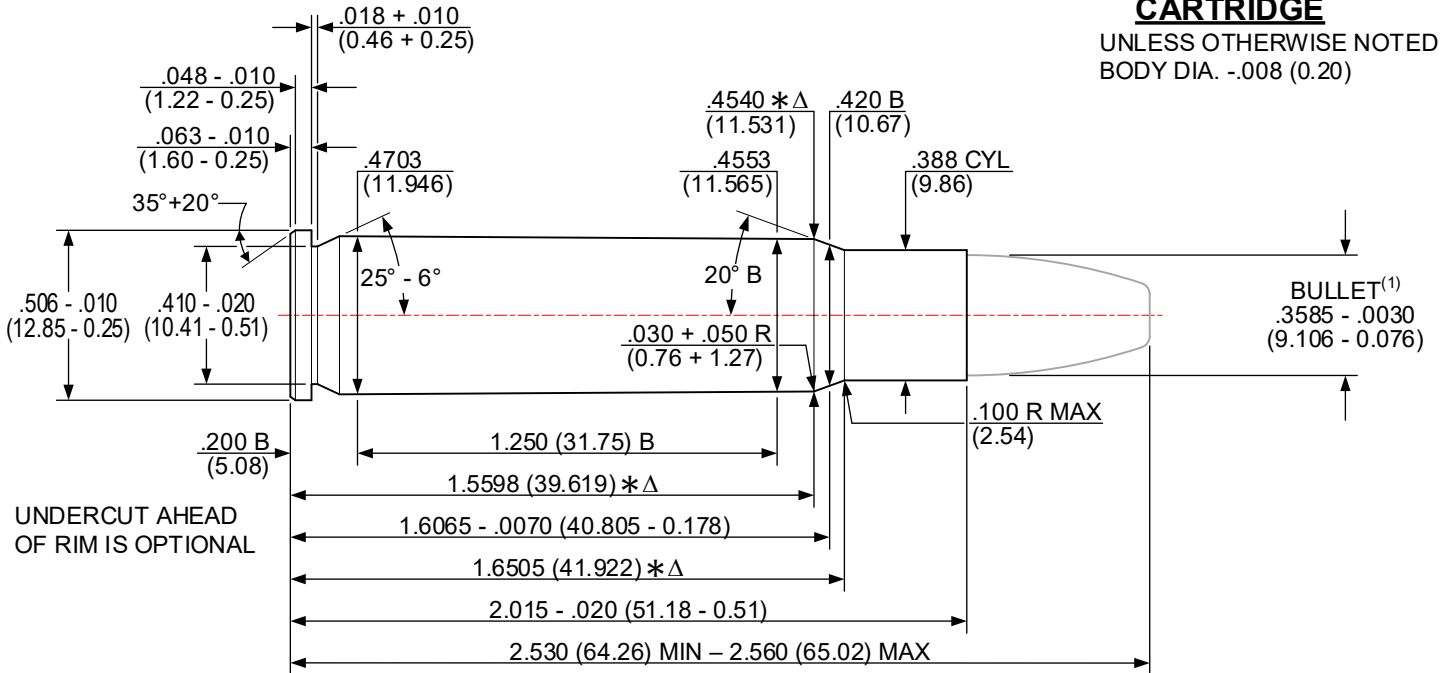

CHAMBER

UNLESS OTHERWISE NOTED
 ALL DIA +.002 (0.05)
 LENGTH TOL. +.015 (0.38)

Δ 6 GROOVES
 Δ .1099 +.0020 (2.791+0.051) WIDE

TWIST: 12.00 (304.8) R.H. OPTIONAL
 MINIMUM BORE & GROOVE AREA: .0988 in² (63.741 mm²)

NOTES:

- B = BASIC
- Δ = REFERENCE DIMENSION
- ALL CALCULATIONS APPLY AT MAXIMUM MATERIAL CONDITION (MMC)
- (1) – BULLET PROFILE IS SHOWN FOR ILLUSTRATIVE PURPOSES ONLY
- (XX.XX) = MILLIMETERS
- * = DIMENSIONS ARE TO INTERSECTION OF LINES
- ⊗ = HEAD SPACE DIMENSION

DO NOT SCALE FROM DRAWING

NOTICE: This drawing is subject to change.
 Revisions, if applicable, are available at www.saami.org.

ISSUED: 05/29/1979 **358 WINCHESTER [358 WIN]** REVISED: 08/03/2022

CARTRIDGE

UNLESS OTHERWISE NOTED
 BODY DIA. -.008 (0.20)

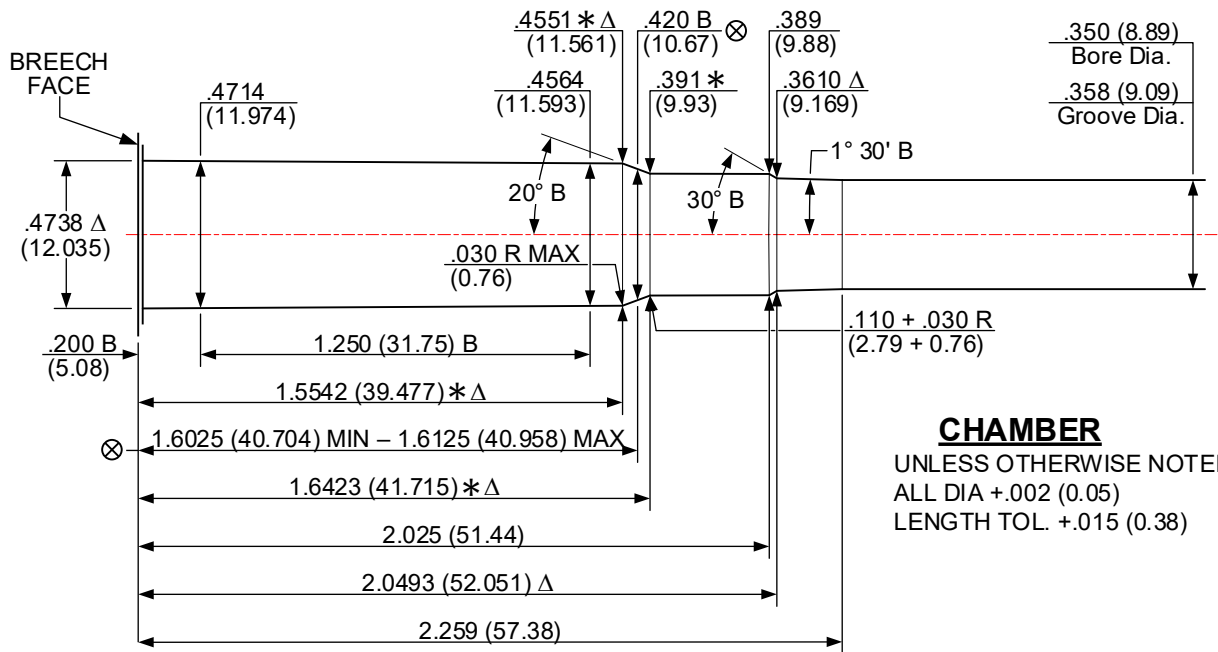
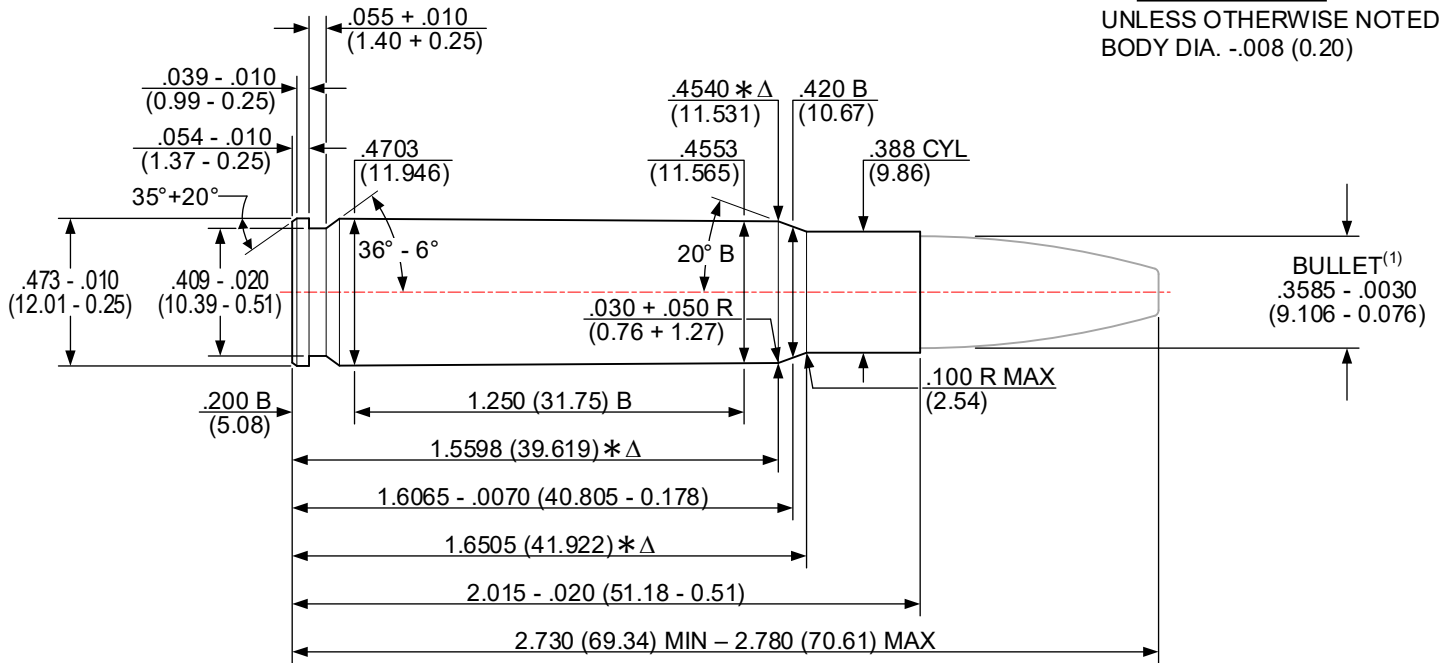

CHAMBER

UNLESS OTHERWISE NOTED
 ALL DIA +.002 (0.05)
 LENGTH TOL. +.015 (0.38)

Δ 6 GROOVES
 Δ .1099+.0020 (2.791+0.051) WIDE

TWIST: 12.00 (304.8) R.H. OPTIONAL
 MINIMUM BORE & GROOVE AREA: .0988 in² (63.741 mm²)

NOTES:

- B = BASIC
- Δ = REFERENCE DIMENSION
- ALL CALCULATIONS APPLY AT MAXIMUM MATERIAL CONDITION (MMC)
- (1) – BULLET PROFILE IS SHOWN FOR ILLUSTRATIVE PURPOSES ONLY
- (XX.XX) = MILLIMETERS
- * = DIMENSIONS ARE TO INTERSECTION OF LINES
- ⊗ = HEADSPACE DIMENSION

DO NOT SCALE FROM DRAWING

NOTICE: This drawing is subject to change.
 Revisions, if applicable, are available at www.saami.org.

ISSUED: 01/15/2023

360 BUCKHAMMER [360 BHMR]

REVISED: 02/10/2023

CARTRIDGE

UNLESS OTHERWISE NOTED
 BODY DIA. -.008 (0.20)

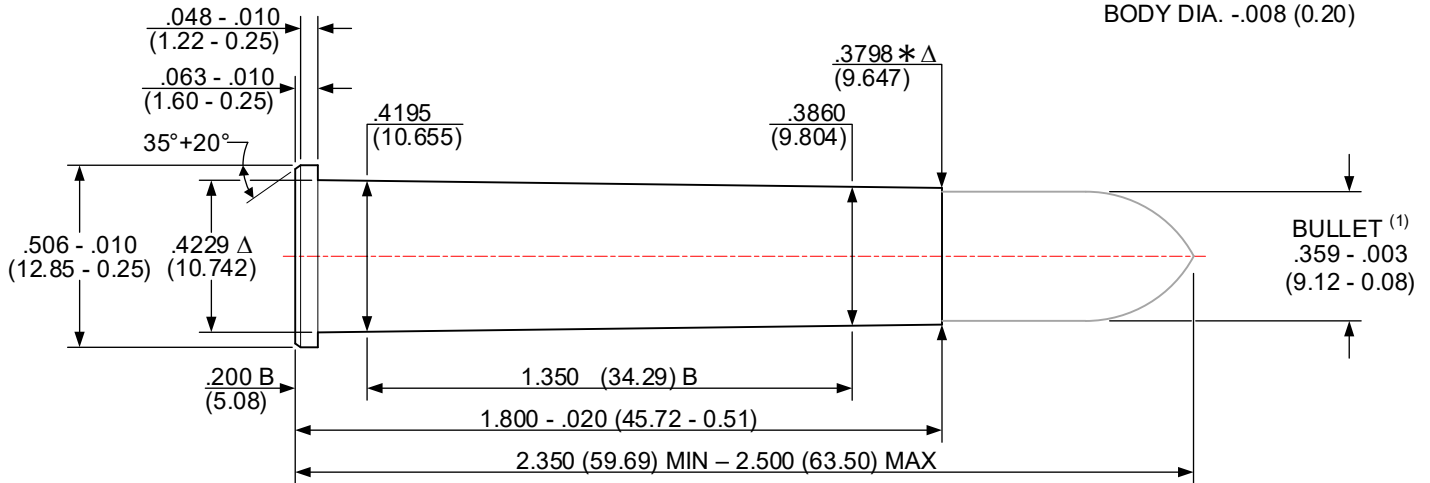

UNDERCUT AHEAD OF
 RIM IS OPTIONAL

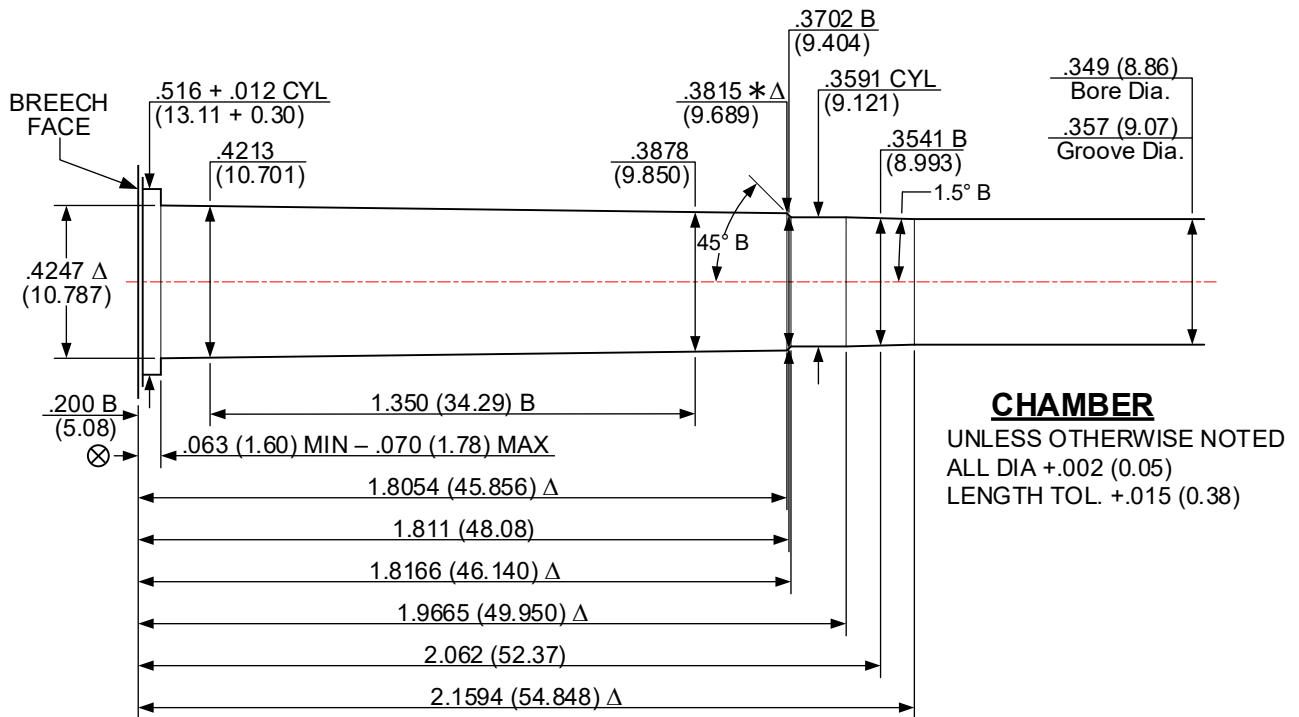

CHAMBER

UNLESS OTHERWISE NOTED
 ALL DIA +.002 (0.05)
 LENGTH TOL. +.015 (0.38)

Δ 7 GROOVES TWIST: 12.00 [304.8] R.H. OPTIONAL
 Δ .115+.002 [2.92+0.05] WIDE MINIMUM BORE & GROOVE AREA: .0989 in² [63.806 mm²]

NOTES:

- B = BASIC (XX.XX) = MILLIMETERS ⊗ = HEADSPACE DIMENSION
- Δ = REFERENCE DIMENSION * = DIMENSIONS ARE TO INTERSECTION OF LINES
- ALL CALCULATIONS APPLY AT MAXIMUM MATERIAL CONDITION (MMC)
- (1) – BULLET PROFILE IS SHOWN FOR ILLUSTRATIVE PURPOSES ONLY

DO NOT SCALE FROM DRAWING

NOTICE: This drawing is subject to change.
 Revisions, if applicable, are available at www.saami.org.

ISSUED: 01/14/2010

370 SAKO MAGNUM [370 SAKO MAG]

REVISED: 10/11/2024

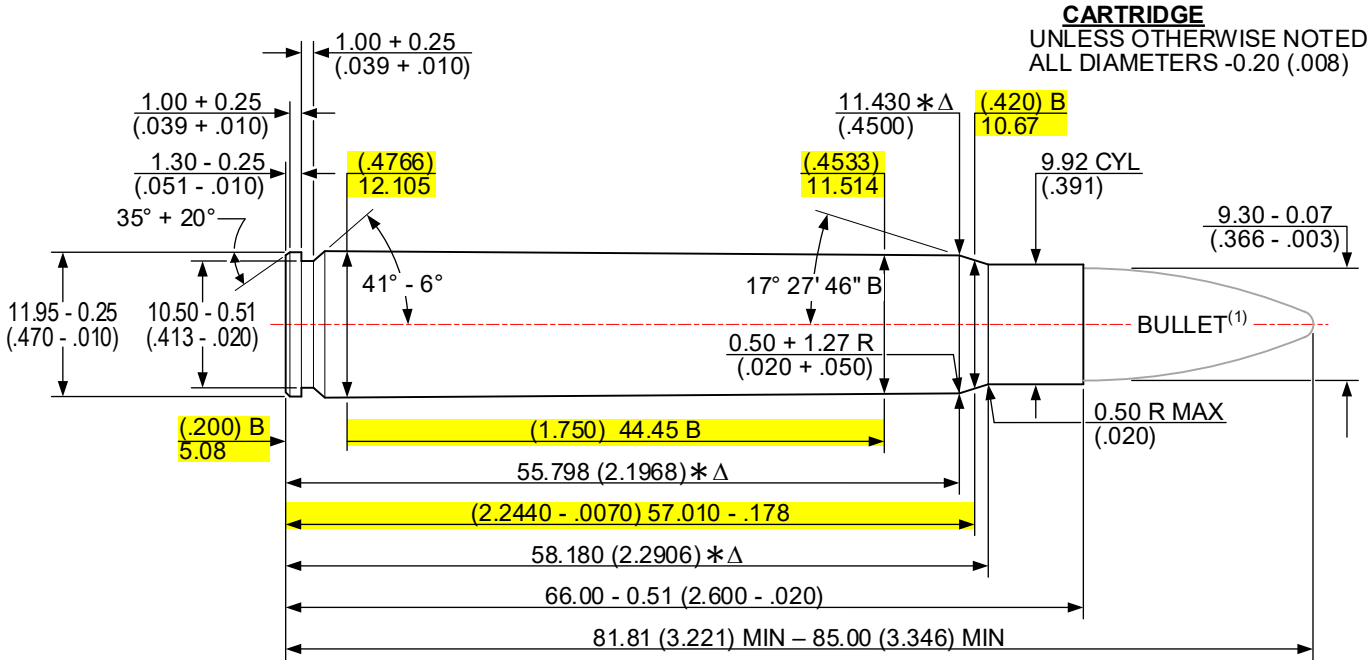

HIGHLIGHTED DIMENSIONS HAVE NO CORRESPONDING C.I.P. ANALOG. THE ENGLISH UNITS FOR THESE ARE THE ORIGINAL VALUES; METRIC VALUES ARE CALCULATED AND ROUNDED.

CHAMBER

UNLESS OTHERWISE NOTED
 ALL DIA. +0.05 (.002)
 LENGTH TOL +0.38 (.015)

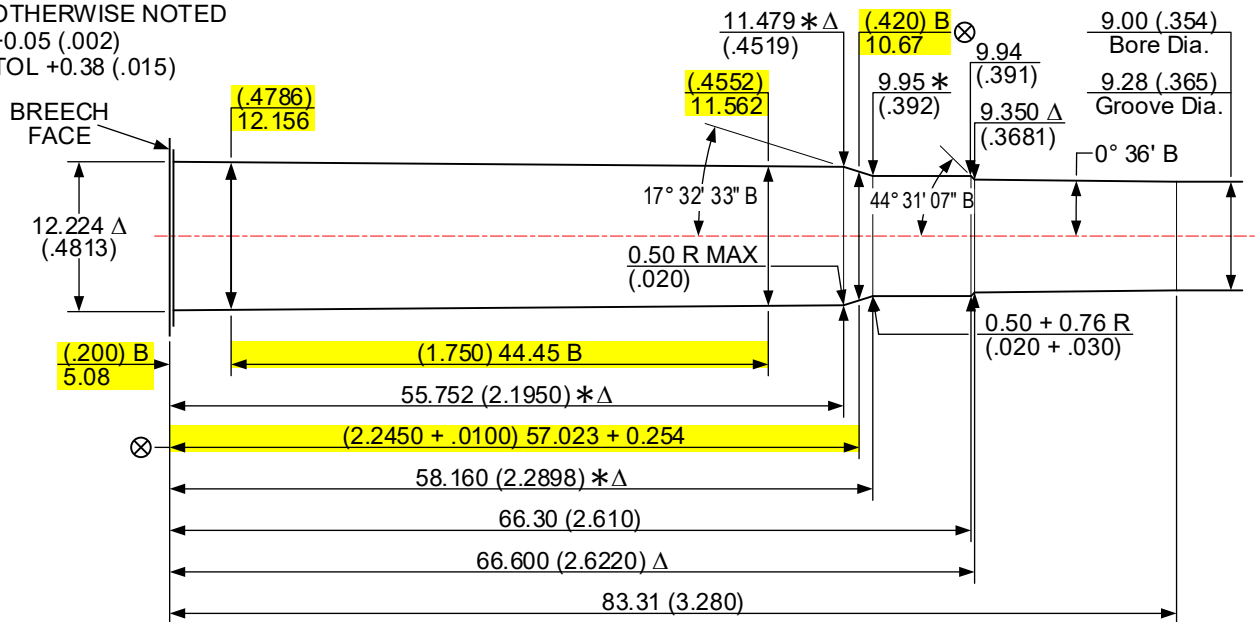

Δ 6 GROOVES TWIST: 360.0 (14.17) RH OPTIONAL
 Δ 3.14 + 0.05 (.124 + .002) WIDE MINIMUM BORE & GROOVE AREA: 66.310 mm² (.1028 in²)

NOTES:

- B = BASIC
- Δ = REFERENCE DIMENSION
- ALL CALCULATIONS APPLY AT MAXIMUM MATERIAL CONDITION (MMC)
- (1) – BULLET PROFILE IS SHOWN FOR ILLUSTRATIVE PURPOSES ONLY
- (XX.XX) = INCHES
- * = DIMENSIONS ARE TO INTERSECTION OF LINES
- ⊗ = HEADSPACE DIMENSION

DO NOT SCALE FROM DRAWING

METRIC ORIGIN (9.3 x 66 SAKO)

NOTICE: This drawing is subject to change. Revisions, if applicable, are available at www.saami.org.

ISSUED: 04/21/1980 **375 HOLLAND & HOLLAND MAGNUM [375 H&H MAG]** REVISED: 08/03/2022

CARTRIDGE

UNLESS OTHERWISE NOTED
 BODY DIA. -.008 (0.20)

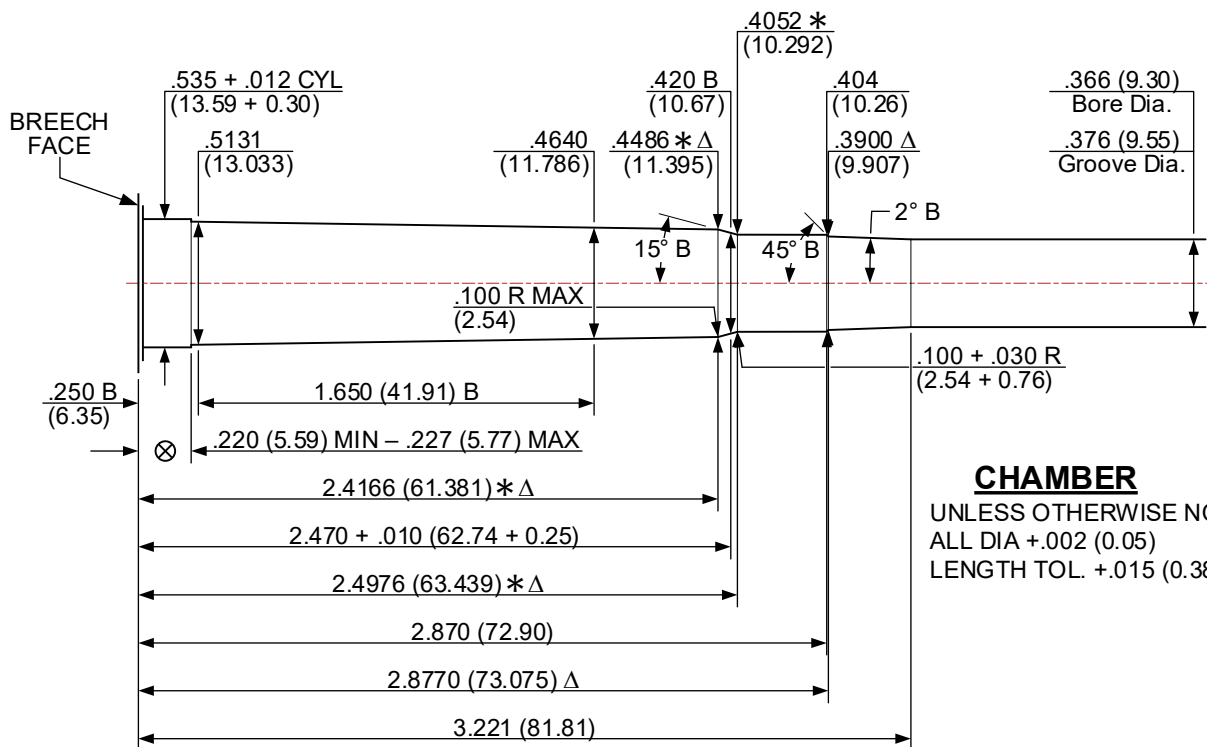
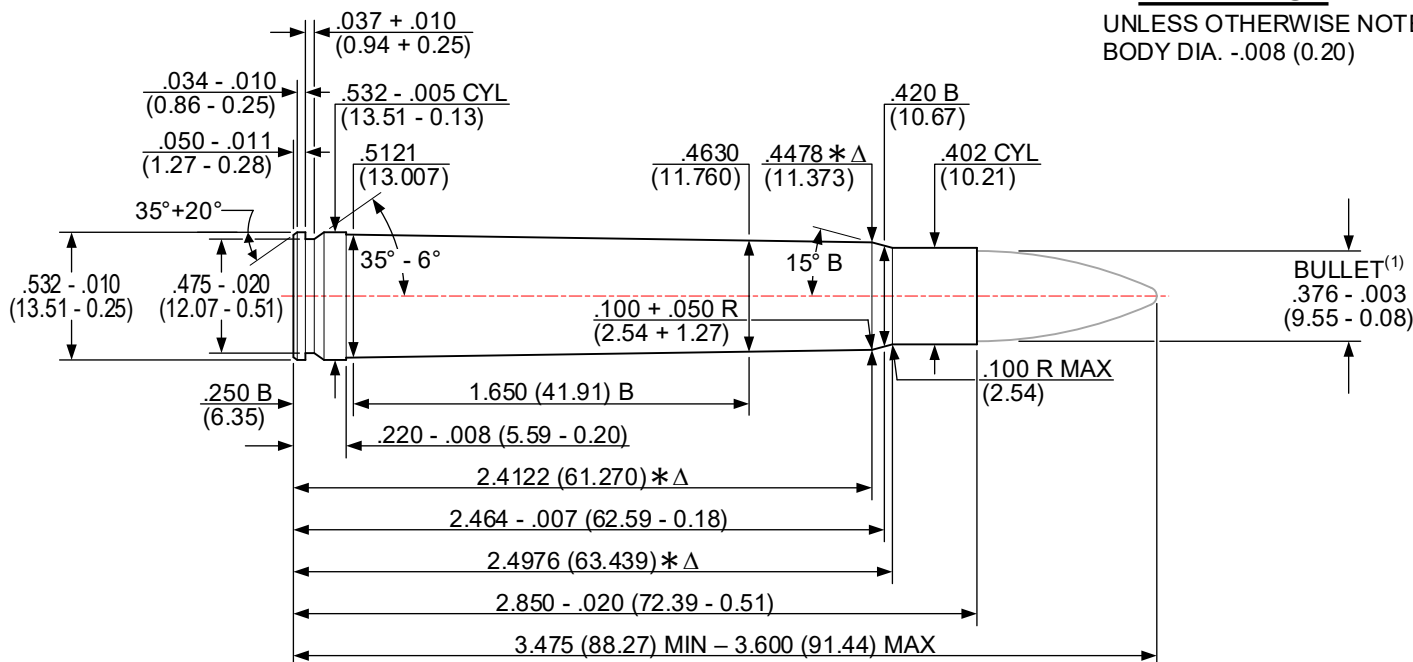

CHAMBER

UNLESS OTHERWISE NOTED
 ALL DIA +.002 (0.05)
 LENGTH TOL. +.015 (0.38)

△ 6 GROOVES TWIST: 12.00 (304.8) R.H. OPTIONAL
 △ .115+.002 (2.92+0.05) WIDE MINIMUM BORE & GROOVE AREA: .1087 in² (70.128 mm²)

NOTES:

- B = BASIC (XX.XX) = MILLIMETERS ⊗ = HEADSPACE DIMENSION
- △ = REFERENCE DIMENSION * = DIMENSIONS ARE TO INTERSECTION OF LINES
- ALL CALCULATIONS APPLY AT MAXIMUM MATERIAL CONDITION (MMC)
- (1) – BULLET PROFILE IS SHOWN FOR ILLUSTRATIVE PURPOSES ONLY

DO NOT SCALE FROM DRAWING

NOTICE: This drawing is subject to change.
 Revisions, if applicable, are available at www.saami.org.

ISSUED: 01/10/2001 **375 REMINGTON ULTRA MAGNUM [375 REM ULTRA MAG]** REVISED: 08/05/2022

CARTRIDGE

UNLESS OTHERWISE NOTED
 BODY DIA. -.008 (0.20)

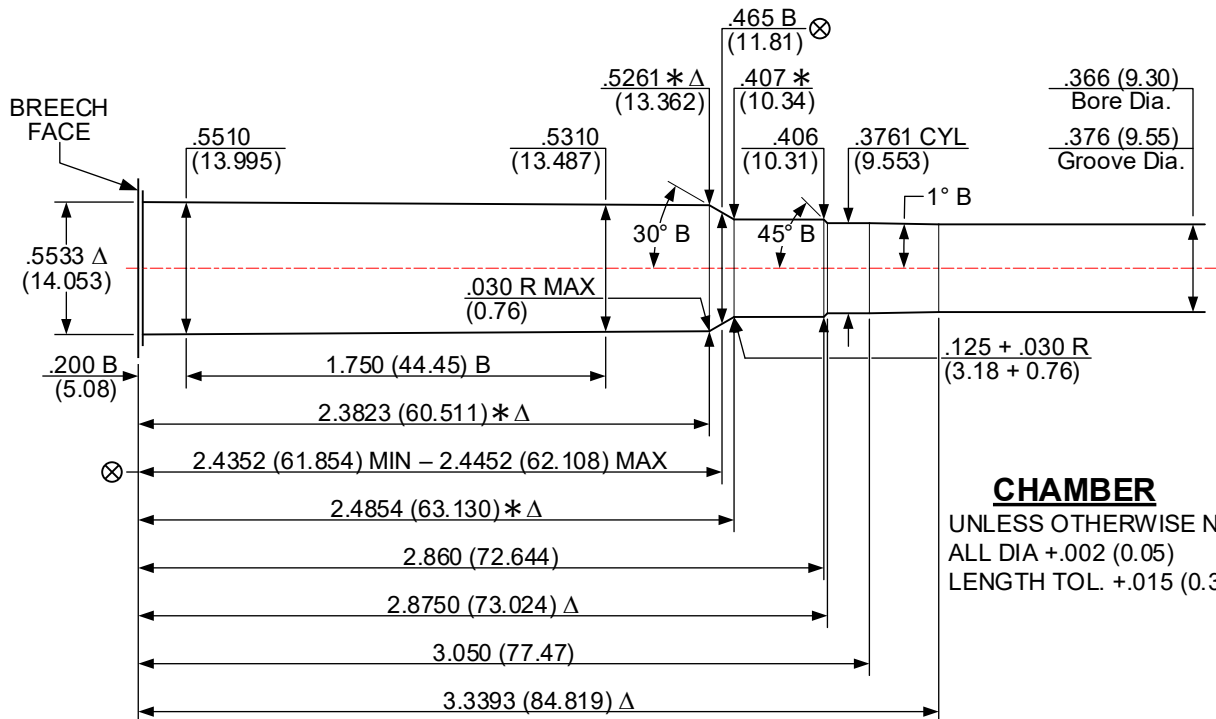
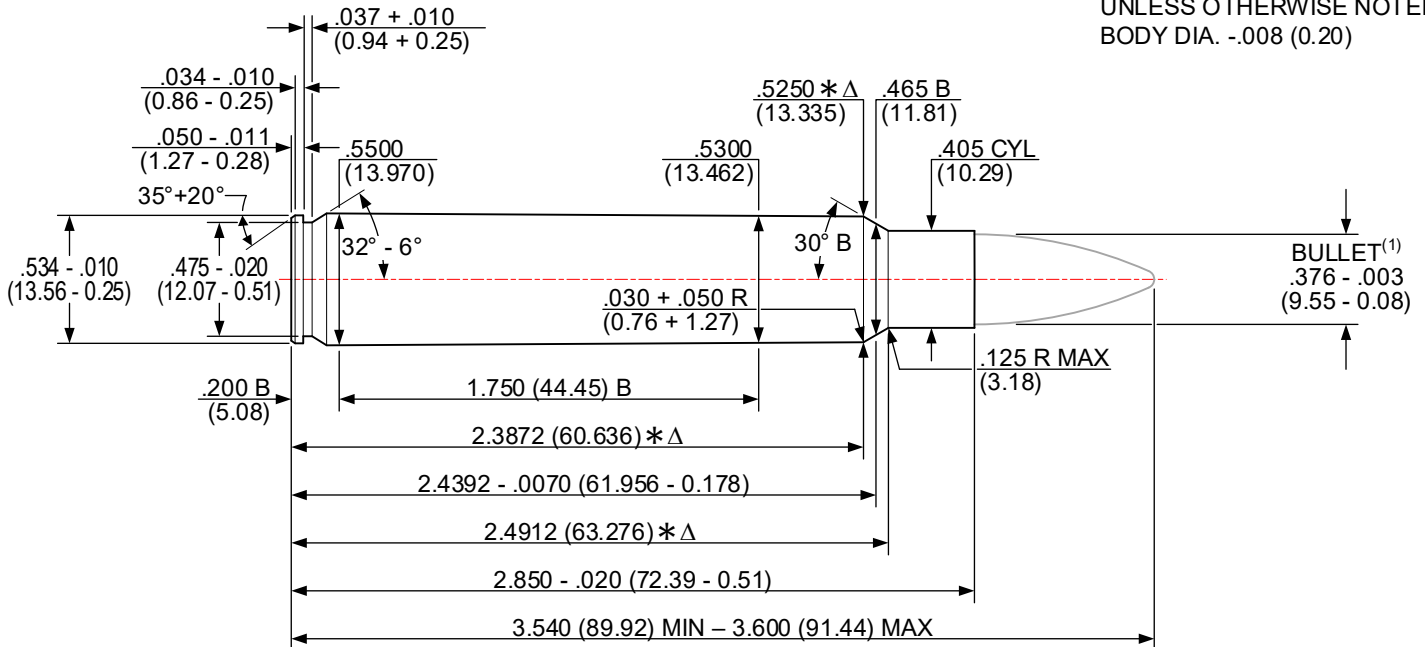

CHAMBER

UNLESS OTHERWISE NOTED
 ALL DIA +.002 (0.05)
 LENGTH TOL. +.015 (0.38)

Δ 6 GROOVES TWIST: 12.00 (304.8) R.H. OPTIONAL
 Δ .115+.002 (2.92+0.05) WIDE MINIMUM BORE & GROOVE AREA: .1087 in² (70.128 mm²)

NOTES:

- B = BASIC
- Δ = REFERENCE DIMENSION
- ALL CALCULATIONS APPLY AT MAXIMUM MATERIAL CONDITION (MMC)
- (1) – BULLET PROFILE IS SHOWN FOR ILLUSTRATIVE PURPOSES ONLY
- (XX.XX) = MILLIMETERS
- * = DIMENSIONS ARE TO INTERSECTION OF LINES
- ⊗ = HEADSPACE DIMENSION

DO NOT SCALE FROM DRAWING

NOTICE: This drawing is subject to change.
 Revisions, if applicable, are available at www.saami.org.

ISSUED: 06/13/2007

375 RUGER [375 RUGER]

REVISED: 08/05/2022

CARTRIDGE

UNLESS OTHERWISE NOTED
 BODY DIA. -.008 (0.20)

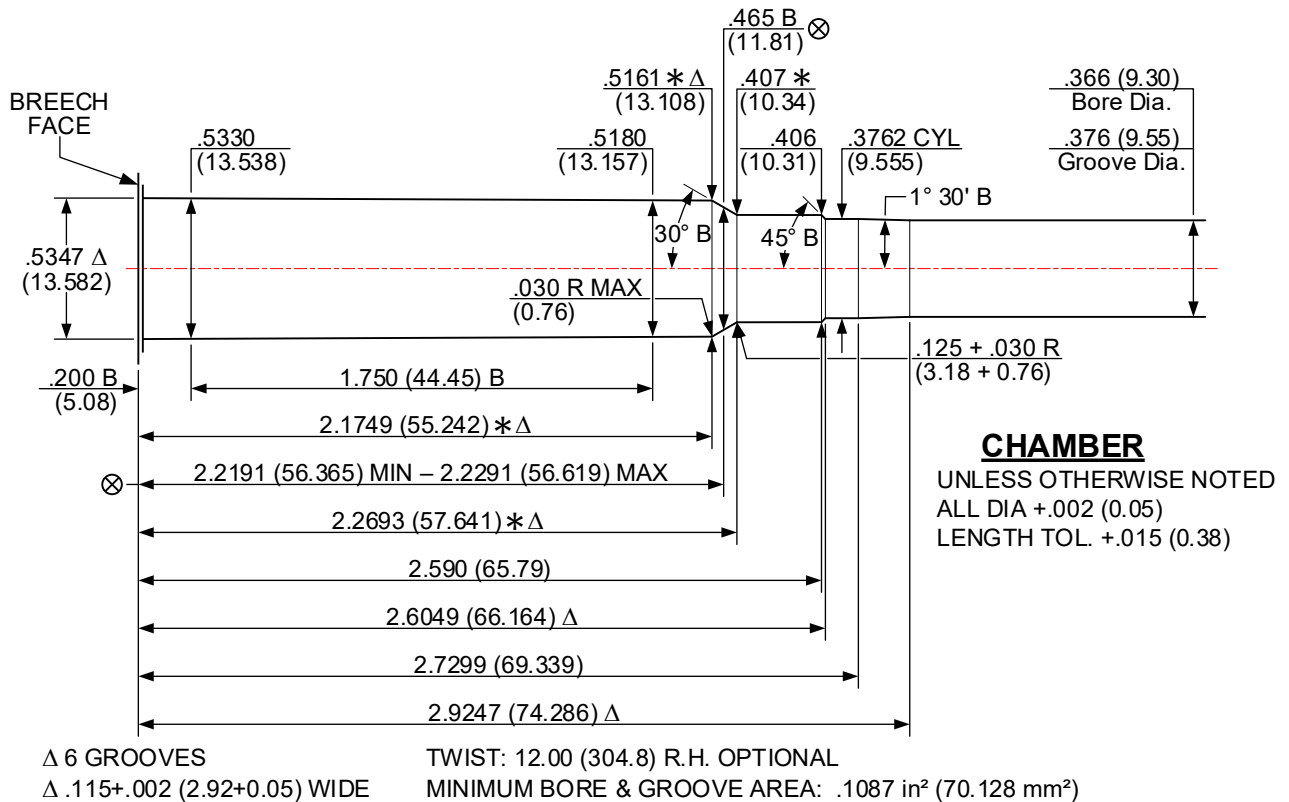
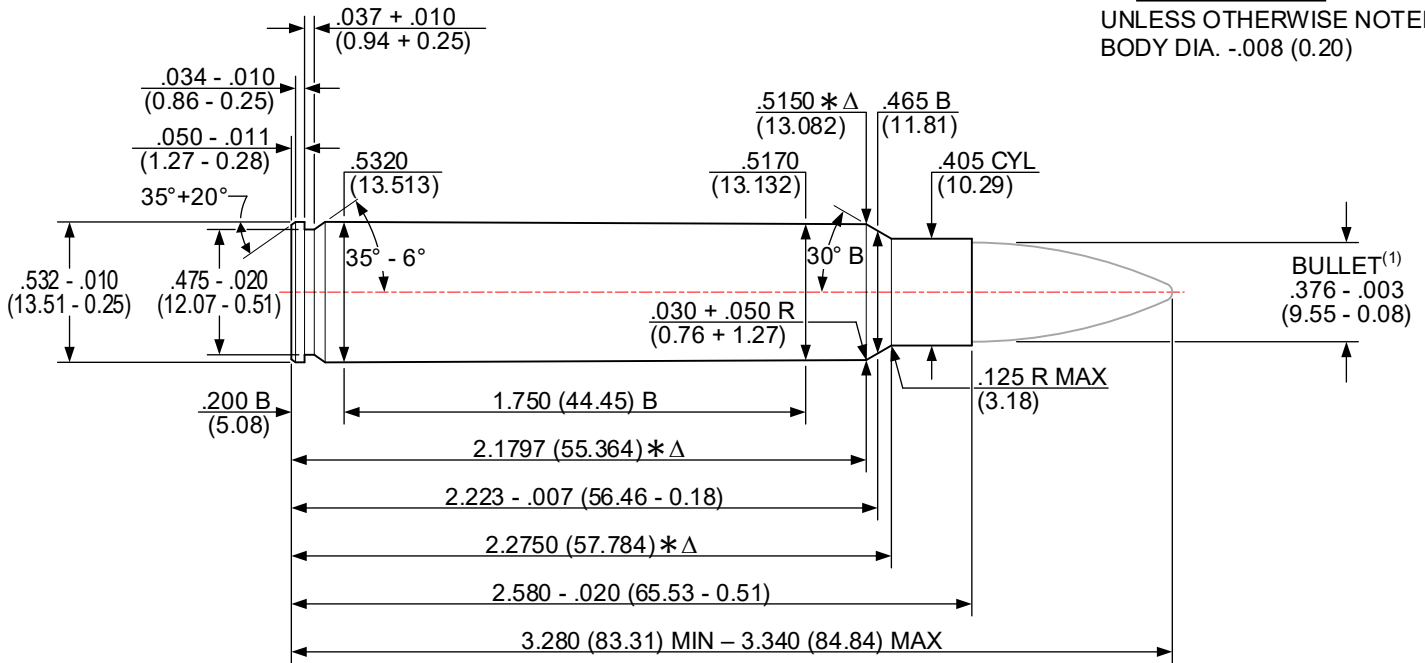

NOTES:

- B = BASIC
- Δ = REFERENCE DIMENSION
- ALL CALCULATIONS APPLY AT MAXIMUM MATERIAL CONDITION (MMC)
- (1) – BULLET PROFILE IS SHOWN FOR ILLUSTRATIVE PURPOSES ONLY
- (XX.XX) = MILLIMETERS
- * = DIMENSIONS ARE TO INTERSECTION OF LINES
- ⊗ = HEADSPACE DIMENSION

DO NOT SCALE FROM DRAWING

NOTICE: This drawing is subject to change.
 Revisions, if applicable, are available at www.saami.org.

ISSUED: 05/29/1979 **375 WINCHESTER [375 WIN]** REVISED: 02/10/2023

CARTRIDGE

UNLESS OTHERWISE NOTED
 BODY DIA. -.008 (0.20)

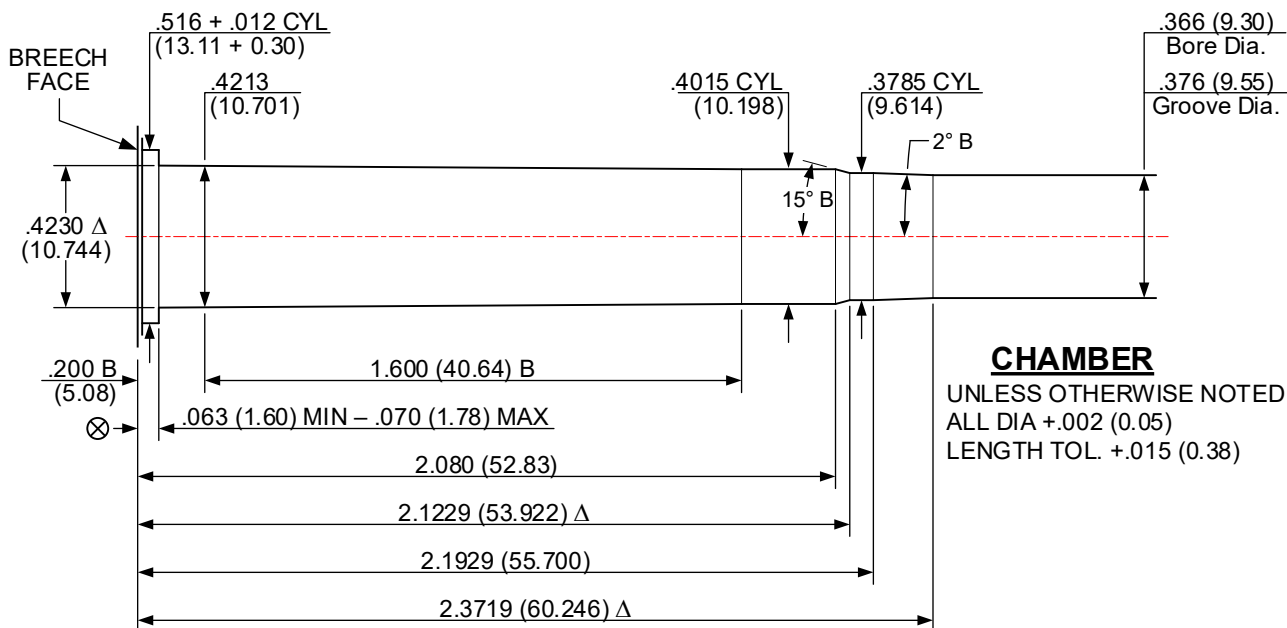
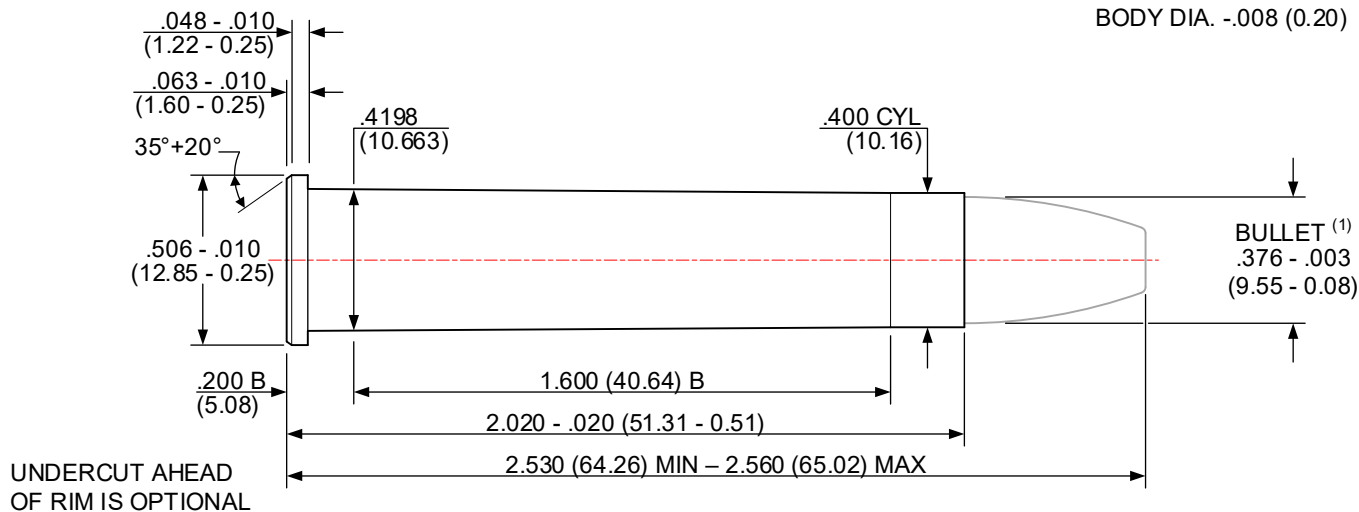

Δ 7 GROOVES TWIST: 12.00 (304.8) R.H. OPTIONAL
 Δ .115+.002 (2.92+0.05) WIDE MINIMUM BORE & GROOVE AREA: .1087 in² (70.128 mm²)

NOTES:

- B = BASIC (XX.XX) = MILLIMETERS ⊗ = HEADSPACE DIMENSION
- Δ = REFERENCE DIMENSION * = DIMENSIONS ARE TO INTERSECTION OF LINES
- ALL CALCULATIONS APPLY AT MAXIMUM MATERIAL CONDITION (MMC)
- (1) – BULLET PROFILE IS SHOWN FOR ILLUSTRATIVE PURPOSES ONLY

DO NOT SCALE FROM DRAWING

NOTICE: This drawing is subject to change.
 Revisions, if applicable, are available at www.saami.org.

ISSUED: 02/24/2016

376 STEYR [376 STEYR]

REVISED: 10/11/2024

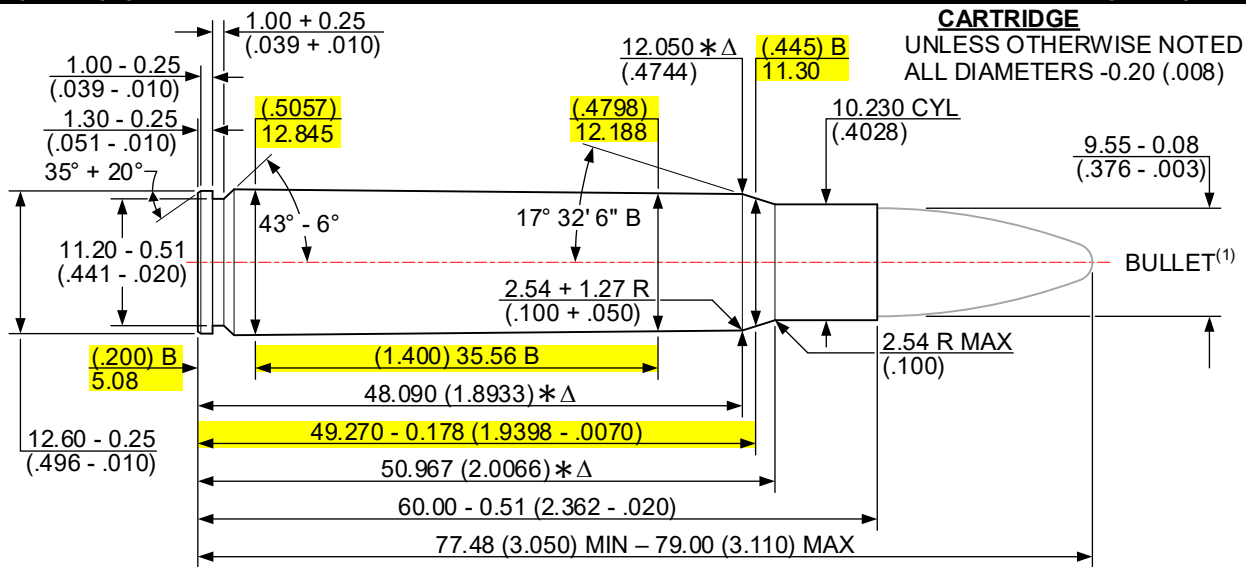

CARTRIDGE
 UNLESS OTHERWISE NOTED
 ALL DIAMETERS -0.20 (.008)

HIGHLIGHTED DIMENSIONS HAVE NO CORRESPONDING C.I.P. ANALOG. THE ENGLISH UNITS FOR THESE ARE THE ORIGINAL VALUES; METRIC VALUES ARE CALCULATED AND ROUNDED.

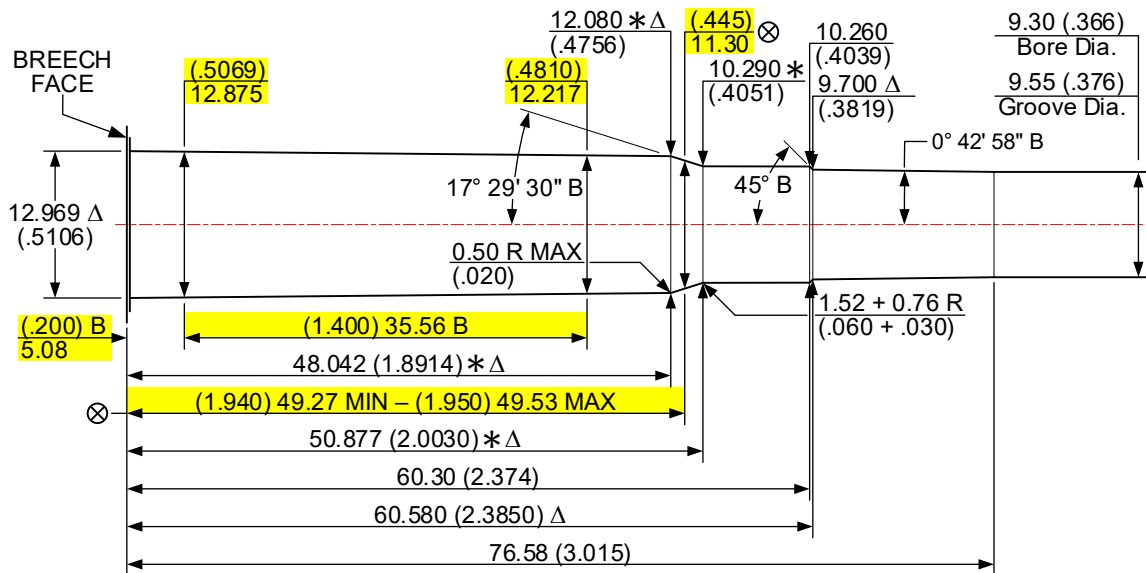

CHAMBER
 UNLESS OTHERWISE NOTED
 ALL DIA. +0.05 (.002)
 LENGTH TOL +0.38 (.015)

Δ 6 GROOVES TWIST: 304.8 (12.00) RH OPTIONAL
 Δ 2.92 + 0.05 (.115 + .002) WIDE MINIMUM BORE & GROOVE AREA: 70.128 mm² (.1087 in²)

NOTES:

- B = BASIC Δ = REFERENCE DIMENSION ⊗ = HEADSPACE DIMENSION
- * DIMENSIONS ARE TO INTERSECTIONS OF LINES (XX.XXX) = INCHES
- ALL CALCULATIONS APPLY AT MAXIMUM MATERIAL CONDITION (MMC)
- (1) – BULLET PROFILE IS SHOWN FOR ILLUSTRATIVE PURPOSES ONLY

DO NOT SCALE FROM DRAWING

METRIC ORIGIN

NOTICE: This drawing is subject to change.
 Revisions, if applicable, are available at www.saami.org.

ISSUED: 05/29/1979 **38-40 WINCHESTER [38-40 WIN]** REVISED: 02/10/2023

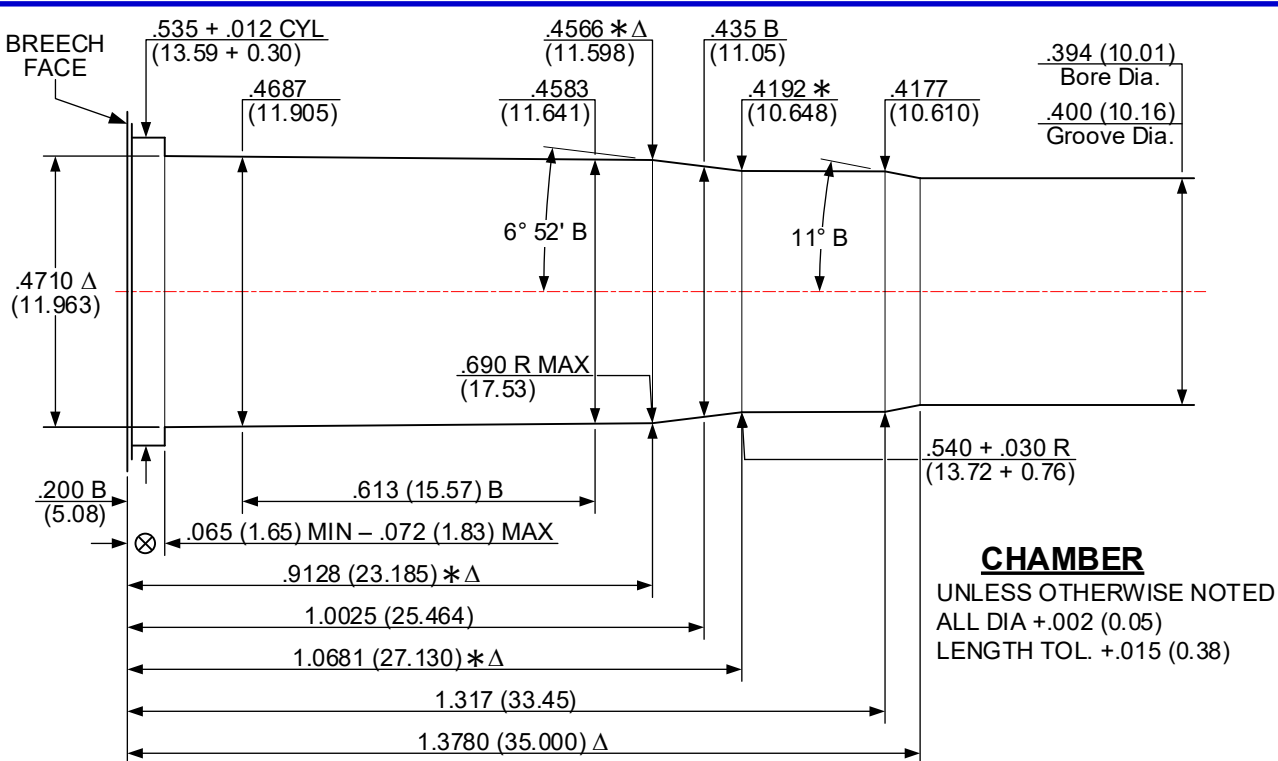
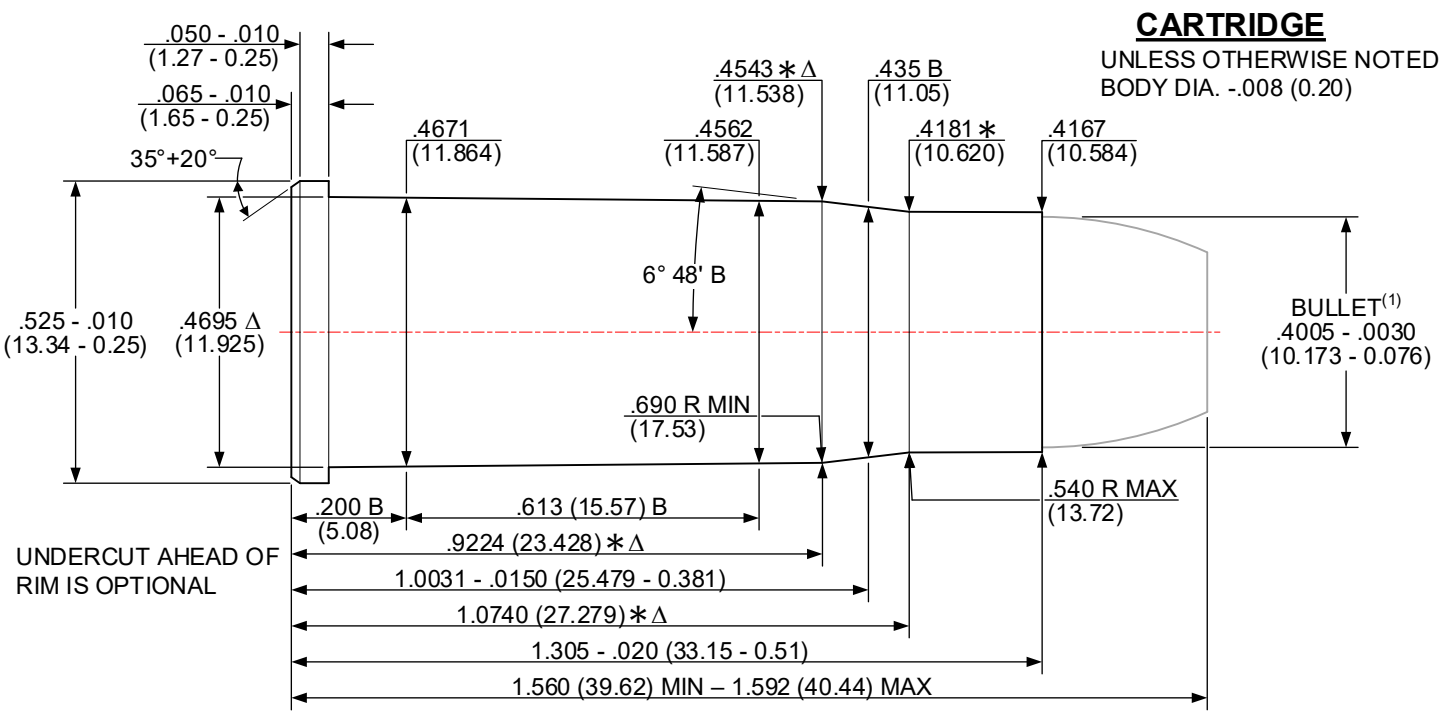

△ 6 GROOVES TWIST: 36.00 (914.4) R.H. OPTIONAL
 △ .1237+.0020 (3.142+0.051) WIDE MINIMUM BORE & GROOVE AREA: .1241 in² (80.064 mm²)

NOTES:
 B = BASIC (XX.XX) = MILLIMETERS ⊗ = HEAD SPACE DIMENSION
 △ = REFERENCE DIMENSION * = DIMENSIONS ARE TO INTERSECTION OF LINES
 ALL CALCULATIONS APPLY AT MAXIMUM MATERIAL CONDITION (MMC)
 (1) – BULLET PROFILE IS SHOWN FOR ILLUSTRATIVE PURPOSES ONLY

DO NOT SCALE FROM DRAWING

NOTICE: This drawing is subject to change.
 Revisions, if applicable, are available at www.saami.org.

ISSUED: 04/21/1980 **38-55 WINCHESTER [38-55 WIN]** REVISED: 02/10/2023

CARTRIDGE

UNLESS OTHERWISE NOTED
 BODY DIA. -.008 (0.20)

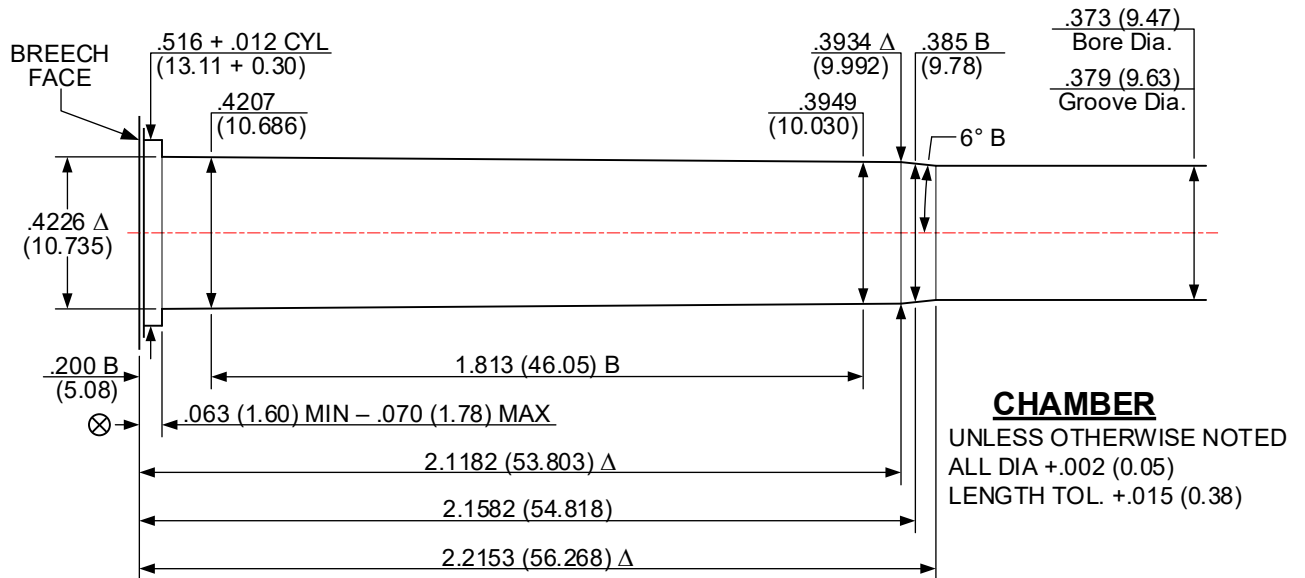
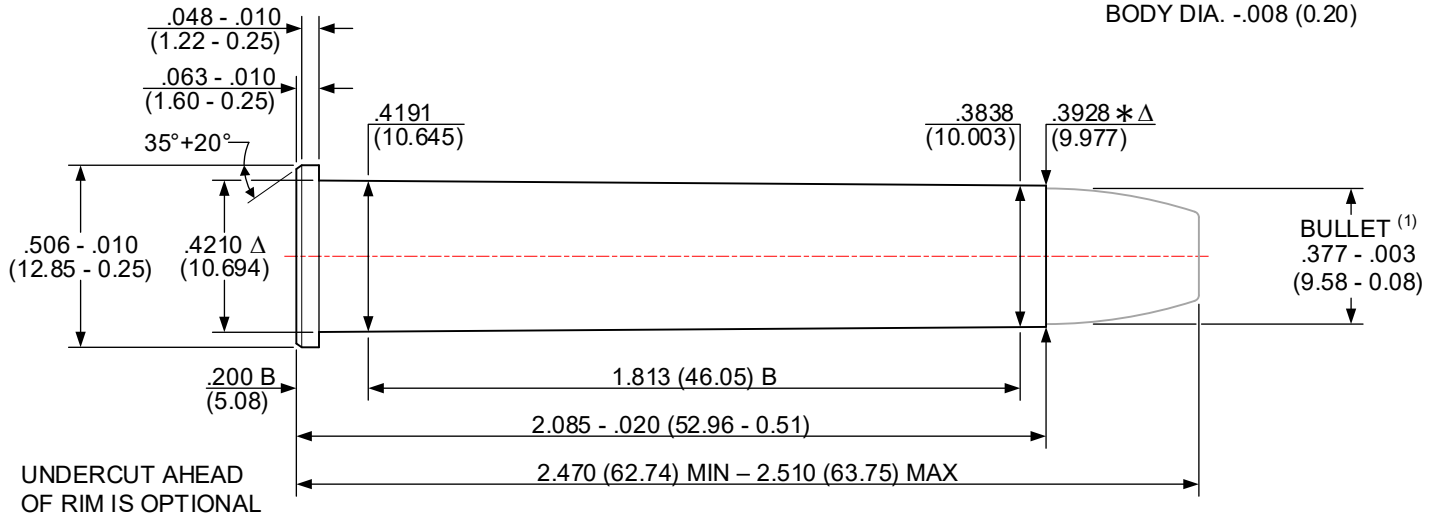

Δ 6 GROOVES
 Δ .1171+.0020 (2.974+0.051) WIDE

TWIST: 18.00 (457.2) R.H. OPTIONAL
 MINIMUM BORE & GROOVE AREA: .1114 in² (71.870 mm²)

NOTES:

- B = BASIC
- Δ = REFERENCE DIMENSION
- ALL CALCULATIONS APPLY AT MAXIMUM MATERIAL CONDITION (MMC)
- (1) – BULLET PROFILE IS SHOWN FOR ILLUSTRATIVE PURPOSES ONLY
- (XX.XX) = MILLIMETERS
- * = DIMENSIONS ARE TO INTERSECTION OF LINES
- ⊗ = HEADSPACE DIMENSION

DO NOT SCALE FROM DRAWING

ISSUED: 01/15/2023 **400 LEGEND [400 LGND]** REVISED: -/-/-/-/-

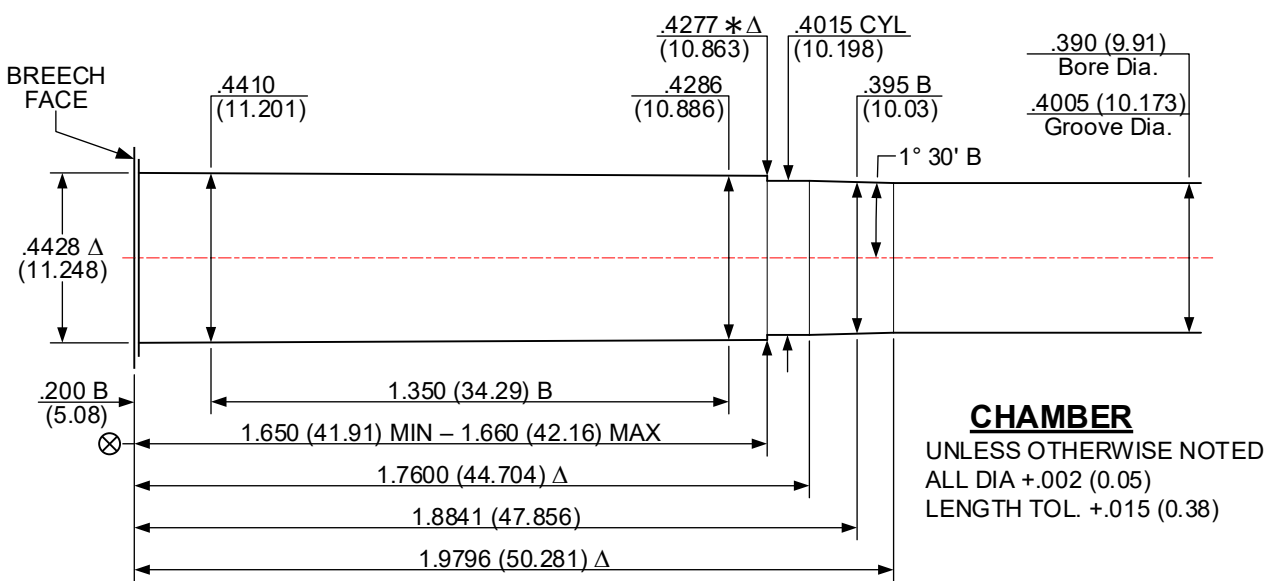
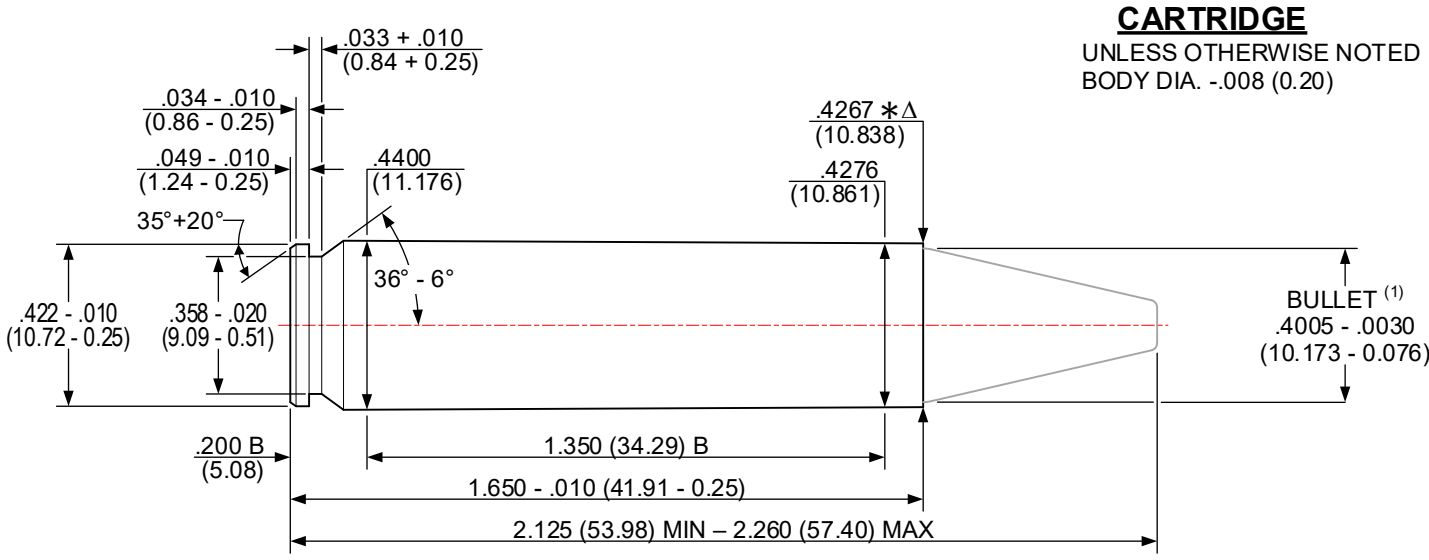

Δ 6 GROOVES TWIST: 16.00 (406.4) R.H. OPTIONAL
 Δ .120+.002 (3.05+0.05) WIDE MINIMUM BORE & GROOVE AREA: .1232 in² (79.483 mm²)

NOTES:
 B = BASIC (XX.XX) = MILLIMETERS ⊗ = HEADSPACE DIMENSION
 Δ = REFERENCE DIMENSION * = DIMENSIONS ARE TO INTERSECTION OF LINES
 ALL CALCULATIONS APPLY AT MAXIMUM MATERIAL CONDITION (MMC)
 (1) – BULLET PROFILE IS SHOWN FOR ILLUSTRATIVE PURPOSES ONLY

DO NOT SCALE FROM DRAWING

NOTICE: This drawing is subject to change.
 Revisions, if applicable, are available at www.saami.org.

ISSUED: 01/24/1998 **405 WINCHESTER [405 WIN]** REVISED: 02/10/2023

CARTRIDGE

UNLESS OTHERWISE NOTED
 BODY DIA. -.008 (0.20)

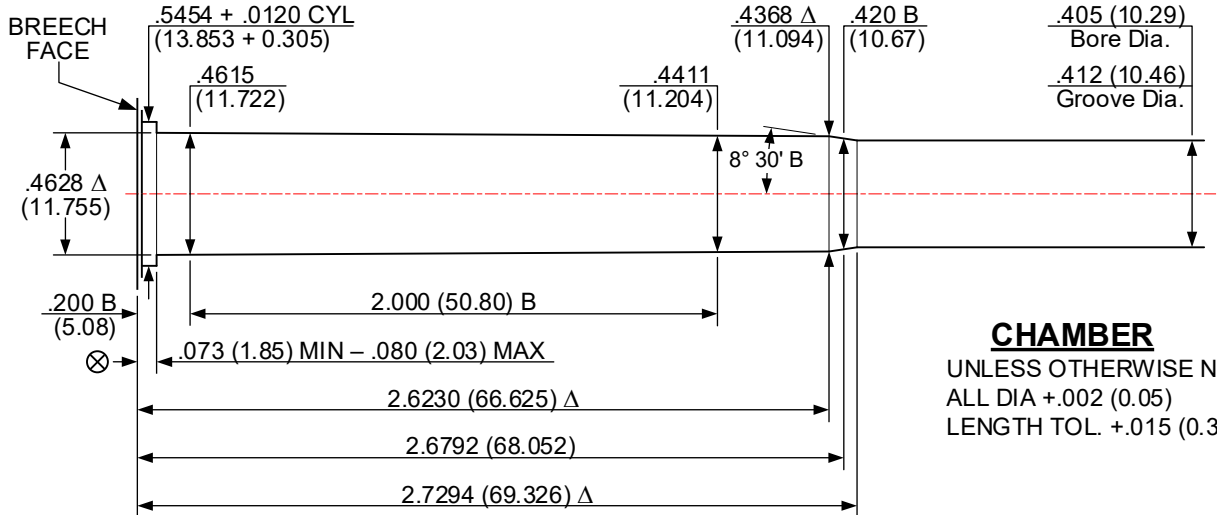
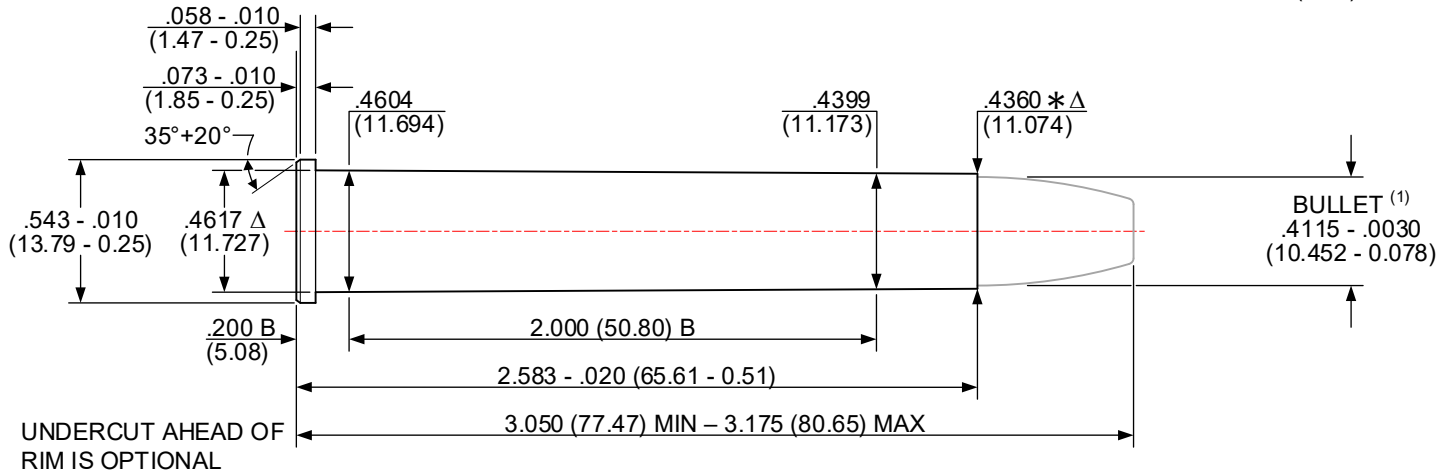

Δ 6 GROOVES TWIST: 14.00 (355.6) R.H. OPTIONAL
 Δ .127+.002 (3.23+0.05) WIDE MINIMUM BORE & GROOVE AREA: .1315 in² (84.838 mm²)

NOTES:

- B = BASIC (XX.XX) = MILLIMETERS ⊗ = HEADSPACE DIMENSION
- Δ = REFERENCE DIMENSION * = DIMENSIONS ARE TO INTERSECTION OF LINES
- ALL CALCULATIONS APPLY AT MAXIMUM MATERIAL CONDITION (MMC)
- (1) – BULLET PROFILE IS SHOWN FOR ILLUSTRATIVE PURPOSES ONLY

DO NOT SCALE FROM DRAWING

NOTICE: This drawing is subject to change.
 Revisions, if applicable, are available at www.saami.org.

ISSUED: 07/21/1989 **416 REMINGTON MAGNUM [416 REM MAG]** **REVISED: 08/15/2022**

CARTRIDGE
 UNLESS OTHERWISE NOTED
 BODY DIA. -.008 (0.20)

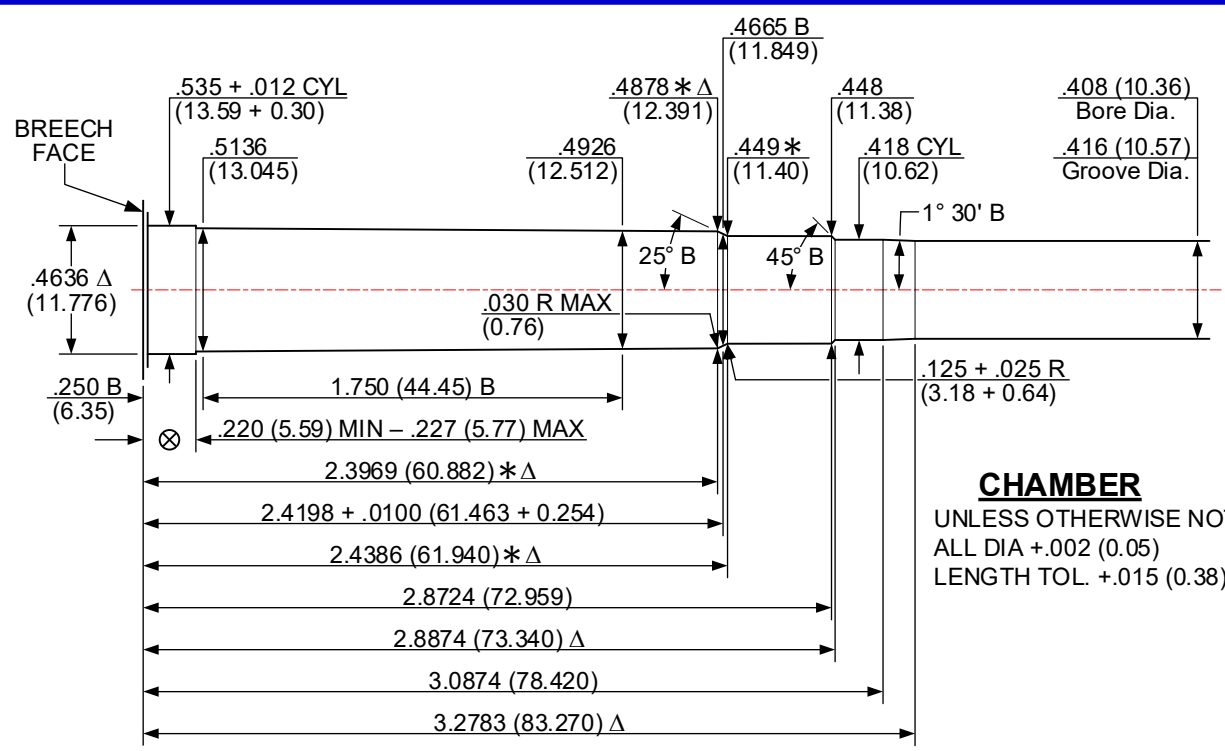
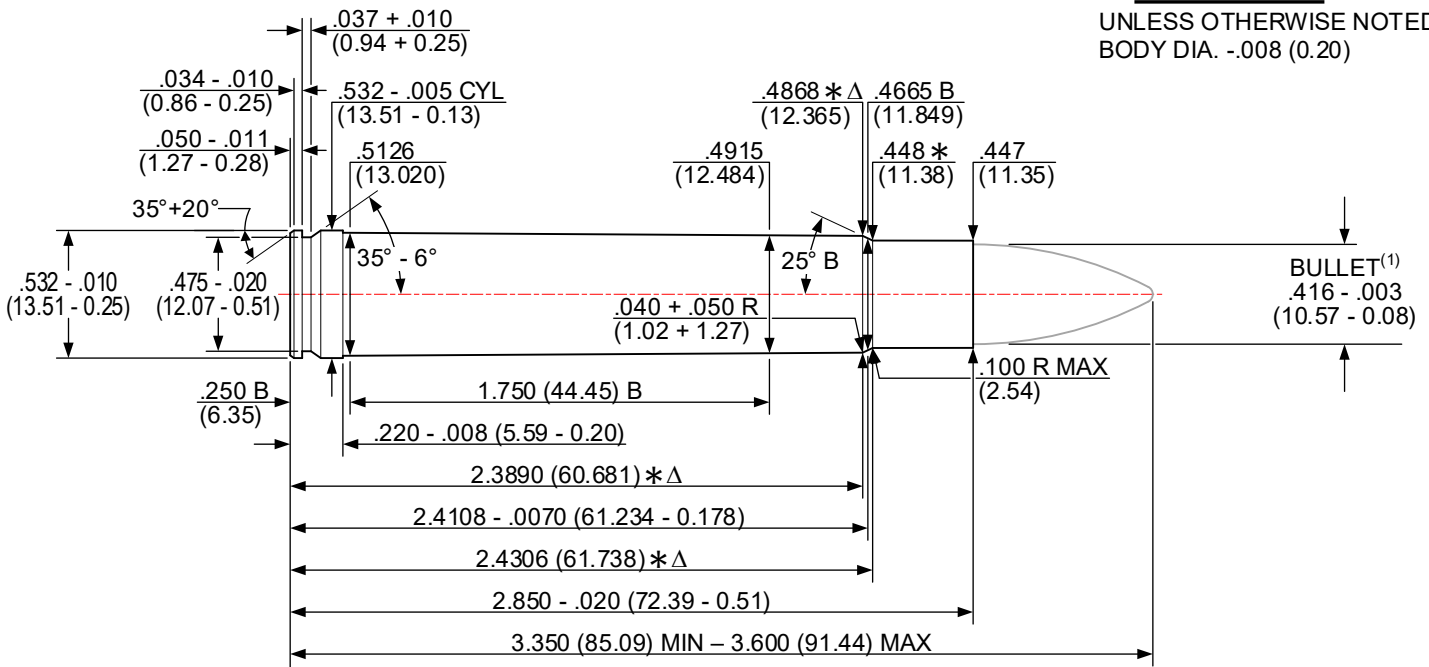

CHAMBER
 UNLESS OTHERWISE NOTED
 ALL DIA +.002 (0.05)
 LENGTH TOL. +.015 (0.38)

Δ 6 GROOVES TWIST: 14.00 (355.6) R.H. OPTIONAL
 Δ .128+.002 (3.25+0.05) WIDE MINIMUM BORE & GROOVE AREA: .1338 in² (86.322 mm²)

NOTES:
 B = BASIC (XX.XX) = MILLIMETERS ⊗ = HEADSPACE DIMENSION
 Δ = REFERENCE DIMENSION * = DIMENSIONS ARE TO INTERSECTION OF LINES

ALL CALCULATIONS APPLY AT MAXIMUM MATERIAL CONDITION (MMC)
 (1) – BULLET PROFILE IS SHOWN FOR ILLUSTRATIVE PURPOSES ONLY

DO NOT SCALE FROM DRAWING

NOTICE: This drawing is subject to change.
 Revisions, if applicable, are available at www.saami.org.

ISSUED: 09/08/1989 **416 RIGBY [416 RIGBY]** REVISED: 08/16/2022

CARTRIDGE

UNLESS OTHERWISE NOTED
 BODY DIA. -.008 (0.20)

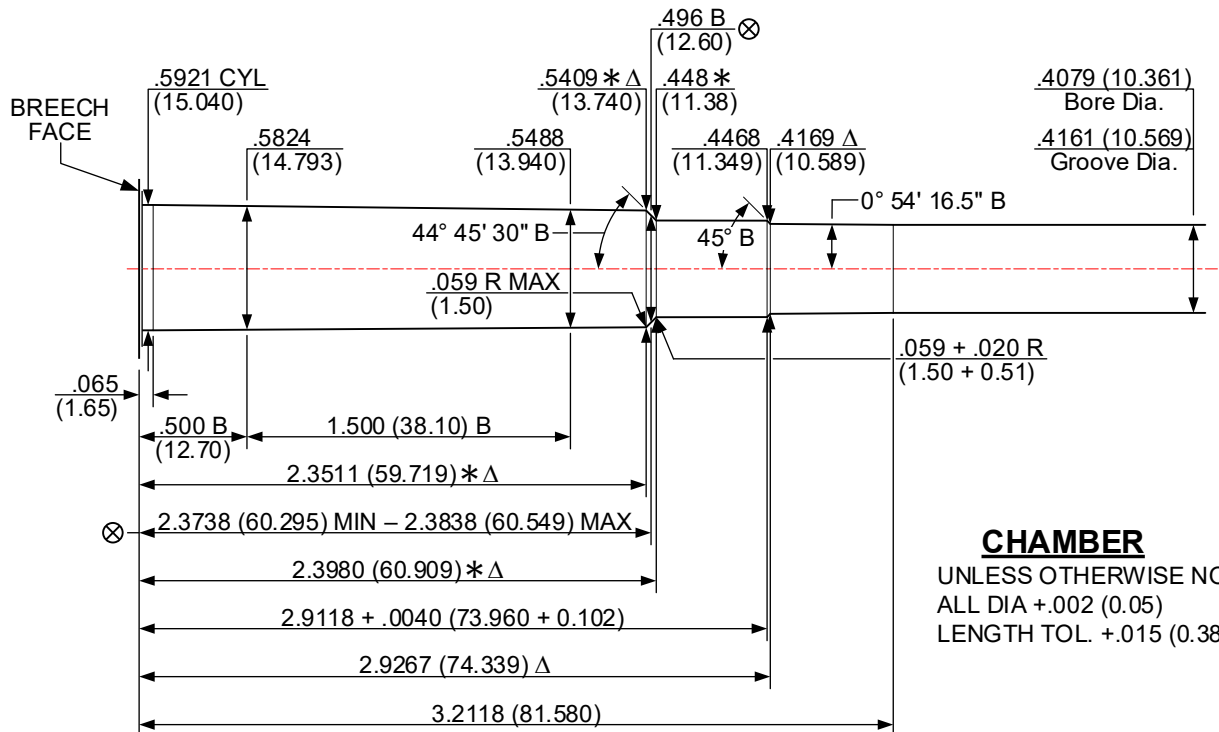
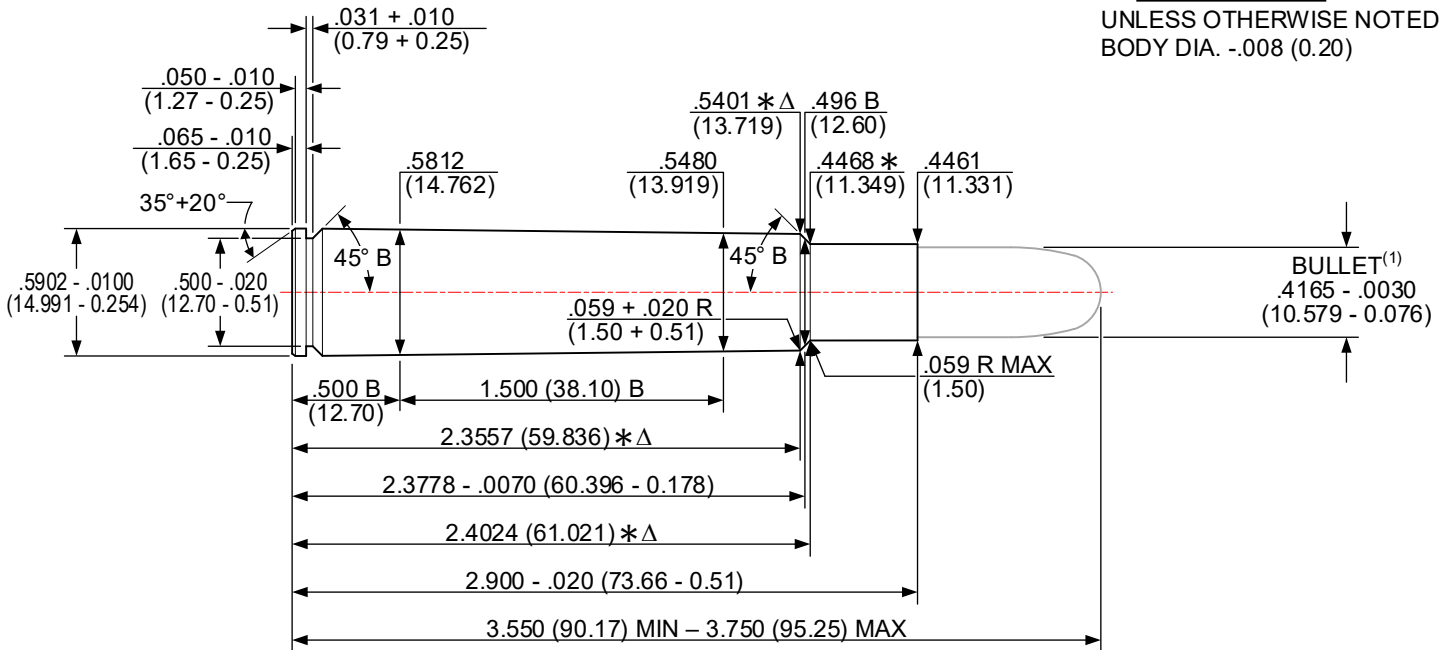

CHAMBER

UNLESS OTHERWISE NOTED
 ALL DIA +.002 (0.05)
 LENGTH TOL. +.015 (0.38)

Δ 6 GROOVES TWIST: 16.54 (420.0) R.H. OPTIONAL
 Δ .142+.002 (3.61+0.05) WIDE MINIMUM BORE & GROOVE AREA: .1342 in² (86.580 mm²)

NOTES:

- B = BASIC (XX.XX) = MILLIMETERS ⊗ = HEADSPACE DIMENSION
- Δ = REFERENCE DIMENSION * = DIMENSIONS ARE TO INTERSECTION OF LINES
- ALL CALCULATIONS APPLY AT MAXIMUM MATERIAL CONDITION (MMC)
- (1) – BULLET PROFILE IS SHOWN FOR ILLUSTRATIVE PURPOSES ONLY

DO NOT SCALE FROM DRAWING

NOTICE: This drawing is subject to change.
 Revisions, if applicable, are available at www.saami.org.

ISSUED: 06/17/2009

416 RUGER [416 RUGER]

REVISED: 08/17/2022

CARTRIDGE

UNLESS OTHERWISE NOTED
 BODY DIA. -.008 (0.20)

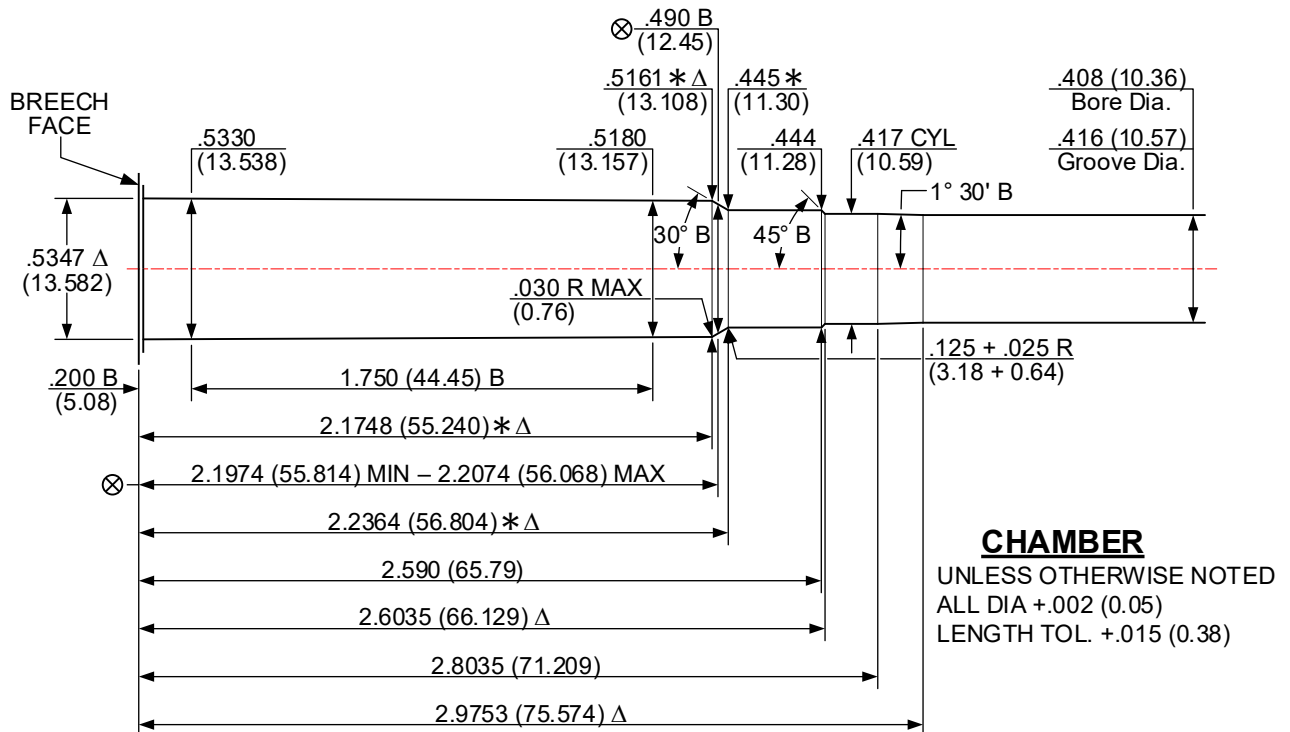
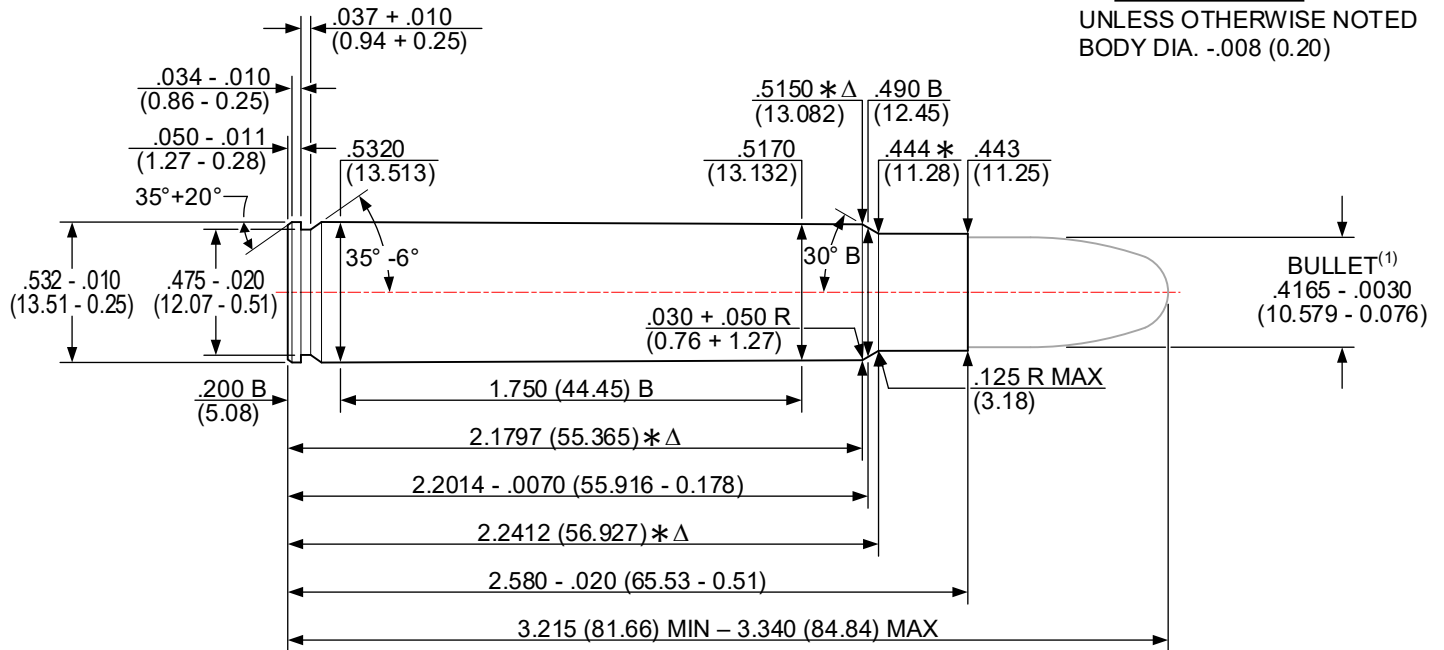

CHAMBER

UNLESS OTHERWISE NOTED
 ALL DIA +.002 (0.05)
 LENGTH TOL. +.015 (0.38)

Δ 6 GROOVES TWIST: 14.00 (355.6) R.H. OPTIONAL
 Δ .128+.002 (3.25+0.05) WIDE MINIMUM BORE & GROOVE AREA: .1338 in² (86.322 mm²)

NOTES:

- B = BASIC (XX.XX) = MILLIMETERS ⊗ = HEADSPACE DIMENSION
- Δ = REFERENCE DIMENSION * = DIMENSIONS ARE TO INTERSECTION OF LINES
- ALL CALCULATIONS APPLY AT MAXIMUM MATERIAL CONDITION (MMC)
- (1) – BULLET PROFILE IS SHOWN FOR ILLUSTRATIVE PURPOSES ONLY

DO NOT SCALE FROM DRAWING

NOTICE: This drawing is subject to change.
 Revisions, if applicable, are available at www.saami.org.

ISSUED: 01/12/1994

416 WEATHERBY MAGNUM [416 WB/MAG]

REVISED: 01/21/2024

CARTRIDGE

UNLESS OTHERWISE NOTED
 BODY DIA. -.004 (0.10)

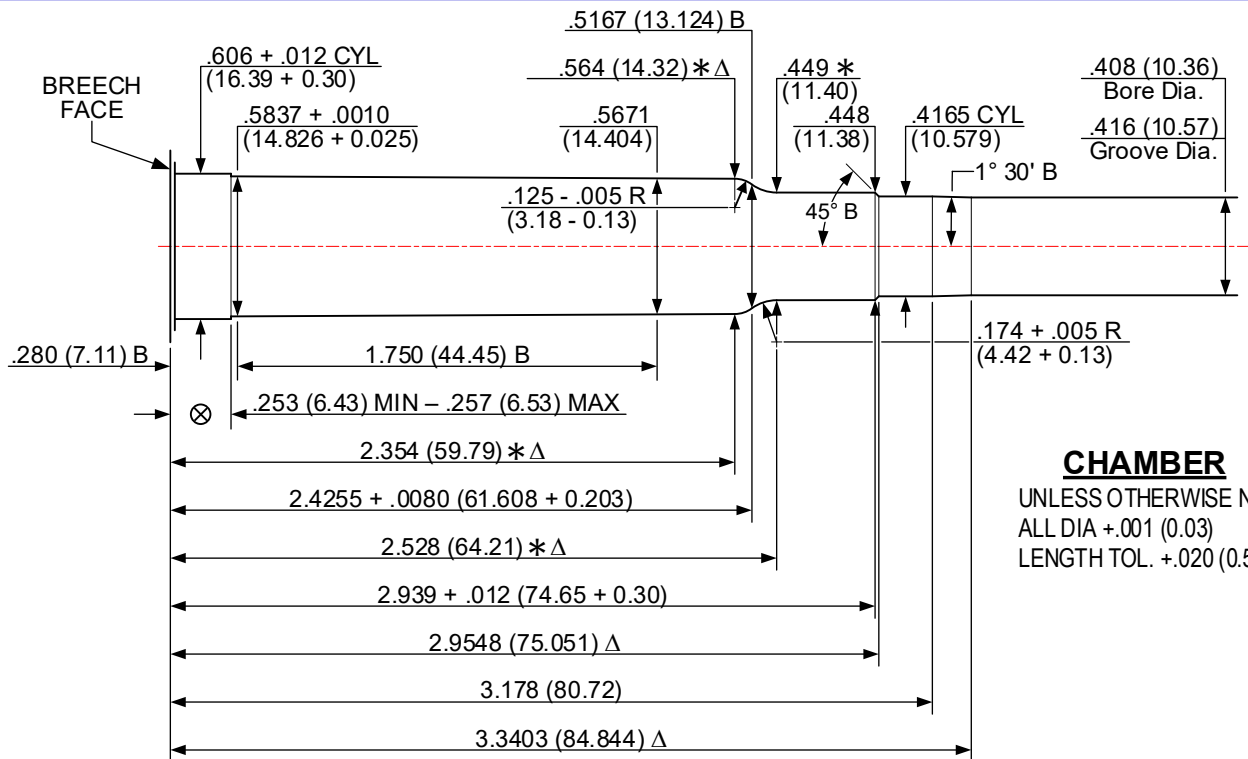
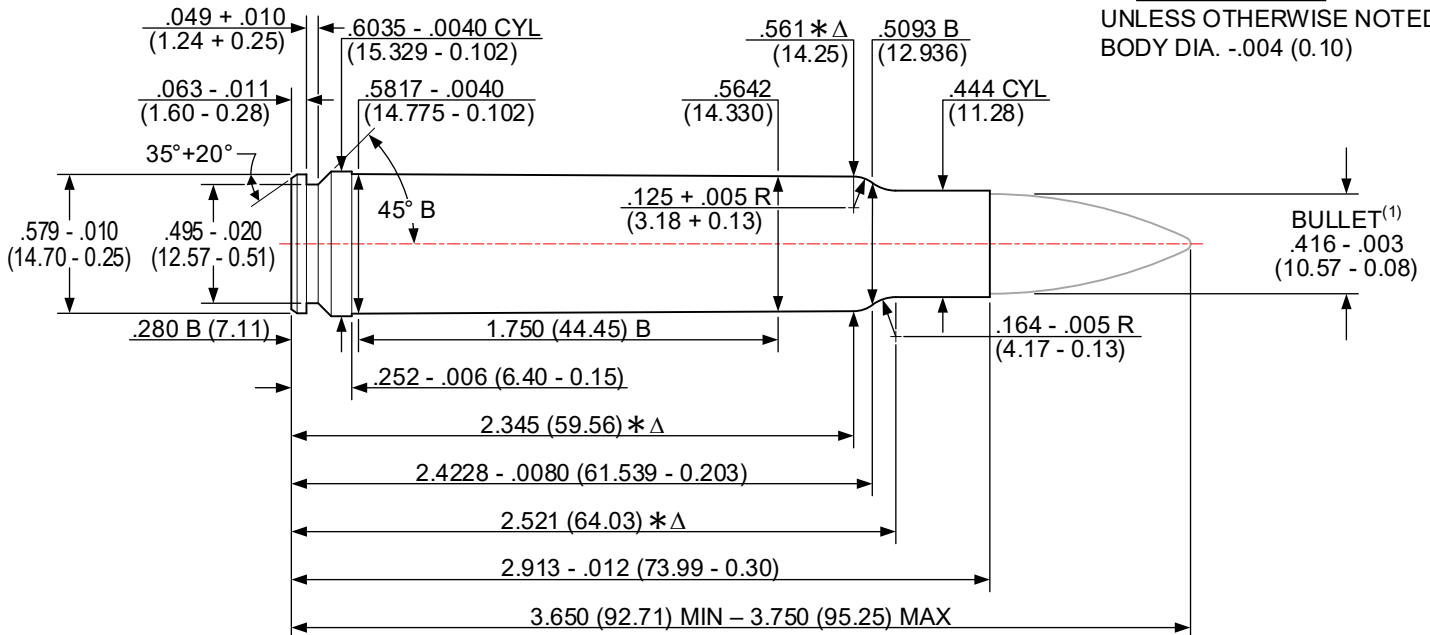

CHAMBER

UNLESS OTHERWISE NOTED
 ALL DIA +.001 (0.03)
 LENGTH TOL. +.020 (0.51)

Δ 6 GROOVES TWIST: 14.00 (355.6) R.H. OPTIONAL
 Δ .127+.002 (3.23+0.05) WIDE MINIMUM BORE & GROOVE AREA: .1338 in² (86.322 mm²)

NOTE:

B = BASIC (XX.XX) = MILLIMETERS ⊗ = HEADSPACE DIMENSION
 Δ = REFERENCE DIMENSION * = DIMENSIONS ARE TO INTERSECTION OF LINES
 ALL CALCULATIONS APPLY AT MAXIMUM MATERIAL CONDITION (MMC)
 (1) – BULLET PROFILE IS SHOWN FOR ILLUSTRATIVE PURPOSES ONLY

DO NOT SCALE FROM DRAWING

44 REMINGTON MAGNUM [44 REM MAG]
RIFLE

ISSUED: 05/29/1979

REVISED: 02/10/2023

CARTRIDGE

UNLESS OTHERWISE NOTED
 BODY DIA. -.005 (0.13)

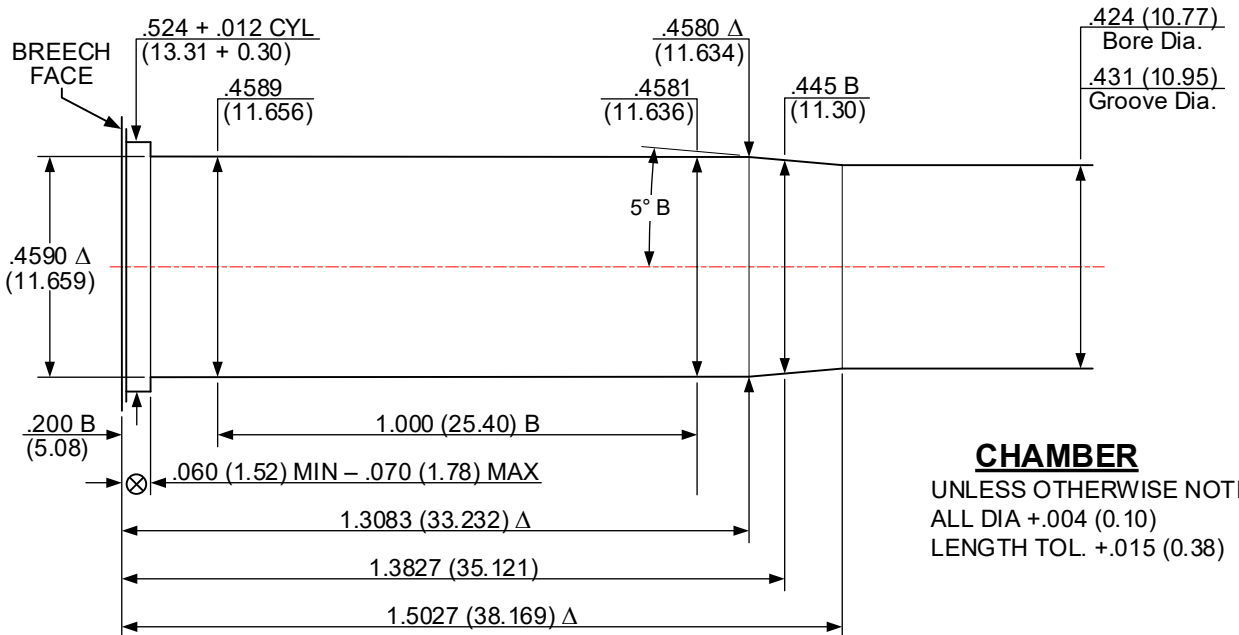
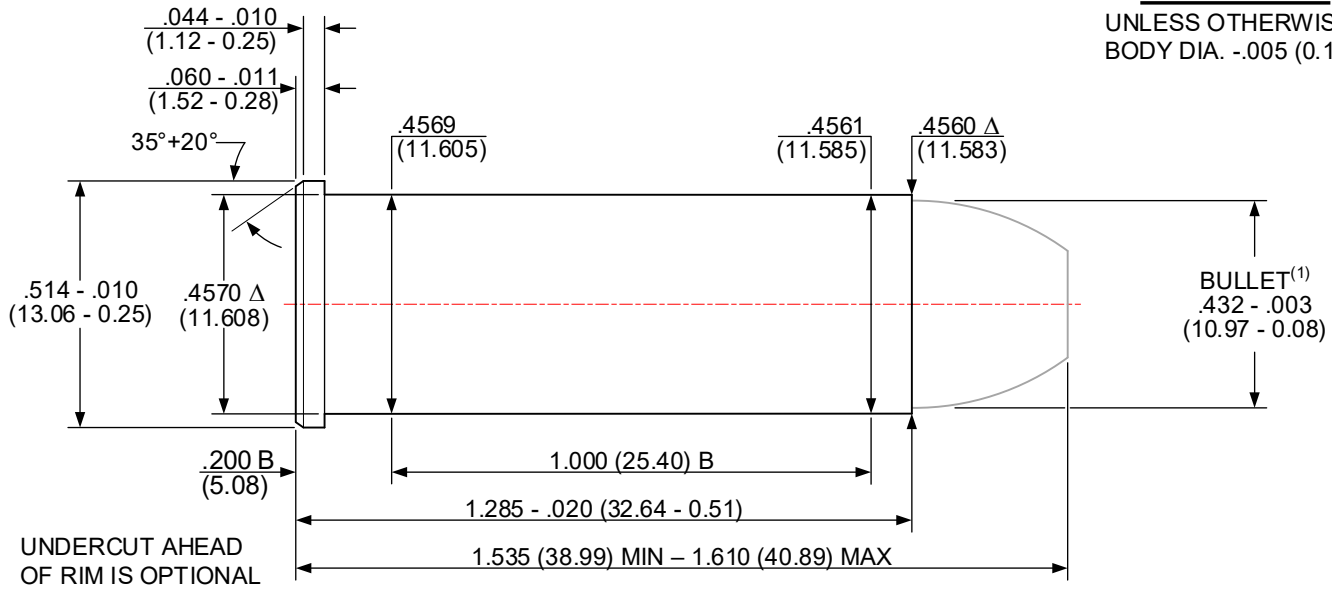

Δ 12 GROOVES
 Δ .055+.002 (1.40+0.05) WIDE

TWIST: 38.00 (965.2) R.H. OPTIONAL
 MIN. BORE & GROOVE AREA: .1435 in² (92.580 mm²)

NOTES:

- B = BASIC
- Δ = REFERENCE DIMENSION
- ALL CALCULATIONS APPLY AT MAXIMUM MATERIAL CONDITION (MMC)
- (1) – BULLET PROFILE IS SHOWN FOR ILLUSTRATIVE PURPOSES ONLY
- (XX.XX) = MILLIMETERS
- * = DIMENSIONS ARE TO INTERSECTION OF LINES
- ⊗ = HEAD SPACE DIMENSION

DO NOT SCALE FROM DRAWING

ISSUED: 05/29/1979 **44-40 WINCHESTER [44-40 WIN]** REVISED: 02/10/2023

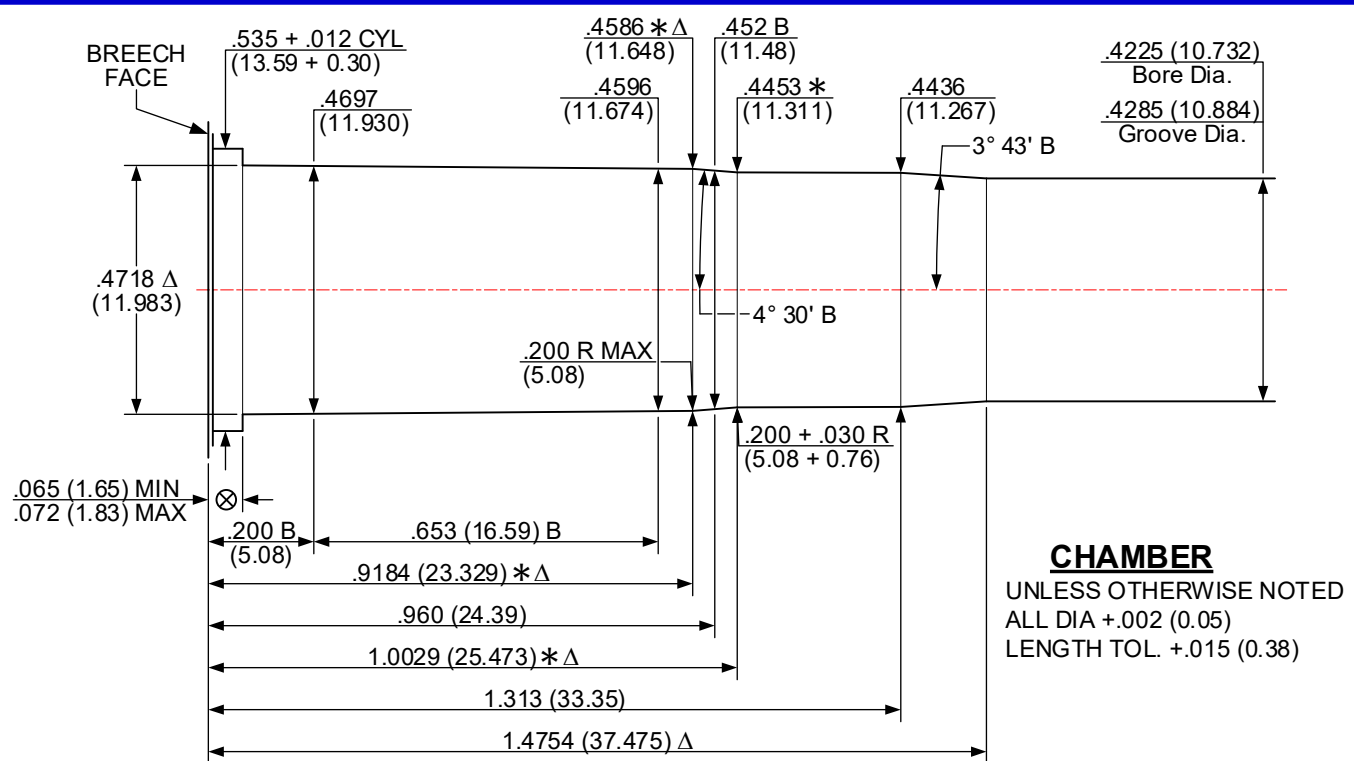
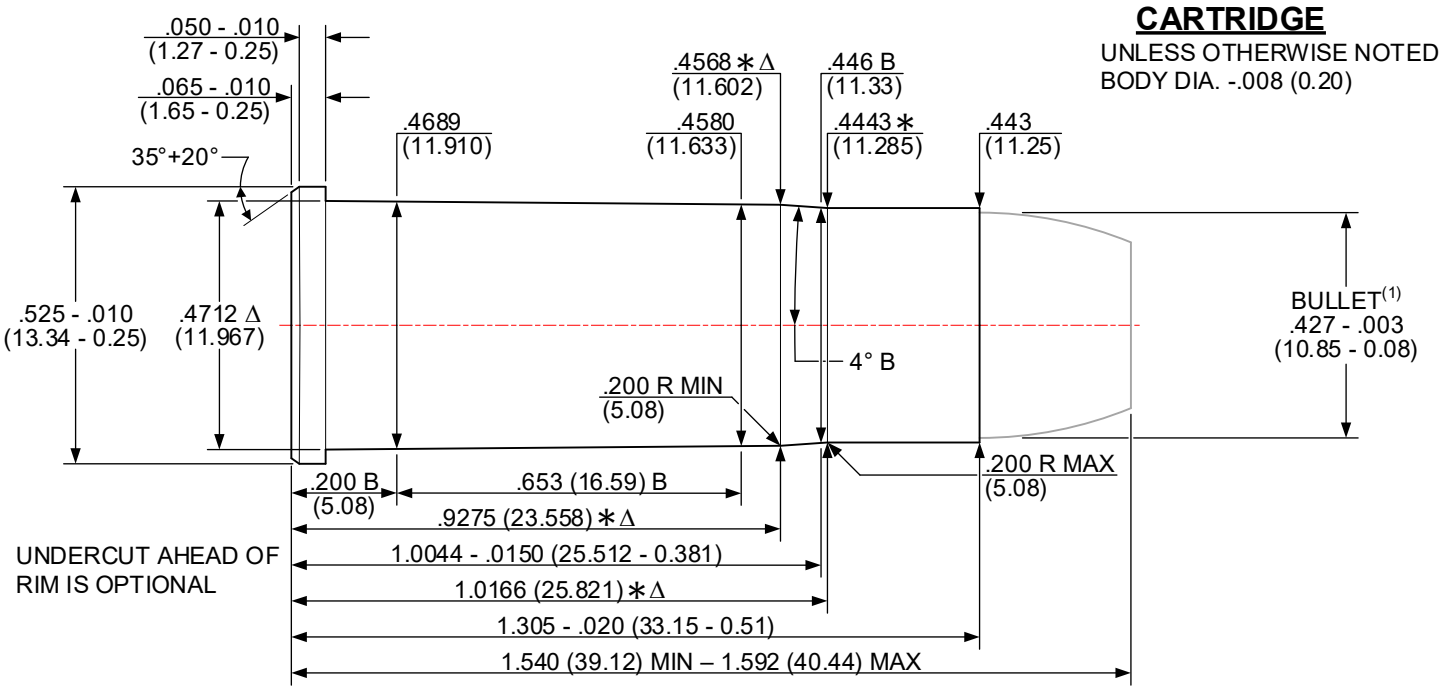

NOTES:
 B = BASIC (XX.XX) = MILLIMETERS ⊗ = HEAD SPACE DIMENSION
 △ = REFERENCE DIMENSION * = DIMENSIONS ARE TO INTERSECTION OF LINES
 ALL CALCULATIONS APPLY AT MAXIMUM MATERIAL CONDITION (MMC)
 (1) – BULLET PROFILE IS SHOWN FOR ILLUSTRATIVE PURPOSES ONLY

DO NOT SCALE FROM DRAWING

ISSUED: 05/29/1979

444 MARLIN [444 MAR]

REVISED: 02/10/2023

CARTRIDGE

UNLESS OTHERWISE NOTED
 BODY DIA. -.008 (0.20)

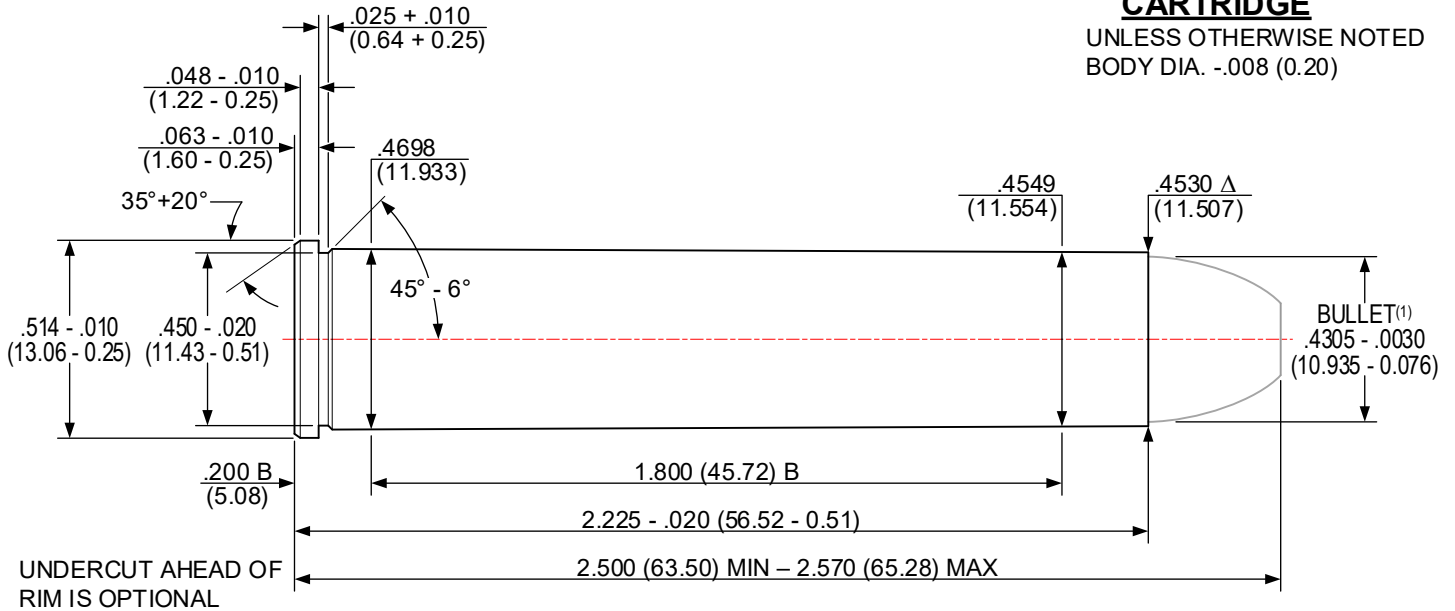

CHAMBER

UNLESS OTHERWISE NOTED
 ALL DIA +.002 (0.10)
 LENGTH TOL. +.015 (0.38)

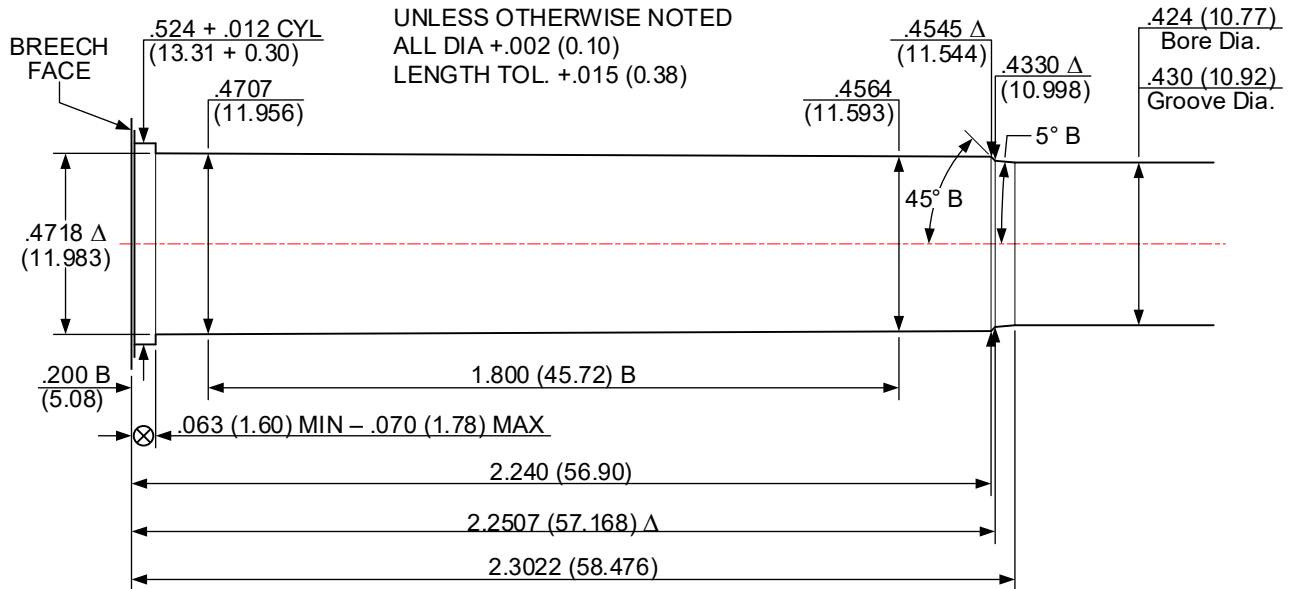

Δ 12 GROOVES TWIST: 38.00 (965.2) R.H. OPTIONAL
 Δ .062+.002 (1.57+0.05) WIDE MINIMUM BORE & GROOVE AREA: .1434 in² (92.515 mm²)

NOTES:

- B = BASIC (XX.XX) = MILLIMETERS \otimes = HEAD SPACE DIMENSION
- Δ = REFERENCE DIMENSION * = DIMENSIONS ARE TO INTERSECTION OF LINES
- ALL CALCULATIONS APPLY AT MAXIMUM MATERIAL CONDITION (MMC)
- (1) – BULLET PROFILE IS SHOWN FOR ILLUSTRATIVE PURPOSES ONLY

DO NOT SCALE FROM DRAWING

ISSUED: 05/29/1979 **45-70 GOVERNMENT [45-70 GOVT]** REVISED: 02/10/2023

CARTRIDGE

UNLESS OTHERWISE NOTED
 BODY DIA. -.008 (0.20)

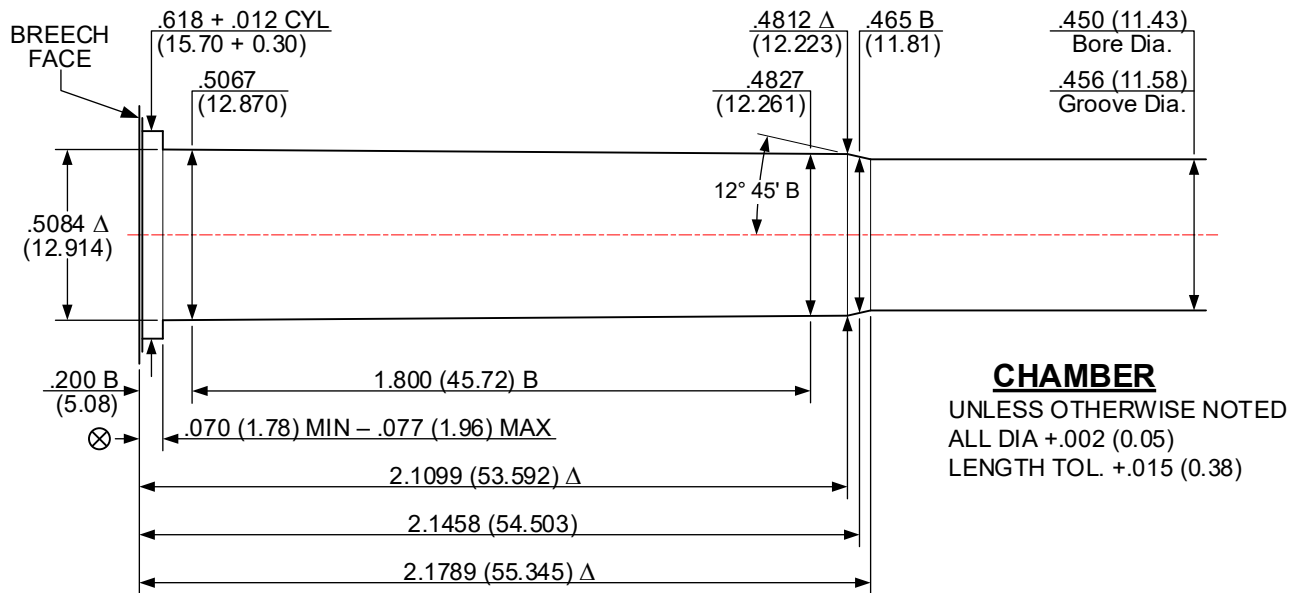
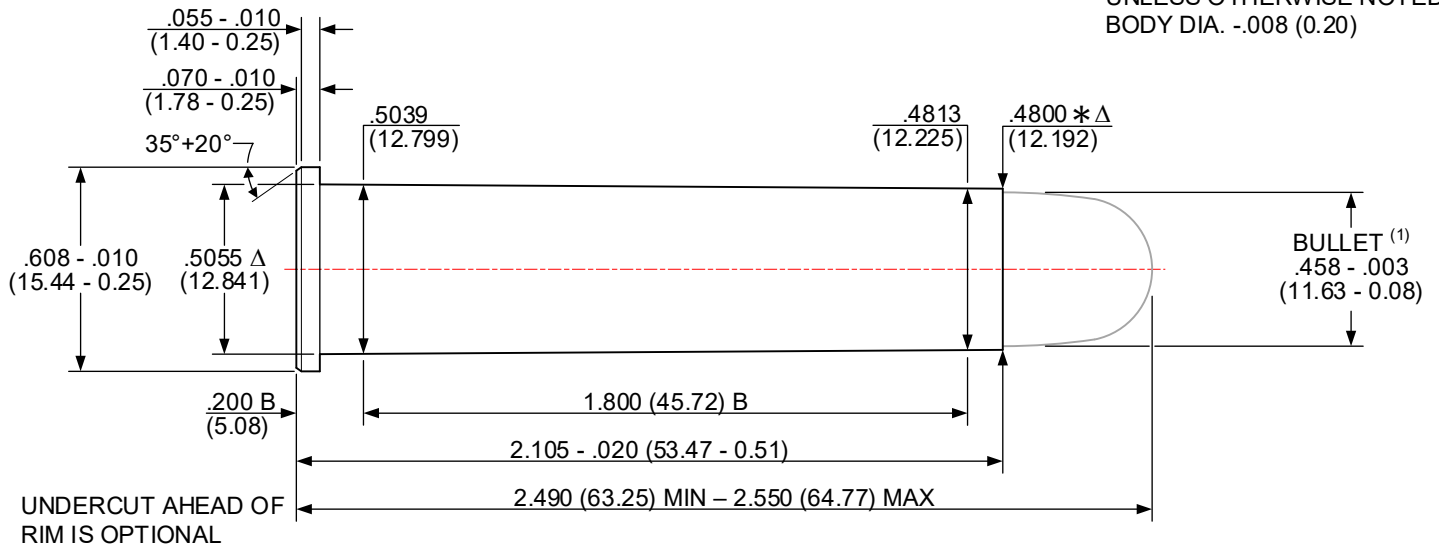

Δ 6 GROOVES TWIST: 20.00 (508.0) R.H. OPTIONAL
 Δ .141+.002 (3.58+0.05) WIDE MINIMUM BORE & GROOVE AREA: .1616 in² (104.257 mm²)

NOTES:

- B = BASIC (XX.XX) = MILLIMETERS ⊗ = HEADSPACE DIMENSION
- Δ = REFERENCE DIMENSION * = DIMENSIONS ARE TO INTERSECTION OF LINES
- ALL CALCULATIONS APPLY AT MAXIMUM MATERIAL CONDITION (MMC)
- (1) – BULLET PROFILE IS SHOWN FOR ILLUSTRATIVE PURPOSES ONLY

DO NOT SCALE FROM DRAWING

NOTICE: This drawing is subject to change.
 Revisions, if applicable, are available at www.saami.org.

ISSUED: 02/01/2008 **450 BUSHMASTER [450 BM]** REVISED: 08/23/2022

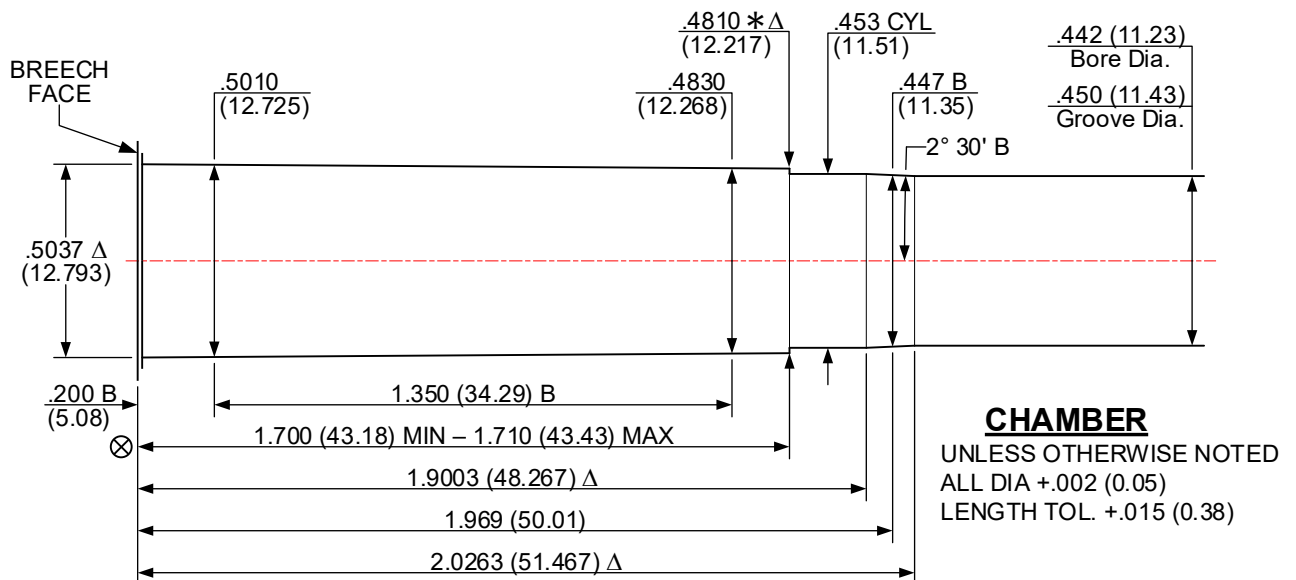
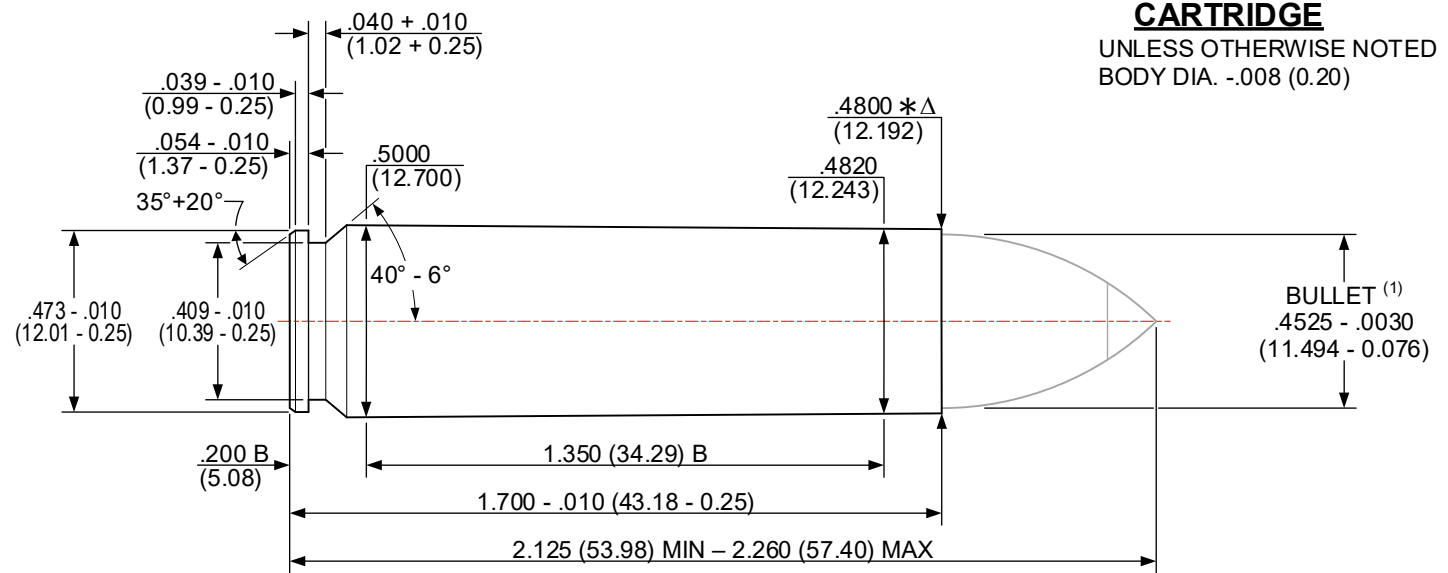

Δ 6 GROOVES
 Δ .148+.002 (3.76+0.05) WIDE TWIST: 24.00 (609.6) R.H. OPTIONAL
 MINIMUM BORE & GROOVE AREA: .1570 in² (101.290 mm²)

NOTES:

B = BASIC (XX.XX) = MILLIMETERS \otimes = HEADSPACE DIMENSION
 Δ = REFERENCE DIMENSION * = DIMENSIONS ARE TO INTERSECTION OF LINES
 ALL CALCULATIONS APPLY AT MAXIMUM MATERIAL CONDITION (MMC)
 (1) – BULLET PROFILE IS SHOWN FOR ILLUSTRATIVE PURPOSES ONLY

DO NOT SCALE FROM DRAWING

NOTICE: This drawing is subject to change.
 Revisions, if applicable, are available at www.saami.org.

ISSUED: 01/10/2001 **450 MARLIN [450 MARLIN]** REVISED: 08/23/2022

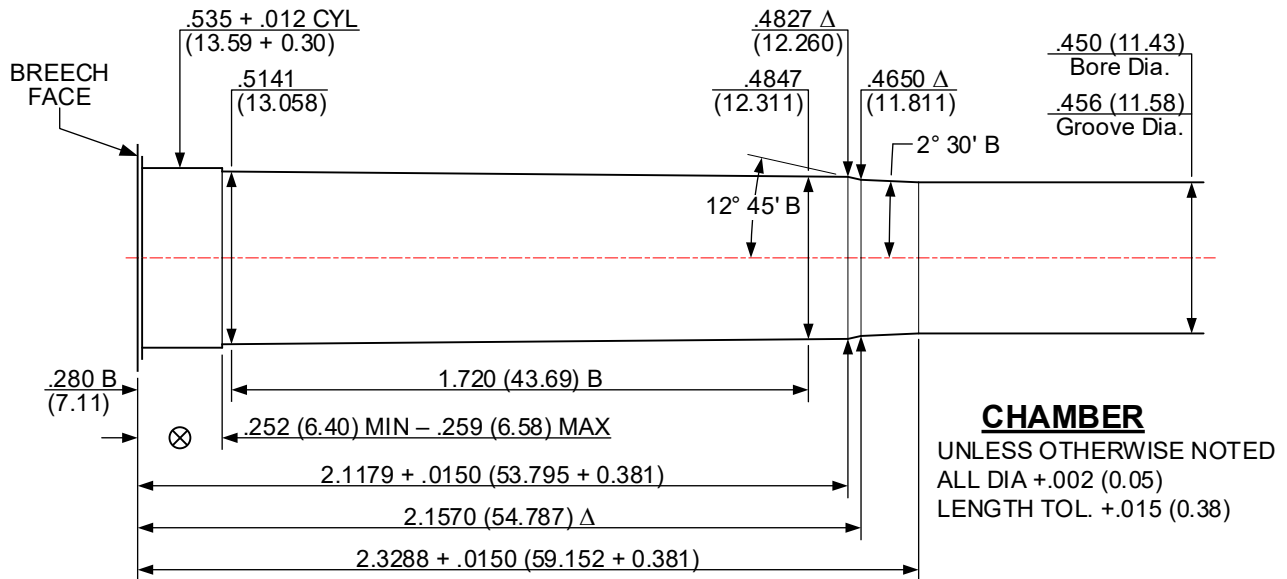
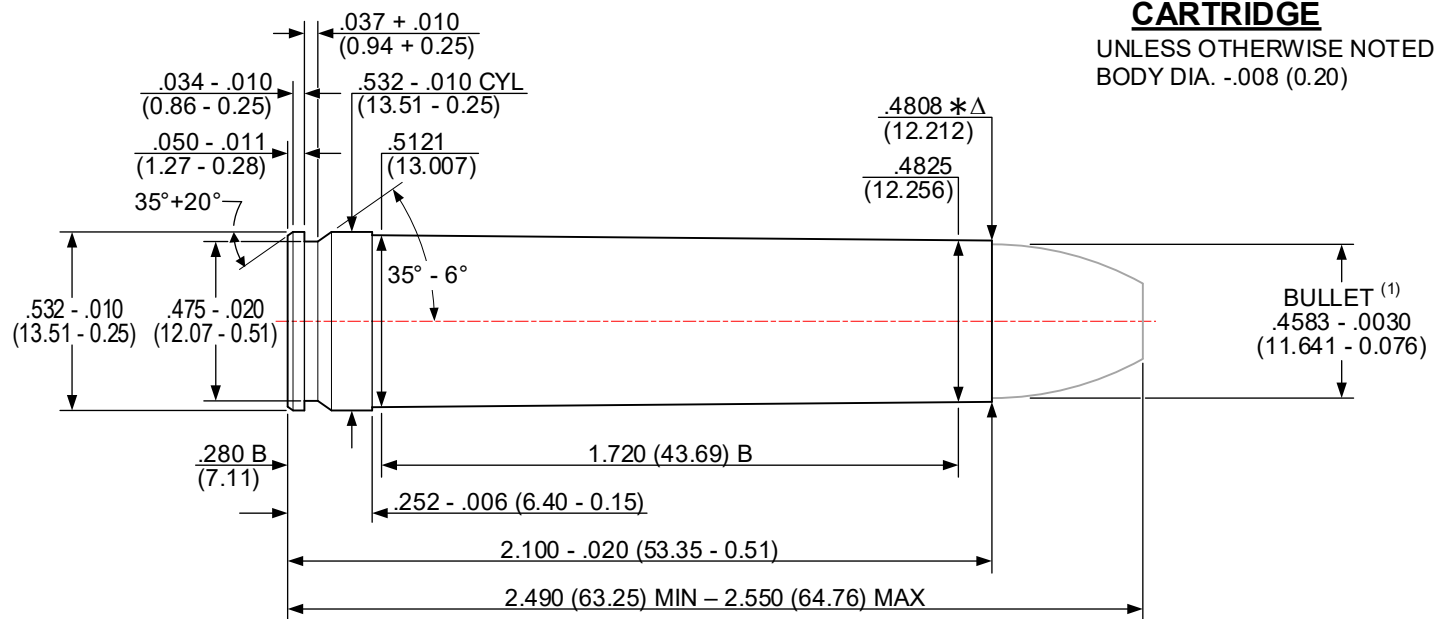

Δ 6 GROOVES TWIST: 20.00 (508.0) R.H. OPTIONAL
 Δ .141+.002 (3.76+0.05) WIDE MINIMUM BORE & GROOVE AREA: .1616 in² (104.257 mm²)

NOTES:

- B = BASIC (XX.XX) = MILLIMETERS ⊗ = HEADSPACE DIMENSION
- Δ = REFERENCE DIMENSION * = DIMENSIONS ARE TO INTERSECTION OF LINES
- ALL CALCULATIONS APPLY AT MAXIMUM MATERIAL CONDITION (MMC)
- (1) – BULLET PROFILE IS SHOWN FOR ILLUSTRATIVE PURPOSES ONLY

DO NOT SCALE FROM DRAWING

NOTICE: This drawing is subject to change.
 Revisions, if applicable, are available at www.saami.org.

ISSUED: 06/04/1998 **458 LOTT [458 LOTT]** REVISED: 01/21/2024

CARTRIDGE

UNLESS OTHERWISE NOTED
 BODY DIA. -.008 (0.20)

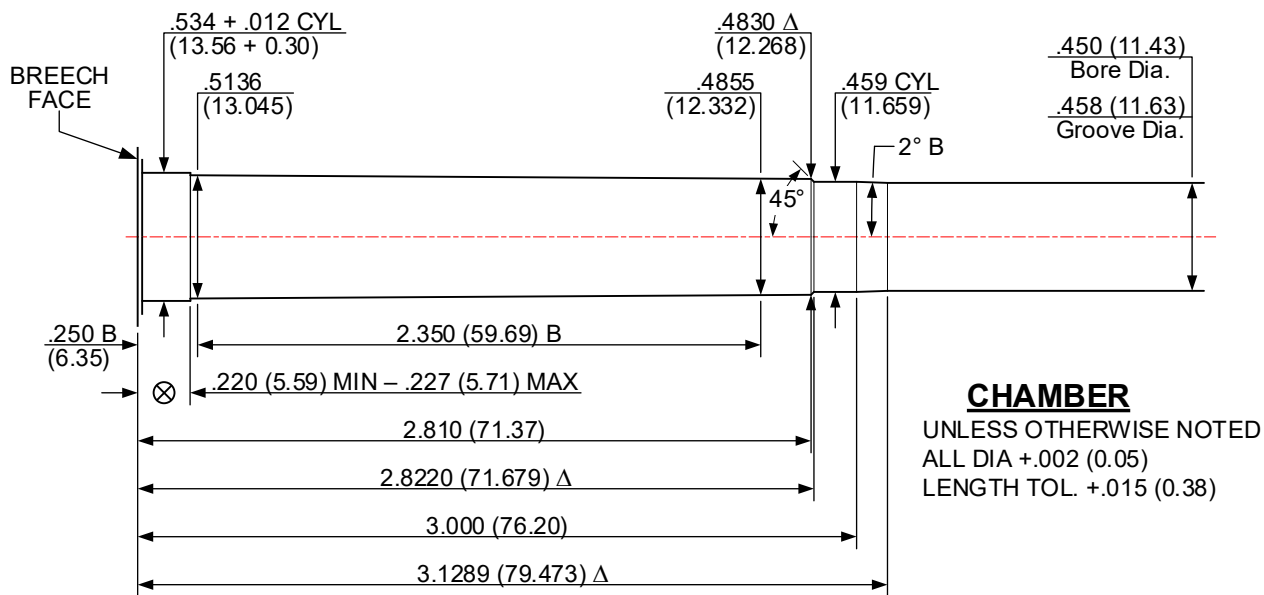
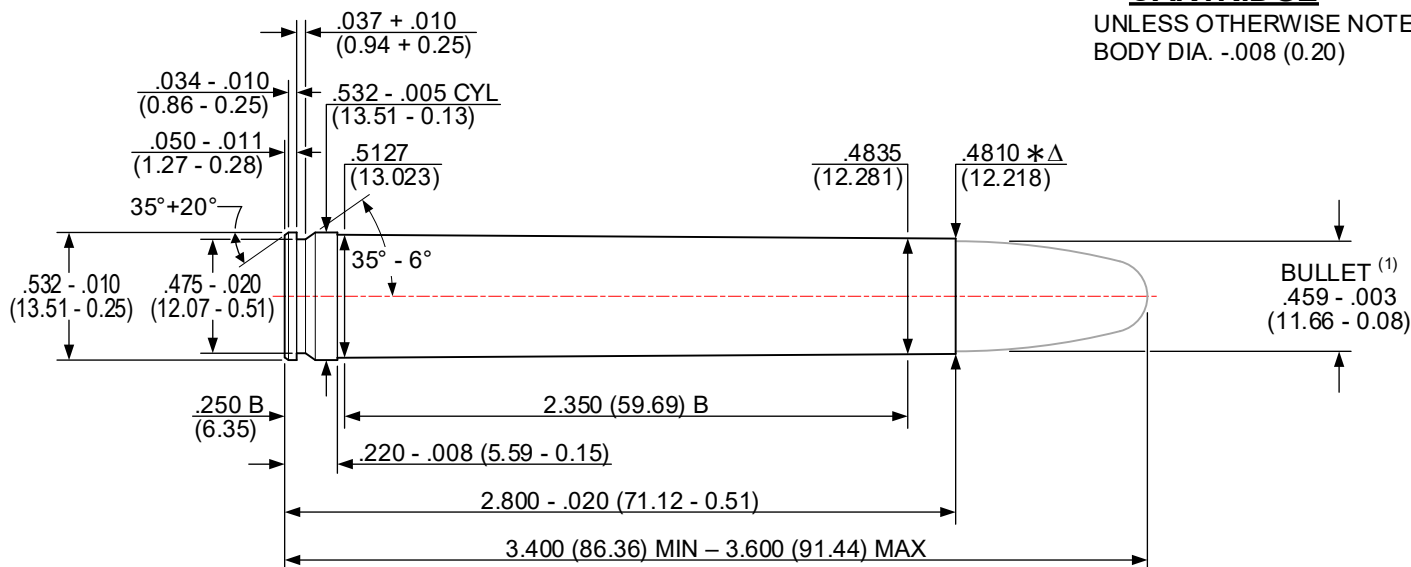

CHAMBER

UNLESS OTHERWISE NOTED
 ALL DIA +.002 (0.05)
 LENGTH TOL. +.015 (0.38)

Δ 6 GROOVES TWIST: 10.00 (254.0) R.H. OPTIONAL
 Δ .150+.002 (3.81+0.05) WIDE MINIMUM BORE & GROOVE AREA: .1627 in² (104.967 mm²)

NOTES:

- B = BASIC (XX.XX) = MILLIMETERS ⊗ = HEADSPACE DIMENSION
- Δ = REFERENCE DIMENSION * = DIMENSIONS ARE TO INTERSECTION OF LINES
- ALL CALCULATIONS APPLY AT MAXIMUM MATERIAL CONDITION (MMC)
- (1) – BULLET PROFILE IS SHOWN FOR ILLUSTRATIVE PURPOSES ONLY

DO NOT SCALE FROM DRAWING

ISSUED: 04/21/1980 **458 WINCHESTER MAGNUM [458 WIN MAG]** REVISED: 02/22/2023

CARTRIDGE

UNLESS OTHERWISE NOTED
 BODY DIA. -.008 (0.20)

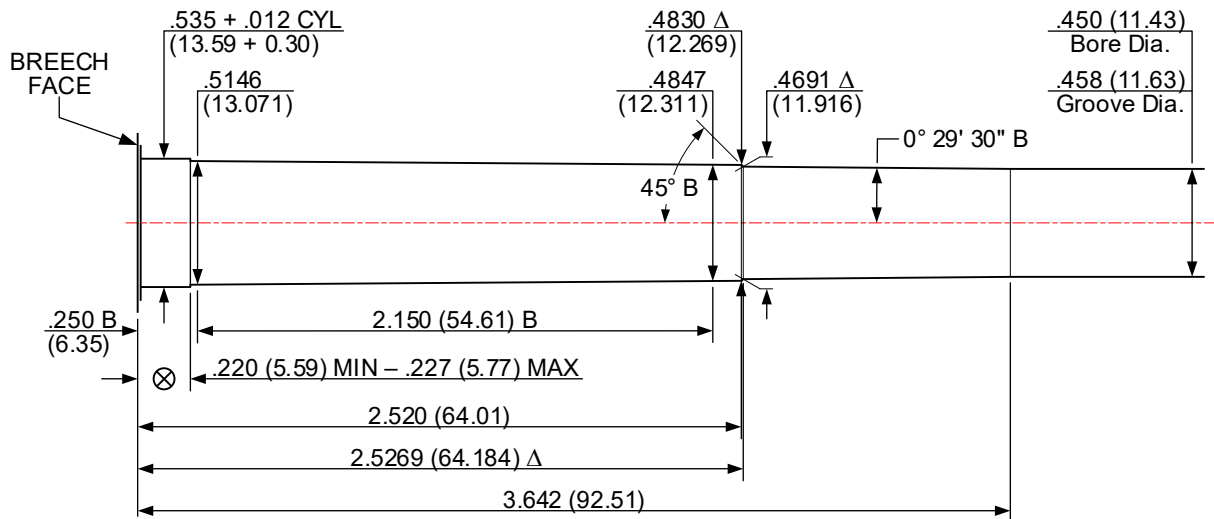
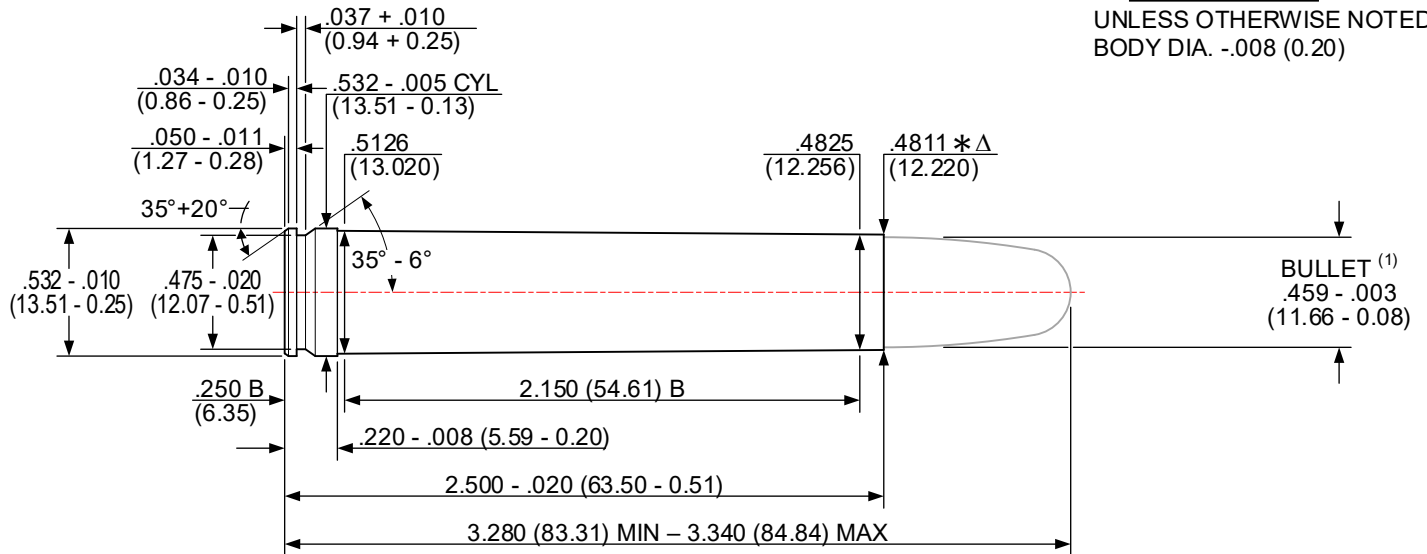

CHAMBER

UNLESS OTHERWISE NOTED
 ALL DIA +.002 (0.05)
 LENGTH TOL. +.015 (0.38)

△ 6 GROOVES TWIST: 14.00 (355.6) R.H. OPTIONAL
 △ .150+.002 (3.81+0.05) WIDE MINIMUM BORE & GROOVE AREA: .1627 in² (104.967 mm²)

NOTES:

- B = BASIC (XX.XX) = MILLIMETERS ⊗ = HEADSPACE DIMENSION
- △ = REFERENCE DIMENSION * = DIMENSIONS ARE TO INTERSECTION OF LINES
- ALL CALCULATIONS APPLY AT MAXIMUM MATERIAL CONDITION (MMC)
- (1) – BULLET PROFILE IS SHOWN FOR ILLUSTRATIVE PURPOSES ONLY

DO NOT SCALE FROM DRAWING

NOTICE: This drawing is subject to change.
 Revisions, if applicable, are available at www.saami.org.

ISSUED: 09/08/1989

470 NITRO EXPRESS [470 NE]

REVISED: 02/10/2023

CARTRIDGE

UNLESS OTHERWISE NOTED
 BODY DIA. -.008 (0.20)

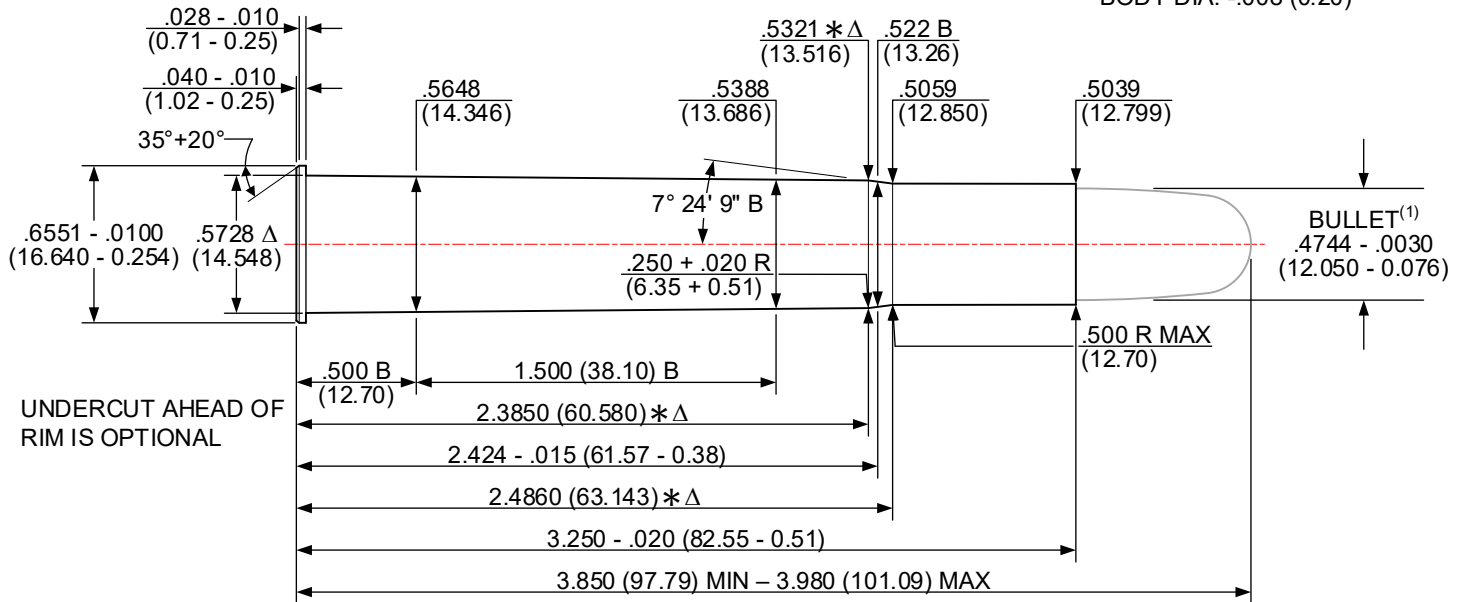

CHAMBER

UNLESS OTHERWISE NOTED
 ALL DIA +.002 (0.05)
 LENGTH TOL. +.015 (0.38)

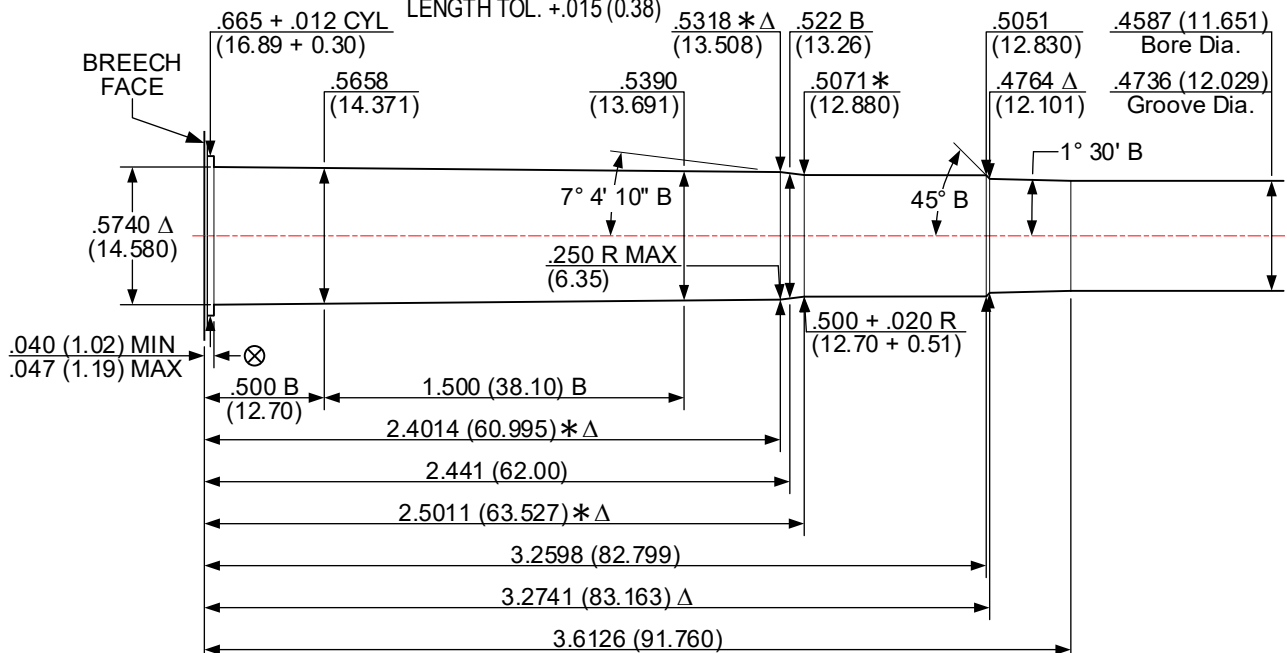

Δ 6 GROOVES TWIST: 20.00 (508.0) R.H. OPTIONAL
 Δ .160 +.002 (4.06+0.05) WIDE MINIMUM BORE & GROOVE AREA: .1725 in² (111.290 mm²)

NOTES:

- B = BASIC (XX.XX) = MILLIMETERS ⊗ = HEAD SPACE DIMENSION
- Δ = REFERENCE DIMENSION * = DIMENSIONS ARE TO INTERSECTION OF LINES
- ALL CALCULATIONS APPLY AT MAXIMUM MATERIAL CONDITION (MMC)
- (1) – BULLET PROFILE IS SHOWN FOR ILLUSTRATIVE PURPOSES ONLY

DO NOT SCALE FROM DRAWING

ISSUED: 02/24/2016 **500 NITRO EXPRESS 3" [500 NE 3"]** **REVISED: 02/10/2023**

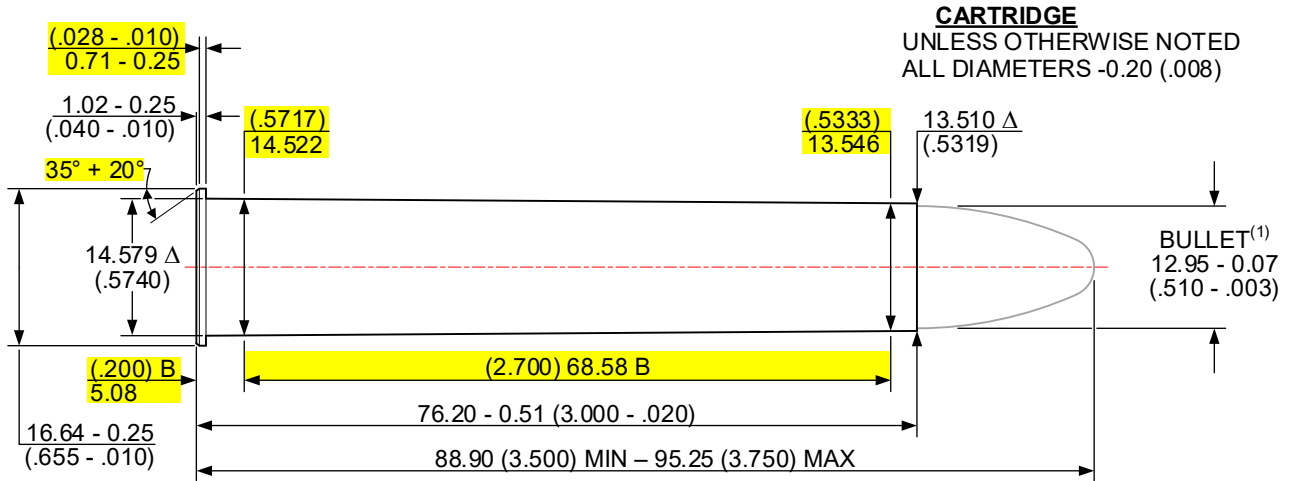

UNDERCUT AHEAD OF RIM IS OPTIONAL

HIGHLIGHTED DIMENSIONS HAVE NO CORRESPONDING C.I.P. ANALOG. THE ENGLISH UNITS FOR THESE ARE THE ORIGINAL VALUES; METRIC VALUES ARE CALCULATED AND ROUNDED.

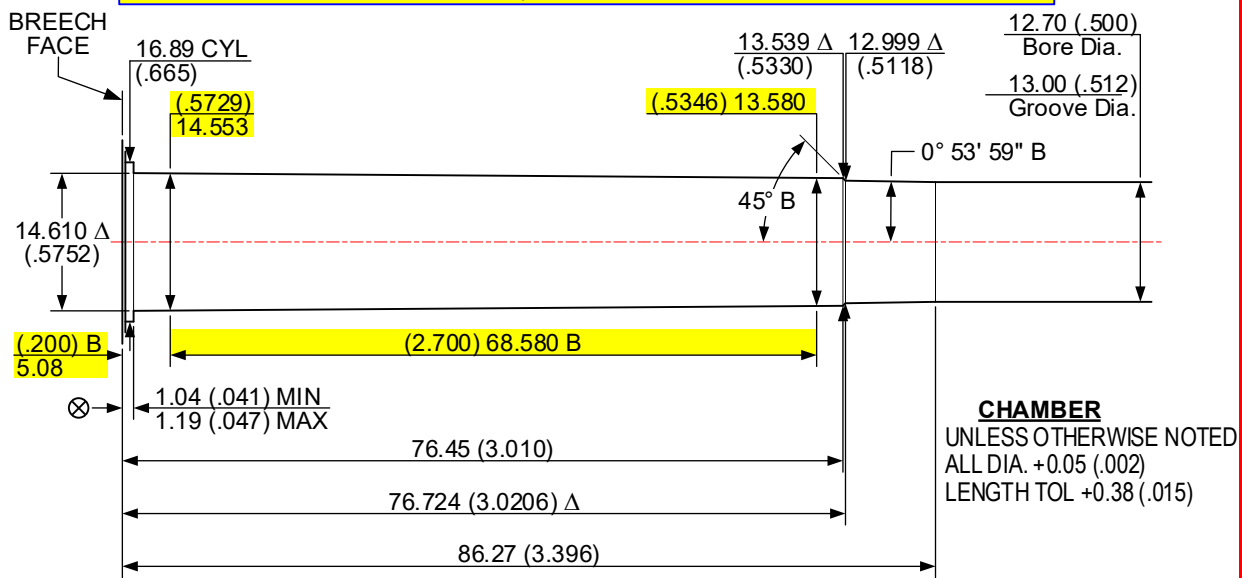

Δ 7 GROOVES TWIST: 381.0 (15.00) RH OPTIONAL
 Δ 3.61 + 0.05 (.150 + .002) WIDE MINIMUM BORE & GROOVE AREA: 130.520 mm² (.2023 in²)

NOTES:
 B = BASIC Δ = REFERENCE DIMENSION ⊗ = HEADSPACE DIMENSION
 * DIMENSIONS ARE TO INTERSECTIONS OF LINES (XX.XXXX) = INCHES
 ALL CALCULATIONS APPLY AT MAXIMUM MATERIAL CONDITION (MMC)
 (1) – BULLET PROFILE IS SHOWN FOR ILLUSTRATIVE PURPOSES ONLY

DO NOT SCALE FROM DRAWING

METRIC ORIGIN

NOTICE: This drawing is subject to change. Revisions, if applicable, are available at www.saami.org.

**DUMMY CARTRIDGE
 GUN FUNCTIONING**

BASIC CARTRIDGE

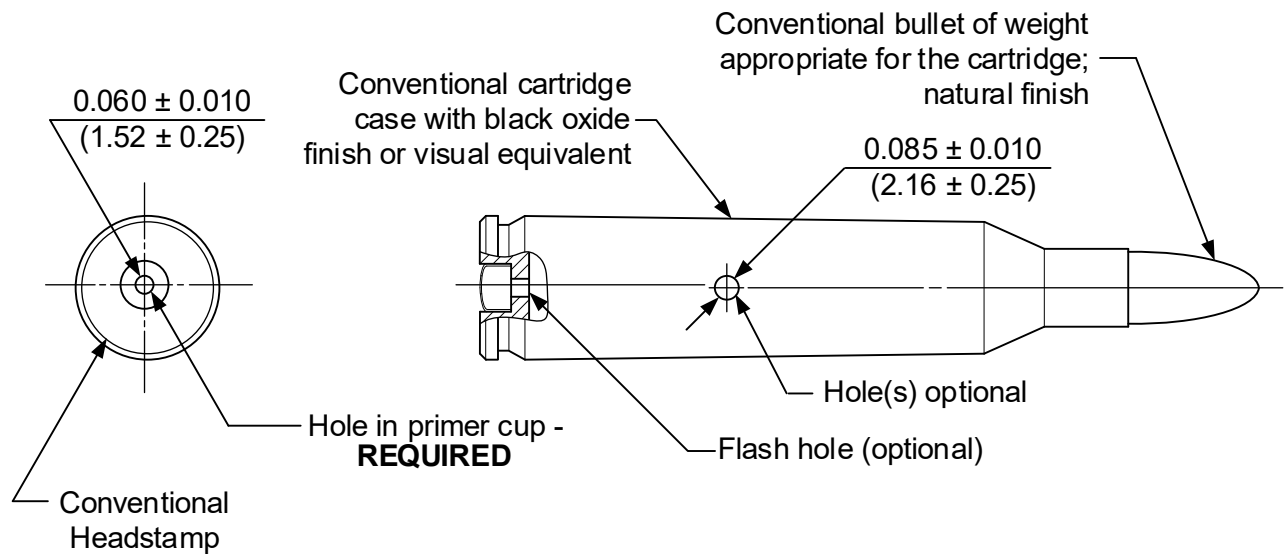

ALTERNATE CARTRIDGE

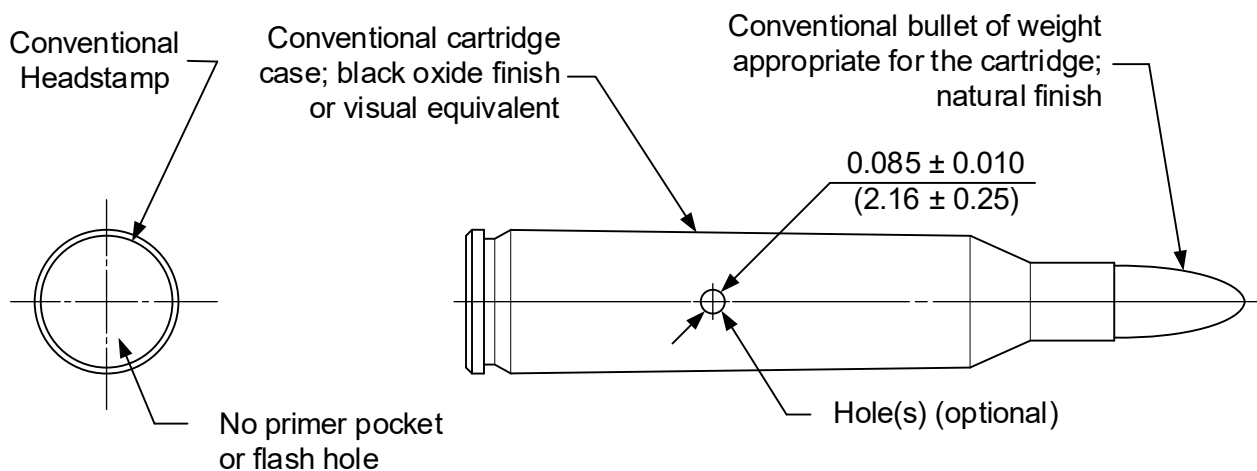

NOTES

Illustrates form only!
 Pertinent dimensions shown on appropriate cartridge drawing.
 (XX.XX) = millimeters

**DUMMY CARTRIDGE
DISPLAY**

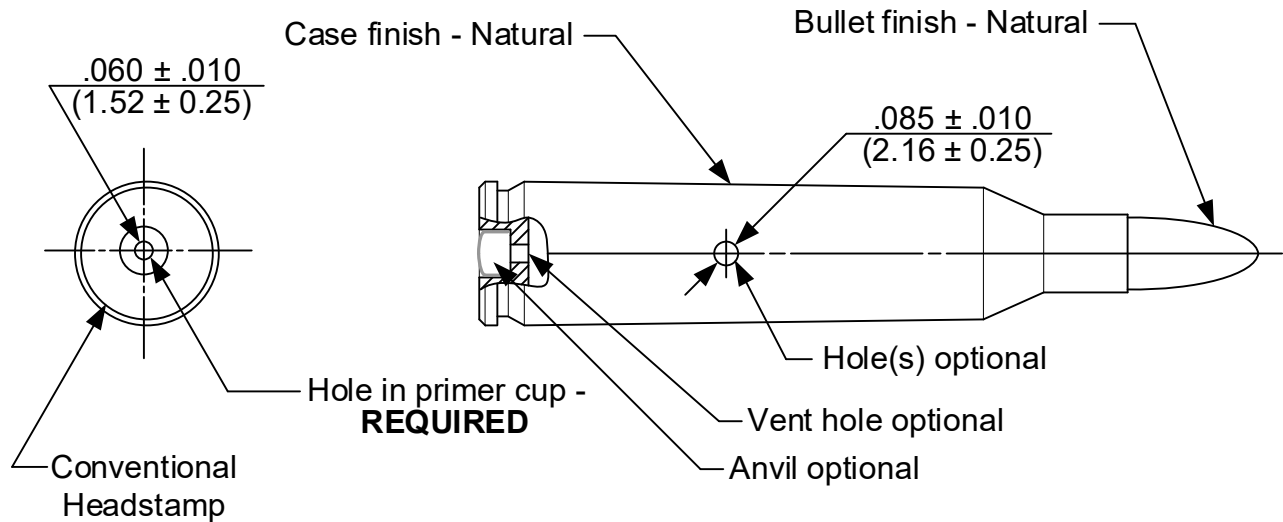

ALTERNATE CONFIGURATION

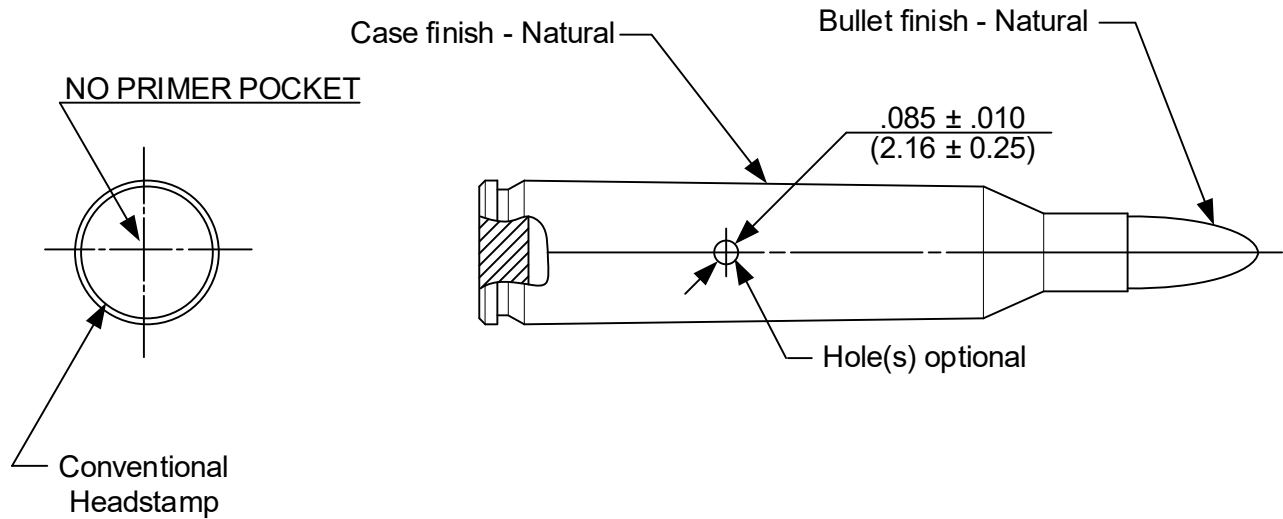

NOTE

Illustrates form only!
Pertinent dimensions shown on appropriate cartridge drawing.

(XX.XX) = millimeters

TOLERANCE – BULLET WEIGHT

1. Lead and lead-core bullets:

Less than 100 grains..... Nominal weight \pm 2.0%

Equal to or greater than 100 grains Nominal weight \pm 1.5%

2. Bullets of principally non-lead construction:

All bullet weights..... Nominal weight \pm 3.0%

PROCEDURE:
VELOCITY & PRESSURE TESTING

I. SCOPE

- A. This procedure covers the testing of ammunition for assessment of velocity and pressure using either the copper crusher method of pressure measurement or with piezoelectric pressure transducers (“transducers”).
-

II. GENERAL

- A. When testing using copper crushers, velocities and pressures are measured separately. Velocity measurements should be made using a test barrel fitted with long pistons or velocity barrels (without piston holes). Pressure measurements should be made using test barrels fitted with short pistons and gas checks. Velocities observed during pressure testing with short pistons should be recorded for information.
- B. When testing using transducers, velocities and pressures are measured simultaneously.
- C. Recommended values for velocity and pressure of all centerfire rifle cartridges are tabulated in Section I. When required, a retest of double the original quantity may be fired with statistically equivalent tolerances.
- D. Velocities and pressures should be measured using horizontally mounted test barrels in accordance with the drawings and descriptions listed in Section III.
-

III. EQUIPMENT

Refer to Section III – Equipment for detailed information on the equipment listed below.

A. COMMON

1. Universal receiver
2. Photoelectric screens
3. Electronic Counter Chronograph
4. OPTIONAL: Integrated Data Acquisition System for velocity (crusher testing) and/or velocity and pressure (conformal piezoelectric pressure transducer testing).
5. Reference ammunition

B. COPPER CRUSHER TESTING

1. Test Barrel, piston type
2. Pistons, long and short
3. Gas Checks, .206”, waxed or unfilled
4. Gas Check Wax
5. Oil
6. Gas Check Tools – Seating and knockout
7. Copper Crushers, .146” x .400” or .225” x .400” as needed
8. Measuring device for compressed copper crushers
9. Tarage Table, specific for lot of copper crushers in use

C. TRANSDUCER TESTING

NOTE: A digital data acquisition system meeting the requirements of Section III,

Equipment: Velocity & Pressure Testing is an acceptable substitute for the analog equipment referenced in this subsection.

1. Test Barrel, transducer type
2. Charge Amplifier
3. Voltmeter, Peak Capture
4. Conformal Piezoelectric Pressure Transducer
5. Low Noise Cable

IV. HANDLING OF AMMUNITION

- A. Cartridges to be tested should be placed in a vertical position with primer-end down in a recessed holding block.
- B. When the appropriate test barrel has been properly serviced and the chronograph reset, a cartridge should be lifted vertically from the block. It should be rotated slowly, end over end, in a vertical plane through 360° pausing momentarily when the powder is at the bullet end and again when the powder is at the primer end.
- C. The cartridge is then rotated slowly, a minimum amount to enter the chamber, keeping the primer end in the lowest possible position until inserted gently and carefully into the chamber.
- D. The cartridge should be seated in the chamber as far as practicable with the fingers. The bolt or breech mechanism should be closed gently in order not to disturb the position of the powder in the cartridge case. The object of this method of handling cartridges is to position the propellant powder at the primer end of the cartridge case by permitting it to fall gently against the primer while rotating the case.
- E. The rate of fire should not be rapid enough to cause excessive heating of the barrel. The time between rounds depends on the equipment, as the barrel may be cooled by a constant stream of air on the outside or by directing air through the bore after each ten rounds.
- F. Ammunition conditioning should be between 60° - 80° F (15.6° - 26.7° C).
- G. A minimum of one (1) and up to three (3) warming shots should be fired before firing each series for record. The velocity and/or pressure of these shots may be recorded but should not be included in the record of the sample.

V. PRESSURE DETERMINATION

A. COPPER CRUSHER TESTING

1. Velocities and pressure should be measured separately.
 - 1.1 Velocities should be fired in horizontally mounted test barrels of the appropriate caliber and length for the cartridges to be tested. Either pressure barrels fitted with long pistons or velocity barrels without piston and piston holes may be used.
 - 1.2 Pressure should be fired in pressure barrels fitted with short pistons for use with gas checks. Velocities should be recorded for information on rounds fired for pressure.
2. Oiling of the gas check is extremely important as a poor gas seal will cause erosion of the piston hole and piston causing erroneous readings before the barrel bore and chamber are worn out. Use SAE 30 oil (see Section III). Gas checks should be placed in a shallow container of oil. Each gas check is then blotted on absorbent material before insertion in the piston hole.
3. Insert oiled gas check with open end toward the chamber into the piston hole and seat to approximately one-half of the depth of the hole with the seating tool (see Section III).

4. Dip piston shank in oil and drain until but one drop of oil remains. Scrape the remaining drop from the bottom of the piston or blot the remaining oil on a flannel patch.
5. Insert piston in piston hole and seat on gas check manually. Do not force by striking or hammering.



CAUTION: The piston must be checked to make sure it slides freely, but not loosely, in the piston hole at all times. If the piston does not slide freely, it should be withdrawn from the piston hole and examined. Any black deposits should be removed with worn crocus cloth. If the piston is still not free in the piston hole, the hole should be cleaned with worn crocus cloth.

6. Insert cartridge to be tested in chamber of standard velocity and pressure test barrel in the manner described in paragraphs IV(B) through IV(D), above.
7. Using finger pressure, push the piston down into the piston hole until the piston/gas check is fully seated.
8. Center crusher cylinder appropriate for the cartridge under test upon the head of the piston. Slide the anvil bridge so as to center it over the crusher/piston and securely tighten the set screws on the bridge. Gently tighten the anvil against the crusher cylinder using light finger pressure.



CAUTION: Overtightening the anvil can cause precompression of the crusher cylinder and affect the subsequent pressure reading. Use care to not over-tighten the anvil.



CAUTION: The face of the piston head, face of set screw and faces of crusher must be free from oil.

9. The breech mechanism should be closed gently.
10. After firing the cartridge, the compressed crusher cylinder should be removed and measured for remaining length. Pressure is determined from this length by the use of the Tarage Table, furnished with the cylinders, for the piston diameter used.
11. The piston is removed, and the gas check and the disk blanked from the cartridge case by internal gas pressure is removed after each shot by driving the gas check downward with the knockout tool (see Section III) into the fired cartridge case.
12. The fired cartridge case containing the gas check and disk blanked from the cartridge case is removed from the chamber.



CAUTION: The chamber and bore should be checked to make certain that the barrel is unobstructed before proceeding further.

13. For subsequent shots in a series, the procedure shown in paragraphs V(A)(1) through V(A)(10) are repeated.

B. PIEZO-ELECTRIC TRANSDUCER TESTING

1. EQUIPMENT PREPARATION

- 1.1 Refer to the SAAMI-recommended piezo pressure transducer installation in a pressure barrel illustrated in Section III.
- 1.2 The charge amplifier and peak capture voltmeter should have a certified calibration traceable to the National Institute of Standards and Technology on a schedule in accordance with the manufacturer's recommendations or the user's internal practices for calibration frequency.

2. INITIAL SET-UP

- 2.1 Turn on the electronic equipment and allow to warm up and stabilize as recommended by the manufacturer.
- 2.2 Inspect the transducer mounting cavity in the pressure barrel to assure that the seal seat is free of dirt and any other foreign matter.
- 2.3 Mount transducer with steel spacer rings into the test barrel as described in the transducer manufacturer's instructions Manual.
- 2.4 Loosen, but do not remove, the slotted clamp.
- 2.5 Thread the transducer into the mounting port. Adjust the slotted clamp to allow guide pin to enter guide hole. Continue to turn transducer nut into the mounting port. When transducer bottoms, tighten the slotted clamp and torque the transducer as recommended by the manufacturer.
- 2.6 It is essential that the sensing surface of the transducer be flush with the chamber inside diameter. Care must be exercised to obtain correct depth as well as exact rotational alignment. Depth adjustment is accomplished by the use of various thickness spacers. In order to set the depth exactly it may be necessary to hone the spacers to the desired thickness.

IMPORTANT: Always switch the OPERATE-GND switch to the "GND" (ground) position before making connections to the charge amplifier and allow switch to remain in this position during such connections. This protects the FET input stage against possible gate damage from excessive accumulated static charge. The cable should be shorted to dissipate any accumulated static charge prior to connection by temporarily connecting the cable connector's center pin to the outer shell with a clean conductive tool or bare wire.

- 2.7 Connect equipment as shown on pages 187 and 188.
NOTE: Configurations 1 and 2 are interchangeable.

- 2.8 Set the charge amplifier controls for short time constant, transducer sensitivity to the slope (m) obtained from the transducer least square line equation and set the GROUND/OPERATE switch to the OPERATE position.
- 2.9 Select digital peak meter, positive input, peak mode, and 10-volt range.
- 2.10 Take note of the transducer offset value (P) obtained from the least square line equation. This value will be used later in making final peak pressure determination.
 - (a) The offset value may also be dialed into an instrumentation system capable of providing direct peak pressures without data manipulation.
3. *PROCEDURE*
 - 3.1 Reset all pressure instrumentation and assure that the peak meter digital display reads all zeros. Test rounds may now be fired.
 - 3.2 For each round fired, the pressure reading on the digital display should be recorded and pressure instrumentation reset.
4. *PEAK PRESSURE DETERMINATION*
 - 4.1 To determine peak pressures, add as required, the pressure offset value to the pressure readings obtained in the firing test. Adding the offset value is not required if it is dialed in on the peak meter.

VI. VELOCITY DETERMINATION

- A. Handling of the ammunition should be in accordance with the instructions in paragraph IV.
- B. Photoelectric screens should be arranged in accordance with the arrangement shown on page 234, “*Equipment: Schematic Layout of Velocity Screens*”.
- C. A table of time of flight vs. velocity should be used to determine instrumental velocity at 15 feet (4.57 m) from the gun muzzle (not required when using direct reading equipment).
- D. It is recommended that a blast shield be positioned between the muzzle of the Universal Receiver test barrel and the first velocity screen to minimize the possibility of premature triggering of the velocity screens. With velocities below the speed of sound, the muzzle blast and/or muzzle flash will reach the screen before the bullet and may cause premature triggering of the screen. For example, premature triggering of the first screen will result in abnormally low velocity readings. Premature triggering of both screens will result in velocity readings which correspond to the speed of sound (approximately 1,120 fps at sea level and normal atmospheric conditions).
 - (i) The blast shield should be made of rigid, opaque material of sufficient strength to withstand the shock wave but not be resistant to the passage of the projectile.

VII. RECORDING OF TEST RESULTS

- A. The following data should be recorded for each series of shots fired for velocity and pressure.
 1. Ammunition Data
 - 1.1 Date of test
 - 1.2 Nominal cartridge identification
 - 1.3 Cartridge caliber
 - 1.4 Bullet weight and type
 - 1.5 Powder charge, type, and lot
 - 1.6 Priming

- 1.7 Type of lubricant (if any)
- 1.8 Code or date of loading
2. Average velocity, uncorrected.
3. Average pressure, uncorrected.
4. Maximum and minimum individual velocity.
5. Maximum and minimum individual pressure.
6. Extreme variation (range) of velocity.
7. Extreme variation (range) of pressure.
8. Other statistical indication of variation (optional).
9. Correction to results from firing Reference Ammunition (optional).
10. Corrected average velocity (optional).
11. Corrected average pressure (optional).
12. Recommended values
 - 12.1 Average velocity
 - 12.2 Average pressure
 - 12.3 Velocity and pressure variation
13. Test firearm and range data
 - 13.1 Barrel length and serial number
 - 13.2 Barrel history
 - 13.3 Transducer serial number / copper crusher lot number
 - 13.4 Type of chronograph and screens
14. Test personnel.

VIII. USE OF REFERENCE AMMUNITION

A. Purpose

1. Reference ammunition, assessed by firings at the ranges of member companies, is available for calibrating ranges, firearms and other equipment for velocity and pressure only.

B. Supply

1. On request, the SAAMI Technical Office¹ will supply information on the manufacturer of specific Reference Ammunition. The method of identifying Reference Ammunition is shown in Section II.
2. Requests for Reference Ammunition should be addressed to the manufacturer of the specific cartridge.

C. Assessment

1. Details of the assessment tests are shown in Section II.

D. Clearing House

1. Results of assessment tests of Reference Ammunition are tabulated, analyzed and distributed by the SAAMI Technical Office.

E. Corrections

¹ Refer to Section III, page 233 for contact information for the SAAMI Technical Office.

1. For method of applying corrections to tests of service loads see Section II.

F. Calibration

1. For method of calibrating ranges and equipment, see Section II.

IX. TEST BARREL CLEANING

A. Test barrels should be cleaned regularly after each 10-round test with bore cleaner and solvent (such as Hoppe's #9 or equivalent) and a brass or bronze wire brush. If cleaning is not done with this frequency, fouling buildup may cause erroneous readings. Three to five complete cycles with the brush are required. Pass the brush completely through the bore on each stroke. If testing is completed for a period of time, leave a light coating of bore cleaner in the bore. Before re-use, two or three tight cloth patches should be used to wipe the solvent from the bore. After standing for several days, the solvent evaporates to a wax coating and wetting the bore with solvent with the first cloth patch helps remove the residue.

VELOCITY & PRESSURE BARRELS: QUALIFICATION

All barrels are not necessarily suitable for use in determining pressure or velocity levels, even though they may conform to the dimensions given on the appropriate Standard Velocity and Pressure Barrel drawing in this Standard. New barrels may require a number of rounds to be fired to remove sharp corners or burrs resulting from the manufacturing process. Barrels in service do not have an unlimited life and may become unserviceable from wear and erosion. There is no predictable number of rounds to which a barrel should be exposed before use for pressure and velocity determinations, nor is there a predictable round life for such equipment.

The following procedure is suggested for determining the suitability of any barrel for pressure and velocity test use:

Fire ten rounds of SAAMI Reference Ammunition following the procedures as shown in this Standard. The average velocity and pressure results of the test should be within the Inclusion Limits as given on the latest assessment of the lot fired.

In the case of a new barrel, the firing of more breaking-in shots may be indicated after which the Reference Ammunition test should be repeated.

In the case of barrels which have been in service, refurbishing of the piston and piston hole, removal of fouling, or other corrective procedures may be implemented followed by a retest.

VELOCITY & PRESSURE BARRELS: MOUNTING IN RECEIVERS

It is essential that close headspace be maintained in velocity-pressure testing equipment if reliable test results are to be achieved.

In mounting test barrels to Universal Receivers or test actions, a headspace not exceeding .003” (.07 mm) over minimum should be maintained. This may be measured by headspace gauges, shim stock or feeler gauges, or a combination thereof whichever is most appropriate for the type of equipment being used.

Headspace adjustments with the Universal Receiver may be accomplished by several methods:

1. Formed shim stock behind the firing-pin plate.
2. Formed shim stock on the rear bearing shoulder of the Barrel Collar.
3. Adjustment of the Breech Block Locking Screws.

PROCEDURE:
USE OF PISTON HOLE GAUGES

Pressure barrel piston hole size should be checked periodically with piston hole gauges to determine whether or not erosion is present. Piston hole erosion can cause high or erratic pressure readings and low velocity readings.

Three piston hole gauges for each piston hole size (.146" diameter, .206" diameter) constitute a set: 1) plug gauge, 2) longitudinal gauge, and 3) transverse gauge. Each gauge is double-sided, "go" and "no go". The gauges are used as described below:

1. Attempt to insert the appropriate "no go" plug gauge into the top of the piston hole.
2. Insert the appropriate "no go" longitudinal gauge through the chamber, align it with the bottom of the piston hole, and attempt to insert the gauge upward into the hole.
3. Attempt to insert the appropriate "no go" transverse gauge into the bottom of the piston hole in the same manner as described above for the longitudinal gauge.
4. If the piston hole accepts any of the "no go" gauges, the hole diameter is larger than the maximum acceptable.

The probable cause of extreme piston hole erosion is poor gas sealing (improper use of gas checks and/or insufficient oiling).

In some cases, minor erosion does not seem to affect pressure and velocity readings. An analysis of test results will indicate whether or not repair is necessary.

PROCEDURE: PIEZOELECTRIC TRANSDUCER CALIBRATION

I. SCOPE

- A. This procedure covers the calibration of piezoelectric pressure transducers (“transducers”) for use in the measurement of ballistic pressures. This procedure replaces prior instructions contained within a larger subsection as it relates to calibration activities.

II. TEST EQUIPMENT

Refer to Section III for detailed information on the equipment listed below.

NOTE: A digital data acquisition system meeting the requirements detailed in Section III, *Equipment: Velocity & Pressure Testing*, is considered an acceptable substitute to the analog equipment and methods of this subsection.

1. Digital Voltmeter
2. Charge Amplifier
3. Transducer Calibrator
4. Insulation Tester
5. Transducer
6. Low Noise Cable
7. Calibration Adapter

III. EQUIPMENT PREPARATION

- A. All instruments should be operational and calibrated per manufacturer specification.
- B. The transducer calibrator and instruments used to calibrate the charge amplifier and digital voltmeter should have a certified calibration traceable to the National Institute of Standards and Technology on a schedule in accordance with the manufacturer’s recommendations or the user’s internal practices for calibration frequency.
- C. Transducers should be properly maintained per manufacturer recommendations or stored in a desiccator when not in use.



CAUTION: When not in use, the cable, transducers, and instrument connectors should be stored with plastic caps to prevent contamination.

- D. Measure the internal resistance of the transducer and low noise cable. If the resistance is less than 10^{12} ohms (Ω), follow the steps detailed in paragraph IV, *Transducer Initialization*. If the resistance is in the 10^{12} -to- 10^{14} Ω range, proceed to paragraph V, *Transducer Calibration*.

IV. TRANSDUCER INITIALIZATION

- A. Clean transducer and low noise cable connectors using an acceptable solvent per the manufacturer’s recommendations.
- B. Bake-out transducer and low noise cable in a temperature-controlled oven for 30 – 60 minutes at 250° F (121° C).

- C. Allow oven to return to ambient temperature.
NOTE: Do not use the transducer until it has returned to ambient temperature. Failure to allow the transducer to cool to ambient before use could result in signal drift.
- D. After removing the transducer and cable from the oven, check the internal resistance of the transducer. The resistance should be in the 10^{12} - 10^{14} Ω range.
- E. Place protective caps on transducer and cable connectors to prevent contamination.

V. TRANSDUCER CALIBRATION

A. INITIAL SET-UP

1. Turn on the electronic equipment and allow it to warm up and stabilize as recommended by the manufacturer.
2. Inspect the transducer mounting cavity to assure that the seal seat is free of dirt and any other foreign matter.
3. Mount transducer with steel spacer rings into calibration fixture as described in the manufacturer's operating instructions manual.
4. Loosen, but do not remove, the slotted clamp.
5. Thread the transducer into the mounting port. Adjust the slotted clamp to allow guide pin to enter guide hole. Continue to turn transducer nut into the mounting port. When transducer bottoms, tighten the slotted clamp and torque the transducer as recommended by the manufacturer.
6. It is essential that the sensing surface of the transducer be flush with the chamber inside diameter. Care must be exercised to obtain correct depth as well as exact rotational alignment. Depth adjustment is accomplished by the use of various thickness spacers. In order to set the depth exactly it may be necessary to hone the spacers to the desired thickness.
7. Mount calibration adapter with transducer on the calibrator.
8. Insert the cartridge case with an inert or fired primer into calibration adapter and complete fixture assembly as per the calibration adapter manufacturer's instruction manual. If the sample cartridge is a loaded round, it may be disassembled, the powder removed, and the primer in the empty case then fired. An optional procedure is to de-prime the case and use the O-ring/plug seal shown in Section III on page 240. Cycle this case to the appropriate maximum pressure in order to "seat" the transducer.
NOTE: When using cases with fired primers it is recommended the cases be thoroughly cleaned prior to use for calibration to prevent contamination of the hydraulic oil in the transducer calibrator.
9. Set the charge amplifier sensitivity to .999, set the time constant switch to LONG, and place the amplifier in GROUND mode.
10. Connect transducer and instrumentation as indicated on page 184.
11. Set DVM to 10-volt range.

B. CALIBRATION

NOTE: Transducers need to undergo a new case calibration when changing brands/sources of ammunition (cartridge cases) or if there have been changes in cartridge case manufacturing processes and/or material.

1. Adjust the pressure readout indicator of the transducer calibrator to 0 psi with no pressure on hydraulic lines.

2. Insert a new cartridge case that has been prepared in accordance with the calibrator manufacturer's recommendations and using a new O-ring.
3. Reset charge amplifier and digital voltmeter (DVM) to obtain zero volts output.
4. Apply pressure in increments as indicated in Section II, pages 179ff. Calibration pressure range should cover the pressure ranges shown in Section II. DO NOT exceed the maximum pressure established by the manufacturer for the fixture.
5. Record DVM reading after the pressure readout indicator is exactly at desired pressure level. Do not release the pressure until the highest pressure level, for the cartridge under test, has been reached. Read the pressure at each increment. Do not overshoot the pressure points!



CAUTION: Always ***INCREASE*** pressure to desired level, never decrease pressure to desired level.

6. After reaching the highest calibration pressure level, release the pressure slowly until no pressure remains in the hydraulic lines.
7. Replace the cartridge case in calibration adapter with a new case.
8. Repeat steps 2 through 7 until a minimum of five (5) valid data points are obtained.

C. DATA REDUCTION

1. Calculate the average value for the output voltages recorded at each pressure increment. Multiply these average values by the charge amplifier sensitivity (pC/V) to obtain the transducer charge output (Q) at these pressure increments (P).
2. Obtain a least square line equation using the transducer charge output (Q) as the dependent variable and pressure (P) as the independent variable. $Q = mP \pm q$.
3. A manual method of calculating the least square line equation is given in tabular form on pages 185ff. It is recommended that when using this technique, all numbers be carried to the third decimal place.
4. Obtain the pressure (P) offset value when Q in the line equation is zero. Refer to page 186.

VI. CALIBRATION CHECK

- A. When the calibration calculations are complete, the sensitivity from those calculations with the case being tested should be set on the charge amplifier. The digital voltmeter is set at zero. A new sample cartridge case is put in the calibration fixture and the hydraulic pressure increased to the highest pressure reached in the calibration. The digital voltmeter reading plus the offset should equal the hydraulic gauge reading. Check calibration again by inserting a second cartridge case. As a guideline, these values should agree within $\pm 1.5\%$ of the gauge reading. If the transducer does not meet this guideline, then recheck the calculations and/or recalibrate.

VII. TRANSDUCER RECORDS

- A. Date of calibration
- B. The number of rounds to which the transducer has been exposed during test firing.
- C. Calibration pressure (P), charge amplifier voltage output (V), and transducer charge output (Q).

- D. Charge amplifier sensitivity.
- E. Least square line equation.
- F. Pressure offset, and transducer sensitivity (slope = m).
- G. Transducer identification.
- H. Date of next calibration.

**TRANSDUCER CALIBRATION:
 INCREMENTS AND RANGES**

The following increments and ranges are to be used for the calibration of transducers:

Cartridge	MAP (psi/100)	Pressure Increments (psi)	Pressure Range (psi)
6mm Advanced Rifle Cartridge	520	5,000	35,000 – 60,000
6mm Creedmoor	620	5,000	35,000 – 60,000
6mm GT	620	5,000	35,000 – 60,000
6mm Remington	650	5,000	35,000 – 60,000
6.5 Creedmoor	620	5,000	35,000 – 60,000
6.5 Grendel	520	5,000	35,000 – 60,000
6.5 Precision Rifle Cartridge	650	5,000	35,000 – 60,000
6.5 Weatherby Rebated Precision Magnum	650	5,000	35,000 – 60,000
6.5-284 Norma	580	5,000	35,000 – 60,000
6.5-300 Weatherby Magnum	650	5,000	35,000 – 60,000
6.5 x 55 Swedish	510	5,000	35,000 – 60,000
6.8 True Velocity Composite ¹	700 ¹	5,000	50,000 – 75,000
6.8 Western	650	5,000	35,000 – 60,000
6.8mm Remington SPC	550	5,000	35,000 – 60,000
7mm Mauser (7 x 57)	510	5,000	35,000 – 60,000
7mm Precision Rifle Cartridge	650	5,000	35,000 – 60,000
7mm Remington Magnum	610	5,000	35,000 – 60,000
7mm Remington Short Action Ultra Magnum	650	5,000	35,000 – 60,000
7mm Remington Ultra Magnum	650	5,000	35,000 – 60,000
7mm Weatherby Magnum	650	5,000	35,000 – 60,000
7mm Winchester Short Magnum	650	5,000	35,000 – 60,000
7mm-08 Remington	610	5,000	35,000 – 60,000
7 x 64 Brenneke	550 ^(T)	5,000	35,000 – 60,000
7.62 x 39	450	5,000	25,000 – 50,000
8mm Mauser (8 x 57)	350	5,000	20,000 – 45,000
9.3 x 62	575	5,000	35,000 – 60,000
17 Hornet	500	5,000	35,000 – 60,000
17 Remington	630	5,000	35,000 – 60,000
17 Remington Fireball	550	5,000	35,000 – 60,000

¹ NOTE: Refer to pages 201 and 202 for equipment for Maximum Allowable Pressures exceeding 65,000 psi.

**TRANSDUCER CALIBRATION:
 INCREMENTS AND RANGES
 (Continued)**

Cartridge	MAP (psi/100)	Pressure Increments (psi)	Pressure Range (psi)
204 Ruger	575	5,000	35,000 – 60,000
218 Bee	N/E ⁽¹⁾	N/E	N/E
22 Advanced Rifle Cartridge	520	5,000	35,000 – 60,000
22 Creedmoor	620	5,000	35,000 – 60,000
22 Hornet	490	5,000	35,000 – 60,000
22 Nosler	550	5,000	35,000 – 60,000
22-250 Remington	650	5,000	35,000 – 60,000
220 Swift	620	5,000	35,000 – 60,000
221 Remington Fireball	N/E	N/E	N/E
222 Remington	500	5,000	35,000 – 60,000
222 Remington Magnum	550	5,000	35,000 – 60,000
223 Remington	550	5,000	35,000 – 60,000
223 Winchester Super Short Magnum	650	5,000	35,000 – 60,000
224 Valkyrie	550	5,000	35,000 – 60,000
243 Winchester	600	5,000	35,000 – 60,000
243 Winchester Super Short Magnum	650	5,000	35,000 – 60,000
25 Winchester Super Short Magnum	650	5,000	35,000 – 60,000
25-06 Remington	630	5,000	35,000 – 60,000
25-20 Winchester	N/E	N/E	N/E
25-35 Winchester	N/E	N/E	N/E
250 Savage	N/E	N/E	N/E
257 Roberts	540	5,000	35,000 – 60,000
257 Roberts +P	580	5,000	35,000 – 60,000
257 Weatherby Magnum	625	5,000	35,000 – 60,000
26 Nosler	650	5,000	35,000 – 60,000
260 Remington	600	5,000	35,000 – 60,000
264 Winchester Magnum	640	5,000	35,000 – 60,000

¹ N/E = Not Established.

**TRANSDUCER CALIBRATION:
 INCREMENTS AND RANGES
 (Continued)**

Cartridge	MAP (psi/100)	Pressure Increments (psi)	Pressure Range (psi)
27 Nosler	650	5,000	35,000 – 60,000
270 Weatherby Magnum	625	5,000	35,000 – 60,000
270 Winchester	650	5,000	35,000 – 60,000
270 Winchester Short Magnum	650	5,000	35,000 – 60,000
277 SIG Fury ¹	800 ¹	5,000	55,000 – 80,000
28 Nosler	650	5,000	35,000 – 60,000
280 Ackley Improved	650	5,000	35,000 – 60,000
280 Remington	600	5,000	35,000 – 60,000
284 Winchester	560	5,000	35,000 – 60,000
30 Carbine	400	5,000	20,000 – 45,000
30 Nosler	650	5,000	35,000 – 60,000
30 Remington AR	550	5,000	35,000 – 60,000
30 Thompson Center	620	5,000	35,000 – 60,000
30-06 Springfield	600	5,000	35,000 – 60,000
30-30 Winchester	420	5,000	25,000 – 50,000
30-40 Krag	N/E ⁽²⁾	N/E	N/E
300 AAC BLACKOUT	550	5,000	35,000 – 60,000
300 HAM'R	575	5,000	35,000 – 60,000
300 Holland & Holland Magnum	580	5,000	35,000 – 60,000
300 Norma Magnum	610	5,000	35,000 – 60,000
300 Precision Rifle Cartridge	650	5,000	35,000 – 60,000
300 Remington Short Action Ultra Magnum	650	5,000	35,000 – 60,000
300 Remington Ultra Magnum	650	5,000	35,000 – 60,000
300 Ruger Compact Magnum	650	5,000	35,000 – 60,000
300 Savage	470	5,000	30,000 – 55,000
300 Weatherby Magnum	650	5,000	35,000 – 60,000
300 Winchester Magnum	640	5,000	35,000 – 60,000
300 Winchester Short Magnum	650	5,000	35,000 – 60,000
303 British	490	5,000	35,000 – 60,000

¹ NOTE: Refer to pages 201 and 202 for equipment for Maximum Allowable Pressures exceeding 65,000 psi.

² N/E = Not Established.

**TRANSDUCER CALIBRATION:
 INCREMENTS AND RANGES
 (Continued)**

Cartridge	MAP (psi/100)	Pressure Increments (psi)	Pressure Range (psi)
307 Winchester	N/E	N/E	N/E
308 Marlin Express	475	5,000	30,000 – 55,000
308 Winchester	620	5,000	35,000 – 60,000
32 Winchester Special	420	5,000	25,000 – 50,000
32-20 Winchester	N/E	N/E	N/E
325 Winchester Short Magnum	650	5,000	35,000 – 60,000
33 Nosler	650	5,000	35,000 – 60,000
338 Federal	620	5,000	35,000 – 60,000
338 Lapua Magnum	650	5,000	35,000 – 60,000
338 Marlin Express	460	5,000	30,000 – 55,000
338 Norma Magnum	625	5,000	35,000 – 60,000
338 Remington Ultra Magnum	650	5,000	35,000 – 60,000
338 Ruger Compact Magnum	650	5,000	35,000 – 60,000
338 Weatherby Precision Rebated Magnum	650	5,000	35,000 – 60,000
338 Winchester Magnum	640	5,000	35,000 – 60,000
340 Weatherby Magnum	625	5,000	35,000 – 60,000
348 Winchester	450	5,000	25,000 – 50,000
35 Remington	335	5,000	20,000 – 45,000
35 Whelen	620	5,000	35,000 – 60,000
350 Legend	550	5,000	35,000 – 60,000
356 Winchester	N/E	N/E	N/E
358 Winchester	N/E	N/E	N/E
360 Buckhammer	500	5,000	35,000 – 60,000
370 Sako Magnum	600	5,000	35,000 – 60,000
375 Holland & Holland Magnum	620	5,000	35,000 – 60,000
375 Remington Ultra Magnum	650	5,000	35,000 – 60,000
375 Ruger	620	5,000	35,000 – 60,000
375 Winchester	N/E	N/E	N/E
376 Steyr	620	5,000	35,000 – 60,000

**TRANSDUCER CALIBRATION:
 INCREMENTS AND RANGES
 (Continued)**

Cartridge	MAP (psi/100)	Pressure Increments (psi)	Pressure Range (psi)
38-40 Winchester	N/E	N/E	N/E
38-55 Winchester	N/E	N/E	N/E
400 Legend	450	5,000	25,000 – 50,000
405 Winchester	460	5,000	30,000 – 55,000
416 Remington Magnum	650	5,000	35,000 – 60,000
416 Rigby	520	5,000	35,000 – 60,000
416 Ruger	620	5,000	35,000 – 60,000
416 Weatherby Magnum	N/E	N/E	N/E
44 Remington Magnum	360	5,000	20,000 – 45,000
44-40 Winchester	110	2,000	10,000 – 18,000
444 Marlin	420	5,000	25,000 – 50,000
45-70 Government ¹	280	5,000	15,000 – 40,000
450 Bushmaster	385	5,000	20,000 – 45,000
450 Marlin	435	5,000	25,000 – 50,000
458 Lott	625	5,000	35,000 – 60,000
458 Winchester Magnum	600	5,000	35,000 – 60,000
470 Nitro Express	410	5,000	25,000 – 50,000
500 Nitro Express 3”	385	5,000	20,000 – 45,000

¹ The calibration band for the 45-70 Gov’t does not conform to the standardized guidance due to testing done on ammunition loaded to 18,000 psi.

**TRANSDUCER CALIBRATION:
EQUIPMENT INTERCONNECTION**

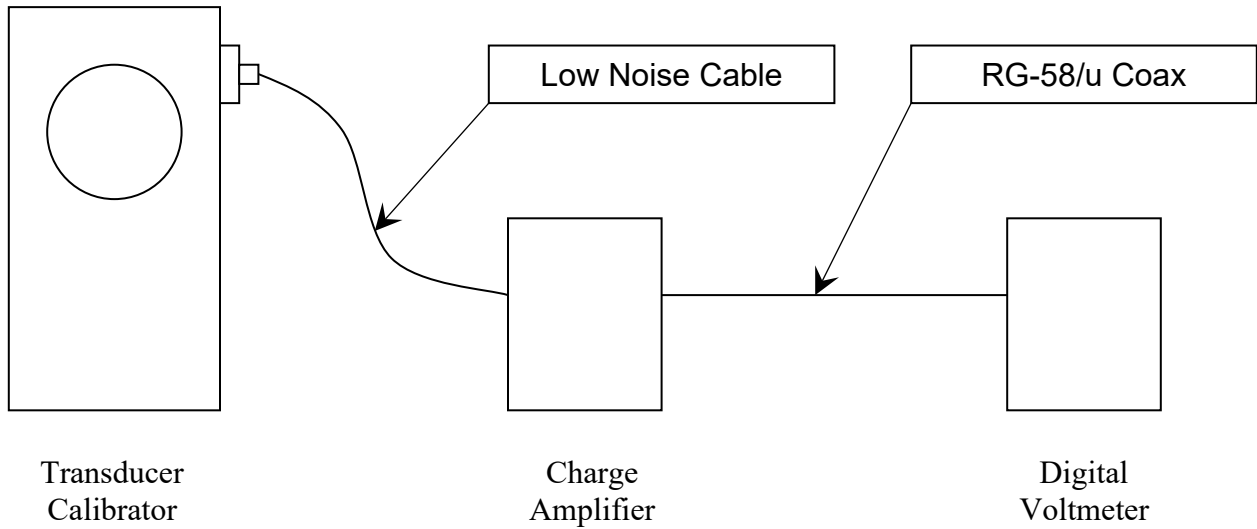

Figure 2

**TRANSDUCER CALIBRATION:
 LEAST SQUARE LINE COMPUTATION**

$$Q = mP + q$$

$$m = \frac{\sum(PQ) - \frac{\sum P \sum Q}{n}}{\sum P^2 - \frac{(\sum P)^2}{n}} \quad q = \frac{\sum P \sum(PQ) - \sum(P^2) \sum Q}{(\sum P)^2 - n \sum P^2}$$

Where:

n = Number of data points.

Q = Charge, in picocoulombs, pC.

m = Slope ($\Delta Q/\Delta P$); transducer sensitivity in pC/psi.

P = Pressure, in pounds per square inch, psi.

q = Charge intercept, in picocoulombs, pC.

V = Average output voltage at the indicated pressure, in volts, v.

S = Charge amplifier sensitivity.

$$Offset = \frac{q}{m}$$

	P	S	V	Q (SV)	(PQ)	P ²
TOTAL	$\Sigma P =$			$\Sigma Q =$	$\Sigma(PQ) =$	$\Sigma(P^2) =$

Figure 3

OUTPUT vs. PRESSURE

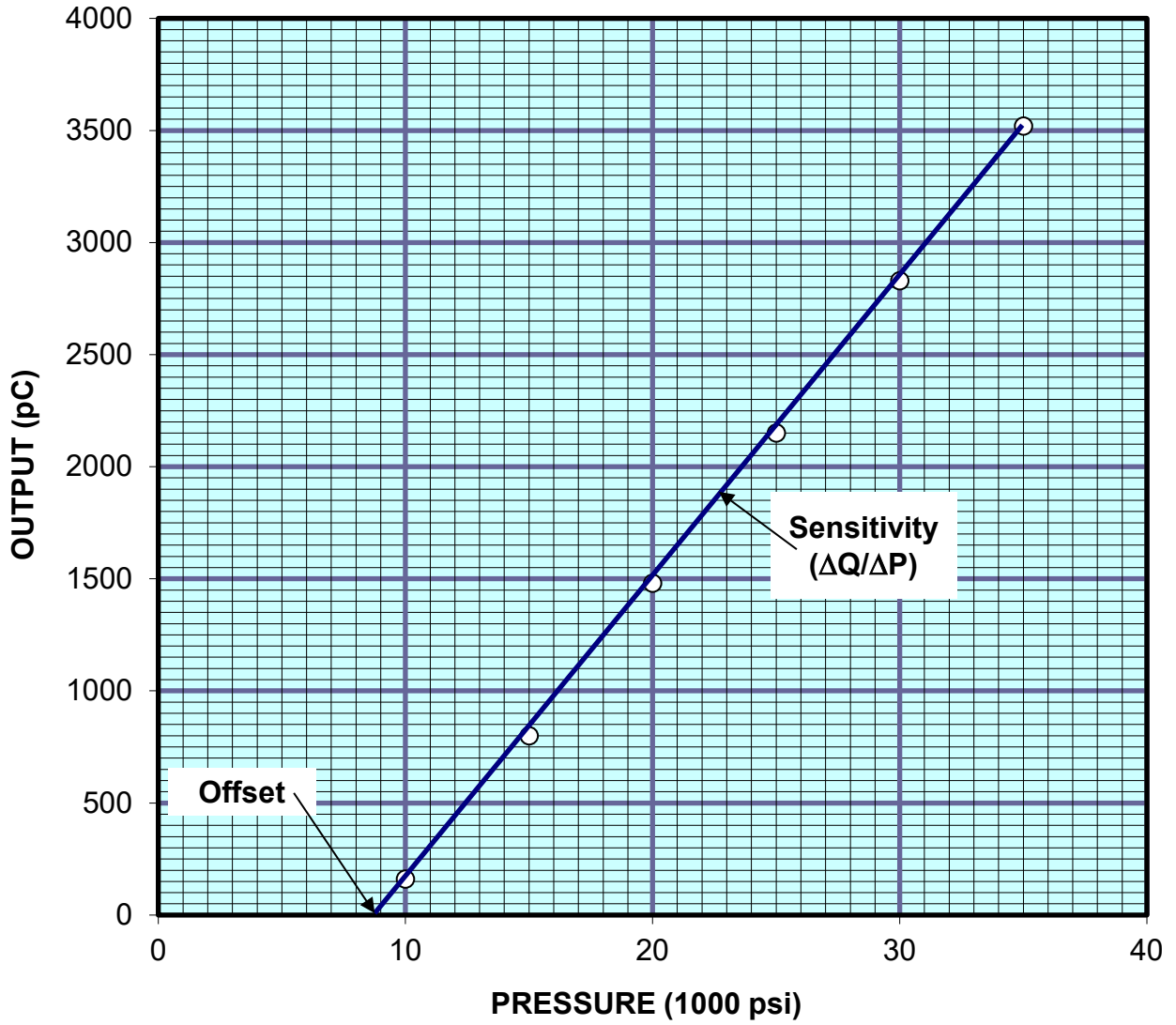

Figure 4

**FIRING TEST:
EQUIPMENT INTERCONNECTION**

Configuration 1

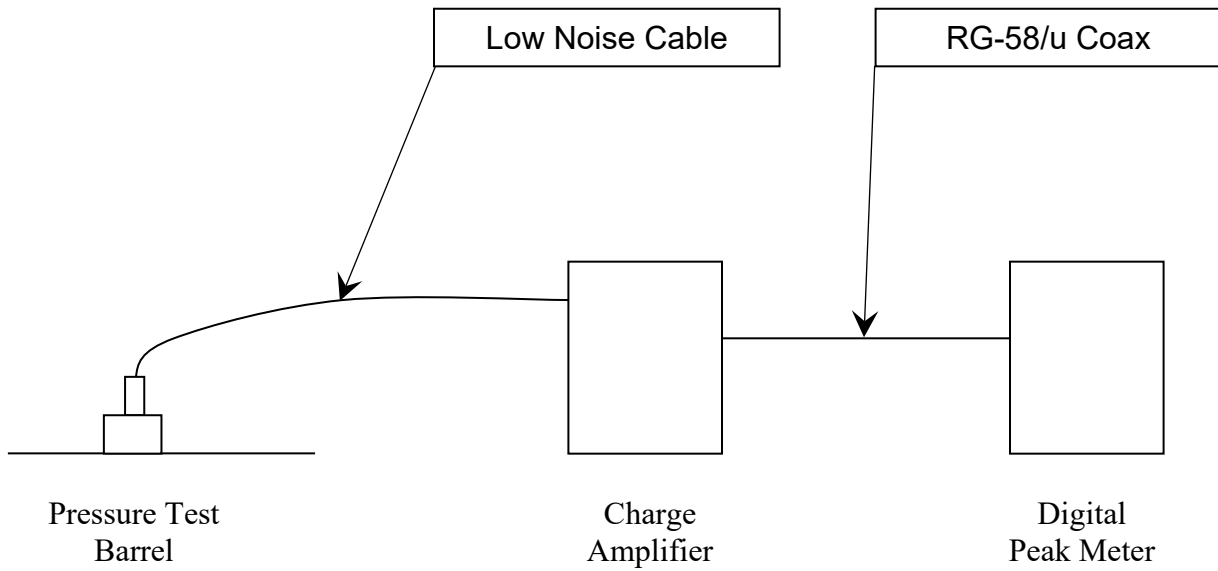

Figure 5

**FIRING TEST:
EQUIPMENT INTERCONNECTION (cont'd)**

Configuration 2

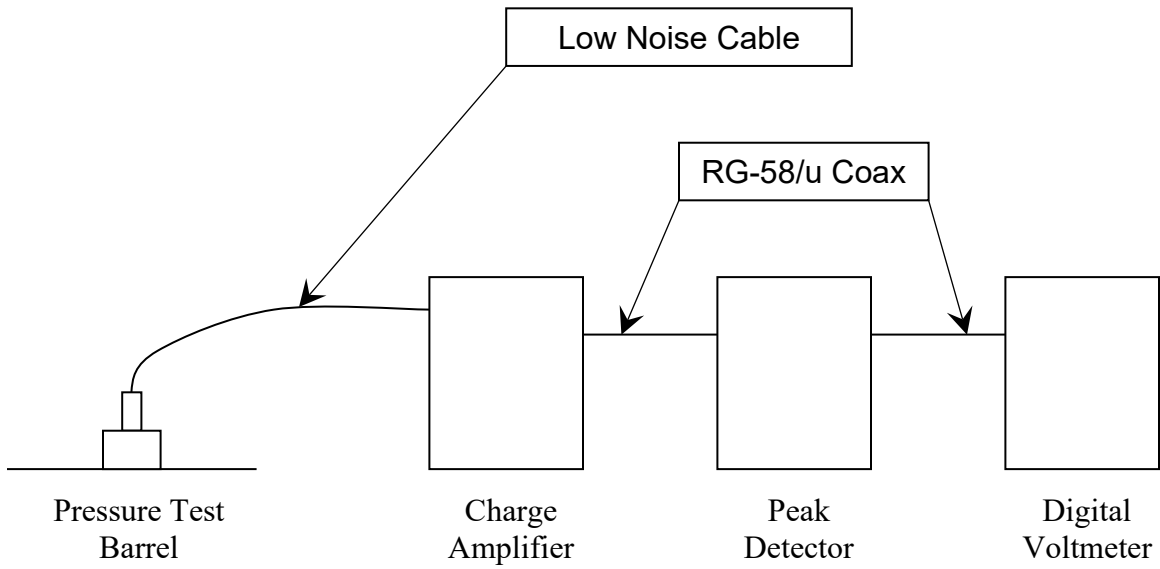

Figure 6

REFERENCE AMMUNITION: USE

A. PURPOSE

Reference Ammunition is for the purpose of relating pressure and velocity test results at all ranges.

B. PROCUREMENT

Reference Ammunition is procured as noted in Section III pages 231 and 232.

C. USE

The use and usefulness of Reference Ammunition in connection with the testing of ammunition for velocity and pressure is predicated upon two basic assumptions as follows:

1. Associated with a given batch of Reference Ammunition at a given time is an assessed average velocity, an assessed average pressure, as well as upper and lower limits for each, which the averages of any ten round test may be expected to fall within when:
 - a. The reference ammunition manufacturer has applied appropriate safeguards to assure homogeneity of the lot.
 - b. The ammunition is tested only after being conditioned under controlled temperature and humidity.
 - c. The ammunition is tested in equipment compliant with Section III recommendations.
 - d. The ammunition is handled in strict accordance with Section II recommendations.
 - e. All auxiliary measuring equipment has been set up in accordance with Section II recommendations and is in proper working condition.
2. Although there will be changes over time in the velocity and pressure assessments, the changes occur sufficiently slowly to be detected by periodic reassessments before they have achieved a magnitude sufficient to impair the usefulness of the reference rounds. In other words, the velocity and pressure assessments are reasonably stable with time.

The average velocity and pressure that may be developed by a sample of Reference Ammunition in any given standard test barrel under given test conditions may be different from the results obtained under the test conditions referred to above in assumption 1 due to minor equipment variations and statistical sampling error. Such values may be perfectly real, providing the auxiliary equipment introduces no errors.

In order to realize the benefits of Reference Ammunition, some rules must be adhered to. Nevertheless, each individual user must make the final judgments concerning how often it is used and the use of the data. It is important, therefore, that there be a clear realization of what it can and what it cannot tell the ammunition tester.

Reference Ammunition cannot guarantee the absolute accuracy of any test system. It does, however, provide simple and direct data from any given ammunition test equipment to determine how closely it relates to the acceptable, average system as used by SAAMI members.

In line with the preceding discussion, the following recommendations are made for the use of Reference ammunition:

- A. Each Reference Lot should be conditioned before use.
- B. How often Reference Ammunition is used shall be determined by the user's internal practices, taking into account such factors as historical knowledge of barrel life.
- C. The recommended minimum sample shall be ten rounds.
- D. In the event the observed average velocity and pressure of the sample falls within the *Inclusion Limits*, a correction may or may not be applied according to the procedure given in Step G at the discretion of the user.
- E. If one average is outside of the *Inclusion Limits* and the other within, the average that exceeds the limits shall be corrected according to the procedure given in Step G.
- F. If both averages are outside of the *Inclusion Limits*, both the velocity and pressure shall be corrected according to the procedure in Step G.
- G. If the correction is to be applied, the correction shall be the difference between the assessed value and the observed average of the test.

**REFERENCE AMMUNITION:
SECONDARY REFERENCE AMMUNITION**

Occasionally, a test station will have a need for a supply of Reference Ammunition exceeding the maximum recommended order quantity (see page 231). In order to minimize the premature exhaustion of any particular lot, it is suggested that the station create its own secondary reference lot to fill the special need.

A secondary reference lot should consist of a supply of off-the-shelf ammunition, each box bearing the same manufacturer's lot code/lot number. The secondary reference lot should be approximately equivalent in bullet weight, average velocity, and average pressure to the Reference Ammunition that it replaces.

REFERENCE AMMUNITION: NEW LOTS

I. GENERAL

Reference Ammunition lots have been established for those lots or loads designated by the Technical Committee. Responsibility for production of each of the selected lots is assigned to a member company that is responsible for maintaining a supply. A five-year supply is recommended. It is desirable that Reference Ammunition be consistent with Manual values for that particular round.

When a producer has prepared a new lot, it shall be his responsibility to announce the lot to the SAAMI Technical Office⁷, giving a tentative assessment and other data. (An example of the recommended format for this announcement appears later in this subsection.)

The producer shall supply for immediate testing, at the time of the announcement of the new lot, to each member of the Reference Ammunition Group that has the capability to test that cartridge:

- Twenty (20) rounds for cartridges with pressure guidelines established only in the piezoelectric transducer pressure measurement system.
- Thirty (30) rounds for cartridges with pressure guidelines established only in the copper crusher pressure measurement system.
- Fifty (50) rounds for cartridges with pressure guidelines established in both pressure measurement systems (copper crusher and piezoelectric transducer)

A current list of the testing capabilities of the Reference Ammunition Group is available from the SAAMI Technical Office on request.

The SAAMI Technical Office will announce the availability of the new lot to the participating ranges, giving the tentative assessment and other pertinent data. (An example of the recommended format for this announcement appears later in this subsection.)

II. METHOD OF ASSESSMENT

Before announcing a new lot of reference ammunition to the SAAMI Technical Office, the manufacturer should make sufficient tests to determine Tentative Values of pressure and velocity for the new lot.

It is recommended the establishment of a Tentative Assessment be based on testing using as many test barrels as practicable and, if possible and applicable, using multiple pressure transducers. The use of multiple barrels/transducers strengthens the statistical validity of the assessment by including additional sources of routine variation in the mean values. Results from each unique combination of barrel / transducer should be reported separately on the announcement. (See page 197.)

1. The test barrels shall conform to the SAAMI specifications for internal dimensions, length and piston / piezo gauge location. (Refer to Section III of this document.)

⁷ Refer to Section III, page 233 for current contact information for the SAAMI Technical Office.

2. Counter-chronographs and photoelectric screens shall be used in velocity measurements. (See Section III.)
3. Ammunition shall be conditioned for a minimum of 24 hours at $70^{\circ} \pm 2^{\circ}$ F ($21.1^{\circ} \pm 1.1^{\circ}$ C) with relative humidity of $60\% \pm 5\%$ before firing.
4. For copper crusher assessments, only an approved crusher lot shall be used in pressure measurements. (See Section III, page 203 for proper crusher sizes.)

NEW REFERENCE LOT REPORTING FORM AND INSTRUCTIONS

These instructions pertain to the form shown in Section II, which is used for a Reference Ammunition producer to announce new lots to the SAAMI Technical Office, as well as for the SAAMI Technical Office to announce the new lot to participating ranges.

SUBJECT: T-4010 Reference Ammunition – Centerfire Rifle
New Reference Lot

TO: *When used by a producer:*
SAAMI Technical Office⁸

When used by SAAMI Technical Office to notify test stations:
Current address of all stations and personnel.

(1) Name and address of source
for procurement as shown
in Section III

SIGNED: Authorized Person
Producer Company Name
Address (including zip
code)

DATE:

⁸ Refer to Section III, page 233 for current contact information for the SAAMI Technical Office.

ANNOUNCEMENT OF NEW REFERENCE AMMUNITION LOT

SUBJECT: T-4010 Reference Ammunition – Centerfire Rifle
 New Reference Lot

TO:

CARTRIDGE _____ Lot No. _____

Replacing Lot No. _____ Order Symbol _____

- TENTATIVE ASSESSMENT -

* CRUSHER *					
		VELOCITY LONG Piston (fps)		PRESSURE SHORT Piston (CUP in units of 100)	
Bbl # _____	Mfr _____	_____ fps	σ: _____	_____ CCUP	σ: _____
Bbl # _____	Mfr _____	_____ fps	σ: _____	_____ CCUP	σ: _____
Bbl # _____	Mfr _____	_____ fps	σ: _____	_____ CCUP	σ: _____
Bbl # _____	Mfr _____	_____ fps	σ: _____	_____ CCUP	σ: _____
Bbl # _____	Mfr _____	_____ fps	σ: _____	_____ CCUP	σ: _____
GRAND AVERAGE: _____ fps			GRAND AVERAGE: _____ CCUP		
* TRANSDUCER *					
		VELOCITY (fps)		PRESSURE (psi in units of 100)	
Bbl # _____	Mfr _____	_____ fps	σ: _____	_____ Cpsi	σ: _____
Bbl # _____	Mfr _____	_____ fps	σ: _____	_____ Cpsi	σ: _____
Bbl # _____	Mfr _____	_____ fps	σ: _____	_____ Cpsi	σ: _____
Bbl # _____	Mfr _____	_____ fps	σ: _____	_____ Cpsi	σ: _____
Bbl # _____	Mfr _____	_____ fps	σ: _____	_____ Cpsi	σ: _____
GRAND AVERAGE: _____ fps			GRAND AVERAGE: _____ Cpsi		

Please test the ammunition and report the results to the SAAMI Technical Office on the proper form (CFR Section II) as soon as possible.

SIGNED: _____

DATE: _____

REFERENCE AMMUNITION: IDENTIFICATION PROTOCOL

SAAMI Reference Ammunition

This ammunition is to be used only for calibration
of test gauges for velocity and pressure.

LOT NUMBERING SYSTEM (Typical numbers)

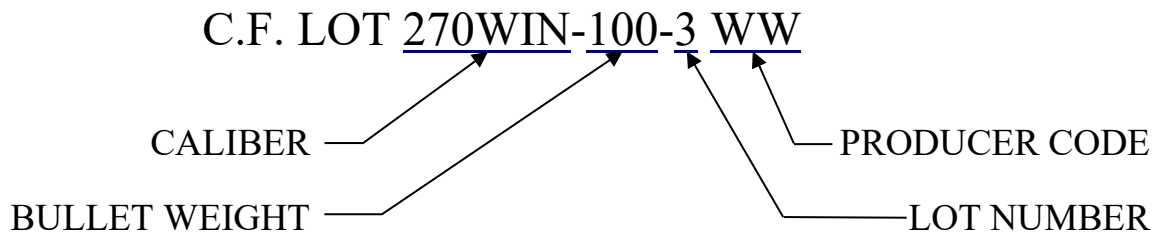

PRODUCER CODES

A — *A-Square OBSOLETE*

B — *Blount (ATK Ammunition & Accessories) OBSOLETE*

BB — *Barnes Bullets, LLC OBSOLETE*

CS = CCI/Speer

F = Federal Cartridge Co.

FIO = FIOCCHI USA

H = Hornady Manufacturing

N = Nosler, Inc.

NP = Norma USA

R = Remington Ammunition

RG — *Ruag Ammotec OBSOLETE*

SIG = SIG SAUER Ammunition

TVA = True Velocity Ammunition

WBY = Weatherby, Inc

WW = Winchester-Western Div., Olin Corporation

NOTE

BLACK LETTERING

REFERENCE AMMUNITION: PERIODIC ASSESSMENT

I. PROCUREMENT

Reference ammunition is procured as noted in Section III.

II. PERIODIC TESTS

A. STATIONS

1. All test conditions should conform as closely as possible to those prescribed in this Manual, and the following conditions should be met:
 - a) Tests should consist of ten (10) rounds for velocity and pressure fired during a single day.
 - b) Test barrels shall conform to SAAMI specifications for internal dimensions, length, and piston/transducer location.
 - c) Counter-chronographs and photoelectric screens (or equivalents) shall be used in velocity measurements. (See Section III.)
 - d) Ammunition shall be conditioned for 72 hours at $70^{\circ} \pm 2^{\circ}$ F ($21.1^{\circ} \pm 1.1^{\circ}$ C) with relative humidity of $60\% \pm 5\%$ before firing.
 - e) Only an approved crusher lot and/or transducer shall be used in pressure measurements. (See Section III, page 203 for proper crusher sizes.)
2. Each station should report results of its firing in the test on approved forms to the SAAMI Technical Office⁹. A sample of this report form is presented later in this subsection.

B. CLEARINGHOUSE

1. The SAAMI Technical Office serves as the clearinghouse for all Reference Ammunition ballistics and related information. It shall be the responsibility of the SAAMI Technical Office to schedule testing and to assemble and distribute results of periodic tests. This should be done on the proper Reference Ammunition report form, a sample of which appears in this subsection.
2. The Reference Ammunition Report shall contain the average pressure, velocity, and related standard deviations as reported by each station for that lot. From this data, the SAAMI Technical Office will calculate and report the *Raw Average*, *Corrected Average*, and *Inclusion Limits*.
3. To obtain the *Raw Averages*, the SAAMI Technical Office shall include the 10-round averages for the pressure and velocity of all tests from reporting stations and the first and second previous assessment value, if applicable. If the 10-round

⁹ Refer to Section III, page 233 for current contact information for the SAAMI Technical Office.

average from any test from any station varies from the *Raw Average* by more than plus or minus 50 fps in velocity OR plus or minus 3,500 CUP/psi in pressure, the pressure or velocity data from that (those) test(s) should be discarded. The mean pressure and velocity data should be recalculated omitting the discarded data. The new mean is the *Corrected Average*. If the mean pressure value of a test is outside the limits as defined above, but the velocity is in, the pressure data should be dropped and the velocity data retained. The converse is true as well. Using the *Corrected Averages*, the *Inclusion Limits* are determined as follows:

VELOCITY: MEAN = Same as Corrected Average
 HIGH = MEAN + 50 fps
 LOW = MEAN – 50 fps

PRESSURE: MEAN = Same as Corrected Average
 HIGH = MEAN + 3,500 CUP/psi
 LOW = MEAN – 3,500 CUP/psi

NOTE: In the event a test station reports results for more than one test barrel, such as for a new reference lot tentative assessment, the results from each barrel shall be included and treated as if coming from a separate test station. Results from multiple test barrels shall NOT be averaged together prior to being entered.

T-4010 STATION REPORT
 REFERENCE AMMUNITION – PERIODIC ASSESSMENT
 CENTERFIRE RIFLE

STATION _____

SAAMI REFERENCE LOT _____

DATE _____

PREVIOUS ASSESSMENT

Velocity _____

Pressure Barrel No. _____

Pressure _____

Rounds to-date _____

Velocity Barrel No. _____

Type of Gauge: _____

Rounds to-date _____

Gauge S/N: _____

	VELOCITY	PRESSURE
1.		
2.		
3.		
4.		
5.		
6.		
7.		
8.		
9.		
1.		
AVERAGE		
OFFSET		
FINAL AVERAGE		
$\sigma_{(\eta-1)\square}$		

TECHNICAL SERVICES REPORT – REFERENCE AMMUNITION

PERIODIC ASSESSMENT – CF Rifle

MAY – 2015

LOT NO: 30CARB-110-5WW

GAGE: CRUSHER

	<u>VELOCITY</u>	σ	<u>PRESSURE</u>	σ
CCI/Speer	2,036	15.0	372	11.8
Federal	1,983	21.0	334	9.4
Hodgdon	2,015	5.0	412	17.2
Hornady Manufacturing	2,044	11.0	365	13.5
New River Energetics	2,004	14.0	328	1.0
Nosler	2,020	12.5	378	11.7
Remington – Lonoke	2,014	22.0	371	1.1
St. Marks Powder	2,046	1.0	370	28.0
Winchester	1,975	8.6	337	17.9

1 st Previous Average	2,016		356	
2 nd Previous Average	2,013		350	

	<u>VELOCITY</u>	σ	<u>PRESSURE</u>	σ
Raw Average	2,015		361	
Corrected Average	2,015		356	

Inclusion Limits @ 99.95%

Upper Limit	2,065		391	
Lower Limit	1,965		321	

ASSESSMENT 2,015 356

EQUIPMENT: VELOCITY & PRESSURE TESTING

NOTE: Refer to the SAAMI website (saami.org) for detailed information on contacting the manufacturers of listed products and the SAAMI Technical Office.

1. Equipment common to Crusher and Piezoelectric Transducer Testing

- a) **Universal Receiver** – A holding fixture providing a fire control mechanism and capable of receiving test barrels made in accordance with the drawings presented in Section III – Equipment with sufficient rigidity to provide accurate and repeatable results when performing both velocity & pressure and accuracy testing. Optionally, this device may be equipped with a switch or other triggering device to facilitate a timer start signal for the measurement of various time features of the ballistic cycle.
- b) **Photoelectric screens** – Sensing devices capable of detecting the passage of bullets in flight and providing an electronic pulse, trigger, or other output to control the starting/stopping of an electronic counter chronograph for time of flight/average velocity. Typically, these devices rely on a visible or infrared light source to create a curtain of light through which the bullet travels, causing a shadow to fall on an array of sensors and cause the trigger pulse.
- c) **Electronic Counter Chronograph** – An electronic counter chronograph capable of measuring time intervals up to 5 seconds, minimum, at 100 kilohertz, minimum (10 μ S) precision and with remote start/stop inputs.
- d) Table of velocity vs. time of flight or electronic calculator.

NOTE: Items (c) and (d) may be replaced by a direct-reading velocity chronograph or integrated ballistic instrumentation system with equivalent accuracy and precision.

- e) **Test Barrels** – Velocity/accuracy test barrels and velocity/pressure test barrels made in accordance with the drawings presented in Section III – Equipment.
- f) **Reference ammunition** - Primary or secondary

2. Equipment for Copper Crusher Velocity & Pressure Testing

- a) **Pistons**, Long and Short – Made in accordance with the lengths detailed by caliber in Section III – Equipment.
- b) **Gas Checks** – Made in accordance with drawing in Section III.
- c) **Oil** - SAE 30, any service rating.
- d) **Gas check tools**, seating and knockout – Made in accordance with drawing in Section III.
- e) **Gas check wax** – Made in accordance with instructions in Section III.
- f) **Copper crushers** – Made in accordance with the drawings and description in Section III.
 - .146” x .400”
 - .225” x .400”
- g) **Measuring device** for compressed crushers
 - 1) Micrometer, .500” capacity, minimum, .0005” precision.
 - 2) Platform dial indicator, .500” capacity, minimum, .0005” precision.
 - 3) Other device capable of measuring lengths up to .500” with a minimum precision of .0005”
- h) **Tarage table** (supplied with each lot of crushers; see Section III for sample tables)

- .146” x .400” when used with .146” piston; data presented in .0005” increments of compressed length representing pressure levels from 9,400 – 60,000 CUP, minimum.
- .146” x .400” when used with .206” piston; data presented in .0005” increments of compressed length representing pressure levels from 4,700 – 30,000 CUP, minimum.
- .225” x .400” when used with .206” piston; data presented in .001” increments of compressed length representing pressure levels from 13,000 – 95,000 CUP, minimum.

3. Equipment for Conformal Piezoelectric Transducer Velocity & Pressure Testing

- a) **Charge amplifier** – A signal amplifier and conditioner for piezoelectric transducer outputs incorporating a selectable low pass filter and adjustable charge input range from .0001 to 10 V/pC, max charge input range of 100,000 pC, including short, medium, and long discharge time constant settings up to 100,000 seconds, with a remote reset.
- b) **Voltmeter, Peak capture** – An analog or digital peak-capturing voltmeter capable of handling input voltages of 10 VDC maximum, and 20 kHz filter. When digital, with a sampling rate of 200 KHz (5 μS), minimum, with a 10-bit (or greater) resolution for a 10 VDC maximum input.
- c) **Conformal Pressure Transducer** – A quartz piezoelectric pressure sensor for converting pressure changes into electrical signals, with a concave diaphragm conforming to the curvature and taper of the cartridge case. The sensor requires an alignment guide providing precise rotational alignment and permitting depth adjustment of the diaphragm.
- d) **Low Noise Cable** – Coaxial cable, made with low noise graphite barriers over conductor and conductor insulator, fitted with appropriate connectors to attach to the *Conformal Pressure Transducer* (c) and the *Charge Amplifier* (a).

USAGE OF CRUSHER CYLINDERS IN PRESSURE TESTING

Copper crusher cylinders manufactured and qualified in accordance with SAAMI guidelines and of the nominal sizes listed below shall be used for pressure tests of centerfire rifle cartridges.

Crusher cylinders shall not be pre-compressed before use.

Sample tarage tables are shown on pages 204 and 205 for illustrative purposes; only the tarage table furnished with a particular lot of cylinders should be used.

Designation	Nominal Size	PISTON		Average Pressure Limits
		Diameter	Area	(CUP/100)
A	.146" x .400"	.206"	1/30 inch ²	Less than 240
C	.225" x .400"	.206"	1/30 inch ²	240 and greater

It is recommended that pressures be recorded in “Copper Units of Pressure”, or “CUP”.*

* - The designation “Copper Units of Pressure” (“CUP”) was adopted by the Technical Committee at their meeting of January 8, 1969, to replace the previous designation of “pounds per square inch.” Advances in the art of pressure-sensing devices had shown that pressures recorded by deformation of copper crusher cylinders are not necessarily a true measure of pounds per square inch for the transient phenomena encountered in sporting arms ammunition.

SAMPLE TARAGE TABLE
 COPPER CRUSHER CYLINDERS
 .146" DIAMETER, .400" LONG
 FOR USE WITH .206" DIAMETER PISTON
 AREA = 1/30 SQUARE INCH

*CUP in units of 100

<u>Final Length</u>	<u>Pressure CUP*</u>	<u>Final Length</u>	<u>Pressure CUP*</u>	<u>Final Length</u>	<u>Pressure CUP*</u>	<u>Final Length</u>	<u>Pressure CUP*</u>
.3995	14	.3795	102	.3595	155	.3395	219
.3990	20	.3790	103	.3590	156	.3390	221
.3985	25	.3785	105	.3585	157	.3385	223
.3980	30	.3780	106	.3580	158	.3380	225
.3975	33	.3775	108	.3575	159	.3375	227
.3970	35	.3770	109	.3570	160	.3370	229
.3965	38	.3765	111	.3565	161	.3365	231
.3960	41	.3760	112	.3560	162	.3360	233
.3955	44	.3755	114	.3555	163	.3355	235
.3950	46	.3750	115	.3550	164	.3350	237
.3945	49	.3745	117	.3545	165	.3345	239
.3940	51	.3740	118	.3540	166	.3340	241
.3935	53	.3735	120	.3535	167	.3335	243
.3930	55	.3730	121	.3530	168	.3330	245
.3925	57	.3725	122	.3525	169	.3325	247
.3920	59	.3720	123	.3520	170	.3320	249
.3915	61	.3715	125	.3515	172	.3315	251
.3910	63	.3710	126	.3510	173	.3310	253
.3905	65	.3705	127	.3505	174	.3305	255
.3900	67	.3700	128	.3500	175	.3300	257
.3895	69	.3695	130	.3495	177	.3295	259
.3890	70	.3690	131	.3490	179	.3290	261
.3885	72	.3685	133	.3485	181	.3285	263
.3880	73	.3680	134	.3480	183	.3280	265
.3875	75	.3675	136	.3475	185	.3275	267
.3870	76	.3670	137	.3470	187	.3270	269
.3865	78	.3665	138	.3465	189	.3265	271
.3860	80	.3660	139	.3460	192	.3260	273
.3855	82	.3655	141	.3455	194	.3255	275
.3850	83	.3650	142	.3450	196	.3250	277
.3845	85	.3645	143	.3445	198	.3245	279
.3840	87	.3640	144	.3440	200	.3240	281
.3835	89	.3635	146	.3435	202	.3235	283
.3830	91	.3630	147	.3430	204	.3230	285
.3825	93	.3625	148	.3425	206	.3225	287
.3820	94	.3620	149	.3420	209	.3220	289
.3815	96	.3615	150	.3415	211	.3215	291
.3810	97	.3610	151	.3410	213	.3210	293
.3805	99	.3605	153	.3405	215	.3205	295
.3800	100	.3600	154	.3400	217	.3200	297

NOTE: Tarage tables are established for each lot of cylinders. Only the table furnished by the manufacturer with each shipment of cylinders should be used.

SAMPLE TARAGE TABLE
 COPPER CRUSHER CYLINDERS
 .225" DIAMETER, .400" LONG
 FOR USE WITH .206" DIAMETER PISTON
 AREA = 1/30 SQUARE INCH

*CUP in units of 100

<u>Final Length</u>	<u>Pressure CUP*</u>	<u>Final Length</u>	<u>Pressure CUP*</u>	<u>Final Length</u>	<u>Pressure CUP*</u>	<u>Final Length</u>	<u>Pressure CUP*</u>
.399	30	.359	383	.319	590	.279	783
.398	60	.358	390	.318	595	.278	787
.397	78	.357	395	.317	600	.277	792
.396	96	.356	400	.316	605	.276	797
.395	106	.355	405	.315	610	.275	802
.394	117	.354	411	.314	614	.274	807
.393	127	.353	416	.313	619	.273	812
.392	138	.352	421	.312	623	.272	816
.391	150	.351	427	.311	628	.271	821
.390	158	.350	433	.310	633	.270	826
.389	167	.349	438	.309	637	.269	831
.388	175	.348	444	.308	642	.268	836
.387	184	.347	450	.307	647	.267	840
.386	193	.346	455	.306	651	.266	845
.385	202	.345	460	.305	656	.265	850
.384	211	.344	466	.304	661	.264	855
.383	219	.343	471	.303	666	.263	860
.382	226	.342	477	.302	670	.262	864
.381	234	.341	483	.301	675	.261	869
.380	241	.340	488	.300	680	.260	874
.379	248	.339	493	.299	685	.259	879
.378	255	.338	497	.298	690	.258	884
.377	263	.337	502	.297	695	.257	888
.376	270	.336	507	.296	700	.256	893
.375	277	.335	511	.295	705	.255	898
.374	284	.334	516	.294	710	.254	903
.373	290	.333	521	.293	715	.253	908
.372	297	.332	526	.292	720	.252	913
.371	304	.331	531	.291	725	.251	917
.370	311	.330	535	.290	729	.250	922
.369	318	.329	540	.289	734		
.368	325	.328	545	.288	739		
.367	332	.327	550	.287	744		
.366	339	.326	555	.286	749		
.365	345	.325	560	.285	754		
.364	351	.324	565	.284	759		
.363	358	.323	570	.283	764		
.362	364	.322	575	.282	768		
.361	370	.321	580	.281	773		
.360	376	.320	585	.280	778		

NOTE: Tarage tables are established for each lot of cylinders. Only the table furnished by the manufacturer with each shipment of cylinders should be used.

**CRUSHER CYLINDERS:
DIMENSIONS – .146” x .400”**

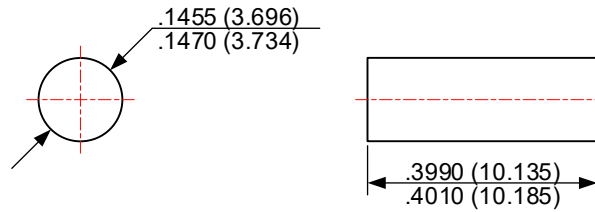

NOTES

1. Material: Copper UNS 10200 Alloy
(formerly known as Copper Development Association Alloy 102)
2. (XX.XX) = Millimeters

**CRUSHER CYLINDERS:
DIMENSIONS – .225” x .400”**

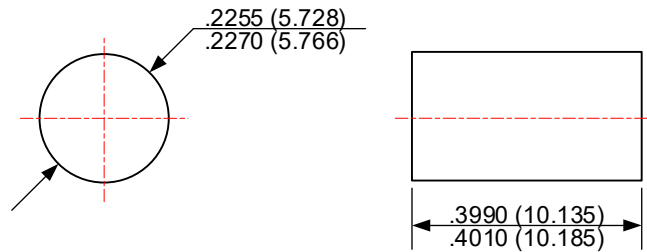

NOTES

1. Material: Copper UNS 10200 Alloy
(formerly known as Copper Development Association Alloy 102)
2. (XX.XX) = Millimeters

**EQUIPMENT:
.146" AND .206" GAS CHECKS**

.146" GAS CHECK

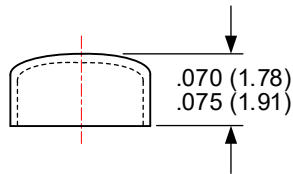
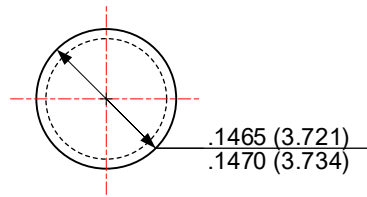

Material Thickness
.0095 – .0105 (.241 – .267)

.225" GAS CHECK

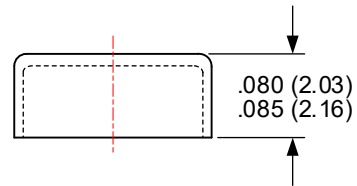
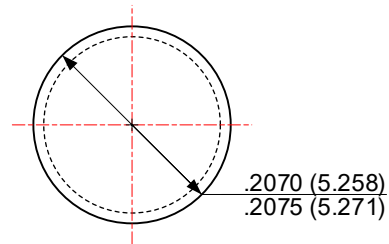

Material thickness
.0110 – .0115 (.279 – .292)

NOTES

1. Material – Copper UNS 21000 Alloy
(formerly known as Copper Development Association Alloy 210)
Grain size – .015 – .030 mm
2. (X.XXX) = Millimeters

**EQUIPMENT:
 GAS CHECK TOOLS – SEATING AND KNOCKOUT**

SEATING TOOL

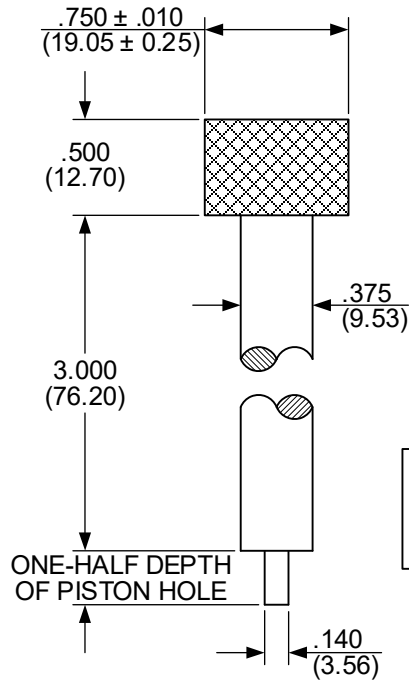

KNOCKOUT TOOL

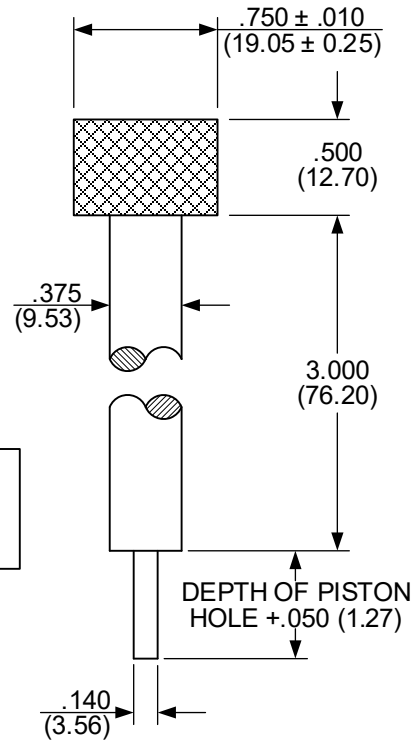

END DETAIL FOR USE
 WITH .146" PISTON
 HOLES

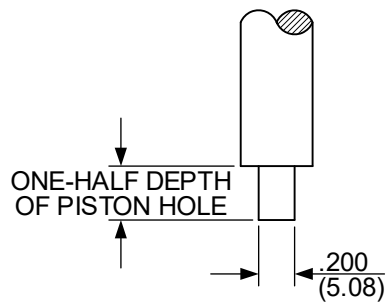

END DETAIL FOR USE
 WITH .206" PISTON
 HOLES

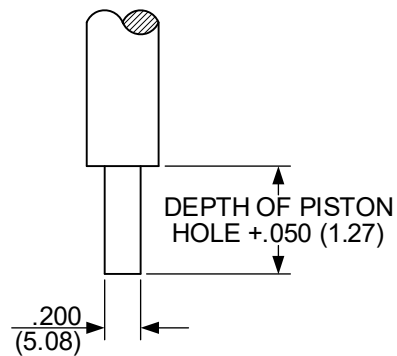

NOTES

1. Material – Copper UNS 26000 Alloy
 (formerly known as Copper Development Association Alloy 260)
2. Unless otherwise noted, all tolerances $\pm .002$ (.05)
3. (XX.XX) = Millimeters

**EQUIPMENT:
 PISTONS AND PISTON HOLES**

**SHORT PISTON
 (PRESSURE TESTING)**

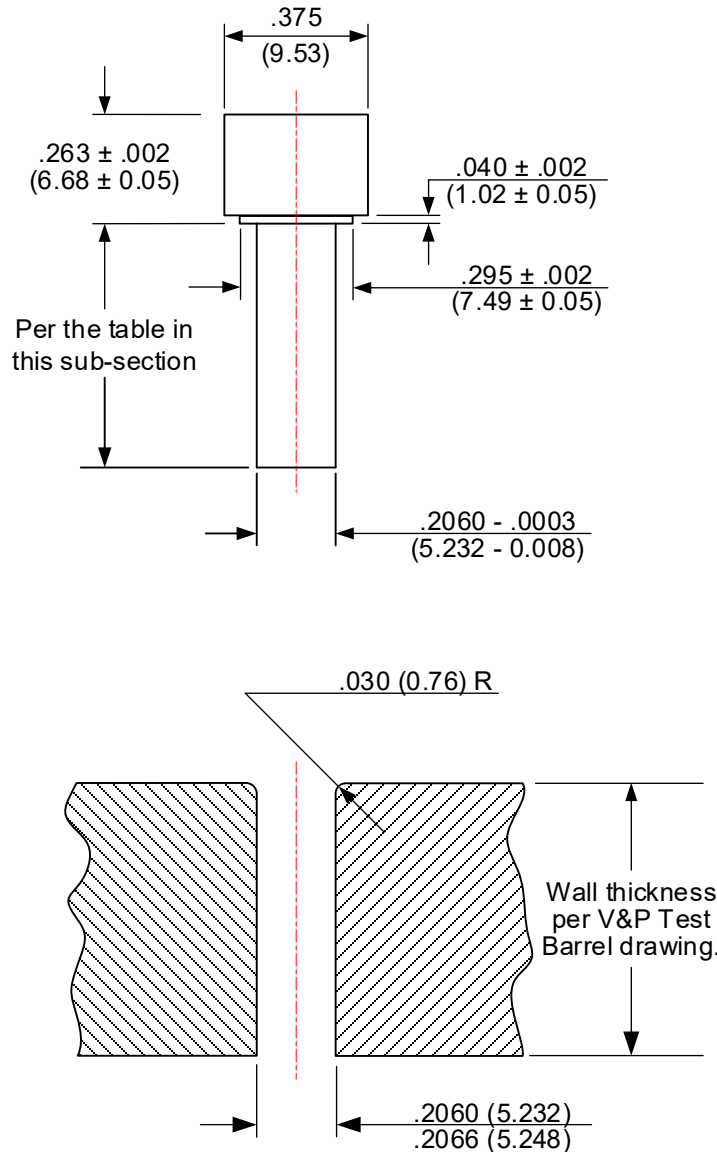

NOTES:

1. Material – High carbon steel – heat treat R_c 62-63
2. Pistons to be suction fit in piston holes.
3. (XX.XX) = Millimeters.

**LONG PISTON
 (VELOCITY TESTING)**

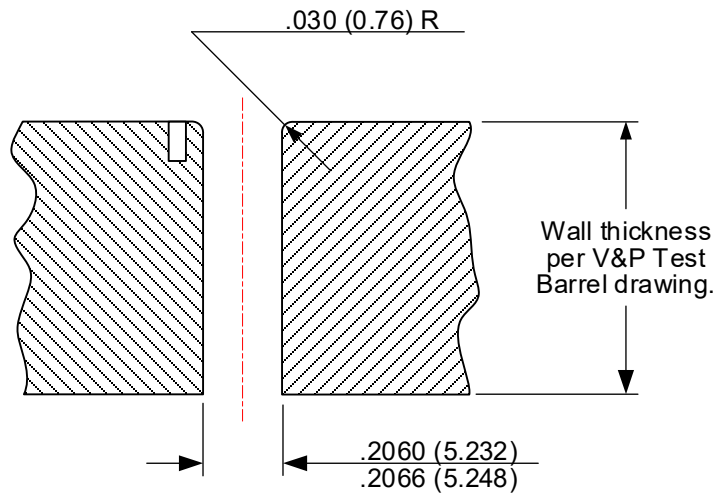
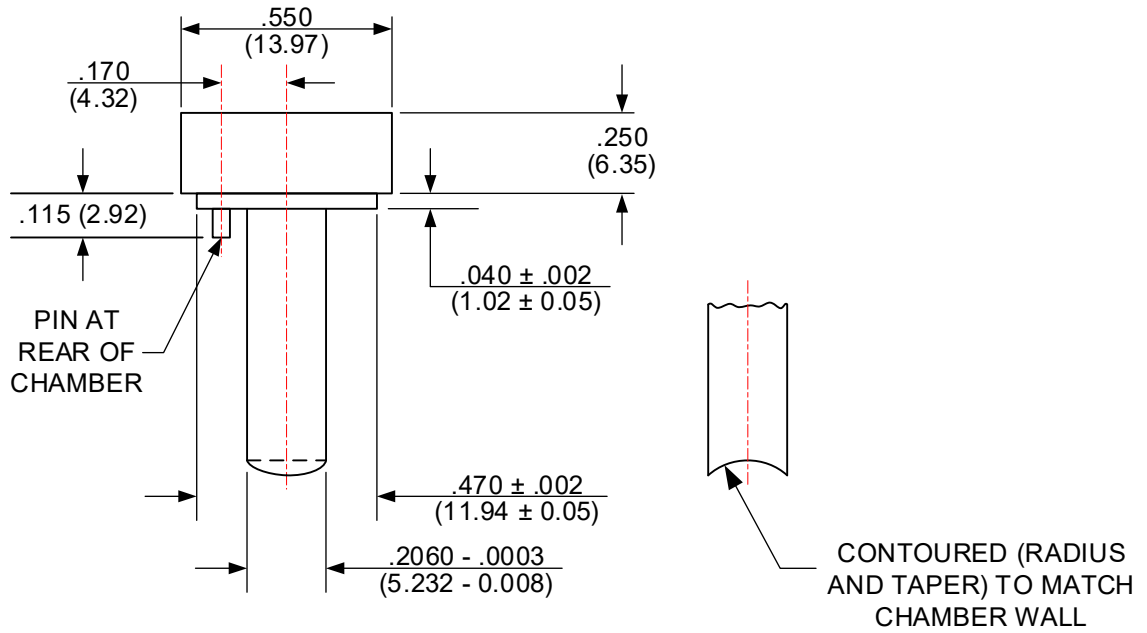

NOTES:

1. Material – High carbon steel – heat treat R_c 62-63
2. Pistons to be suction fit in piston holes.
3. (XX.XX) = Millimeters.

Due to the variation in the distance from the chamber wall to the outside edge of the test barrel caused by variation in cartridge diameters, “short” (pressure measurement) pistons for different cartridges are required to be different lengths. This table presents the appropriate short piston lengths for test barrels made in accordance with the drawings and other requirements in Section III.

Cartridge	Piston Diameter		Piston Length Recommendation	
	Inches	mm	Inches	mm
6mm Advanced Rifle Cartridge	N/E ¹			
6mm Creedmoor	N/E			
6mm GT	N/E			
6mm Remington	.206	5.23	.624	15.84
6.5 Creedmoor	N/E			
6.5 Grendel	N/E			
6.5 Precision Rifle Cartridge	N/E			
6.5 Weatherby Rebased Precision Magnum	N/E			
6.5-284 Norma	N/E			
6.5-300 Weatherby Magnum	N/E			
6.5 x 55 Swedish	.206	5.23	.621	15.77
6.8 True Velocity Composite	N/E			
6.8 Western	N/E			
6.8mm Remington SPC	N/E			
7mm Mauser (7 x 57)	.206	5.23	.624	15.84
7mm Precision Rifle Cartridge	N/E			
7mm Remington Magnum	.206	5.23	.602	15.29
7mm Remington Short Action Ultra Magnum	N/E			
7mm Remington Ultra Magnum	N/E			
7mm Weatherby Magnum	N/E			
7mm Winchester Short Magnum	N/E			
7mm-08 Remington	.206	5.23	.619	15.72
7 x 64 Brenneke	.206	5.23	.625	15.88
7.62 x 39	.206	5.23	.638	16.21
8mm Mauser (8 x 57)	.206	5.23	.623	15.83
9.3 x 62	N/E			
17 Hornet	N/E			
17 Remington	.206	5.23	.666	16.92
17 Remington Fireball	N/E			

¹ N/E = Not Established

Cartridge	Piston Diameter		Piston Length Recommendation	
	Inches	mm	Inches	mm
204 Ruger	N/E ¹			
218 Bee	.206	5.23	.681	17.30
22 Advanced Rifle Cartridge	N/E			
22 Creedmoor	N/E			
22 Hornet	.206	5.23	.708	17.98
22 Nosler	N/E			
22-250 Remington	.206	5.23	.630	16.01
220 Swift	.206	5.23	.637	16.19
221 Remington Fireball	.206	5.23	.666	16.91
222 Remington	.206	5.23	.666	16.92
222 Remington Magnum	.206	5.23	.666	16.91
223 Remington	.206	5.23	.666	16.90
223 Winchester Super Short Magnum	N/E			
224 Valkyrie	N/E			
243 Winchester	.206	5.23	.619	15.72
243 Winchester Super Short Magnum	N/E			
25 Winchester Super Short Magnum	N/E			
25-06 Remington	.206	5.23	.621	15.77
25-20 Winchester	.206	5.23	.681	17.29
25-35 Winchester	.206	5.23	.658	16.70
250 Savage	.206	5.23	.630	16.00
257 Roberts / 257 Roberts +P	.206	5.23	.624	15.84
257 Weatherby Magnum	.206	5.23	.601	15.26
26 Nosler	N/E			
260 Remington	.206	5.23	.619	15.72
264 Winchester Magnum	.206	5.23	.602	15.29
27 Nosler	N/E			
270 Weatherby Magnum	.206	5.23	.601	15.26
270 Winchester	.206	5.23	.621	15.77
270 Winchester Short Magnum	N/E			
277 SIG Fury	N/E			

¹ N/E = Not established.

Cartridge	Piston Diameter		Piston Length Recommendation	
	Inches	mm	Inches	mm
28 Nosler	N/E ¹			
280 Ackley Improved	N/E			
280 Remington	.206	5.23	.621	15.76
284 Winchester	.206	5.23	.606	15.38
30 Carbine	.206	5.23	.676	17.16
30 Nosler	N/E			
30 Remington AR	N/E			
30 Thompson Center	N/E			
30-06 Springfield	.206	5.23	.621	15.77
30-30 Winchester	.206	5.23	.645	16.38
30-40 Krag	.206	5.23	.630	16.00
300 AAC BLACKOUT	N/E			
300 HAM'R	N/E			
300 H&H Magnum	.206	5.23	.605	15.37
300 Norma Magnum	N/E			
300 Precision Rifle Cartridge	N/E			
300 Remington Short Action Ultra Magnum	N/E			
300 Remington Ultra Magnum	N/E			
300 Ruger Compact Magnum	N/E			
300 Savage	.206	5.23	.621	15.77
300 Weatherby Magnum	.206	5.23	.600	15.23
300 Winchester Magnum	.206	5.23	.602	15.29
300 Winchester Short Magnum	N/E			
303 British	.206	5.23	.633	16.09
307 Winchester	.206	5.23	.619	15.72
308 Marlin Express	N/E			
308 Winchester	.206	5.23	.619	15.72
32 Winchester Special	.206	5.23	.645	16.38
32-20 Winchester	.206	5.23	.677	17.20
325 Winchester Short Magnum	N/E			

¹ N/E = Not established.

Cartridge	Piston Diameter		Piston Length Recommendation	
	Inches	mm	Inches	mm
33 Nosler	N/E ¹			
338 Federal	N/E			
338 Lapua Magnum	N/E			
338 Marlin Express	N/E			
338 Norma Magnum	N/E			
338 Remington Ultra Magnum	N/E			
338 Ruger Compact Magnum	N/E			
338 Weatherby Rebated Precision Magnum	N/E			
338 Winchester Magnum	.206	5.23	.602	15.29
340 Weatherby Magnum	.206	5.23	.598	15.19
348 Winchester	.206	5.23	.600	15.23
35 Remington	.206	5.23	.629	15.98
35 Whelen	.206	5.23	.621	15.77
350 Legend	N/E			
356 Winchester	.206	5.23	.619	15.72
358 Winchester	.206	5.23	.619	15.72
360 Buckhammer	N/E			
370 Sako Magnum	N/E			
375 H&H Magnum	.206	5.23	.604	15.33
375 Remington Ultra Magnum	N/E			
375 Ruger	N/E			
375 Winchester	.206	5.23	.644	16.36
376 Steyr	N/E			
38-40 Winchester	.206	5.23	.620	15.75
38-55 Winchester	.206	5.23	.645	16.39
400 Legend	N/E			
405 Winchester	N/E			
416 Remington Magnum	.206	5.23	.602	15.29
416 Rigby	.206	5.23	.572	14.53
416 Ruger	N/E			
416 Weatherby Magnum	.206	5.23	.565	14.35

¹ N/E = Not established.

Cartridge	Piston Diameter		Piston Length Recommendation	
	Inches	mm	Inches	mm
44 Remington Magnum	.206	5.23	.621	15.78
44-40 Winchester	.206	5.23	.619	15.73
444 Marlin	.206	5.23	.618	15.70
45-70 Government	.206	5.23	.602	15.29
450 Bushmaster	N/E ¹			
450 Marlin	N/E			
458 Lott	.206	5.23	.604	15.35
458 Winchester Magnum	.206	5.23	.603	15.31
470 Nitro Express	.206	5.23	.578	14.68
500 Nitro Express 3"	N/E			
	.206	5.23	.578	14.68

¹ N/E = Not established.

**EQUIPMENT:
 PISTON HOLE GAUGES**

GAUGES FOR .146 DIAMETER PISTON HOLES

PLUG GAUGE

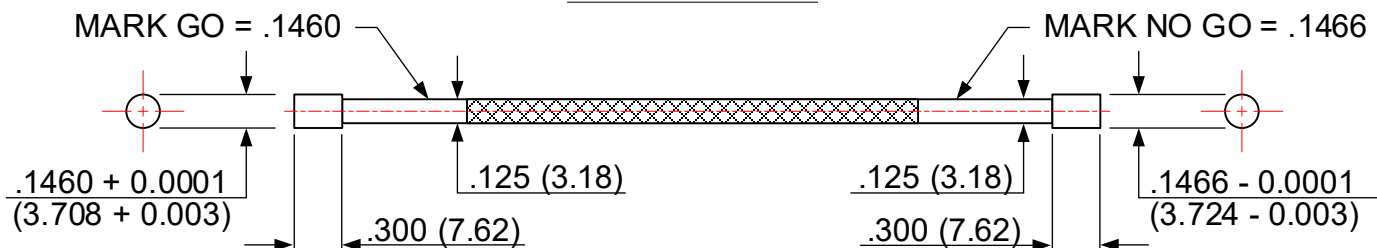

LONGITUDINAL GAUGE

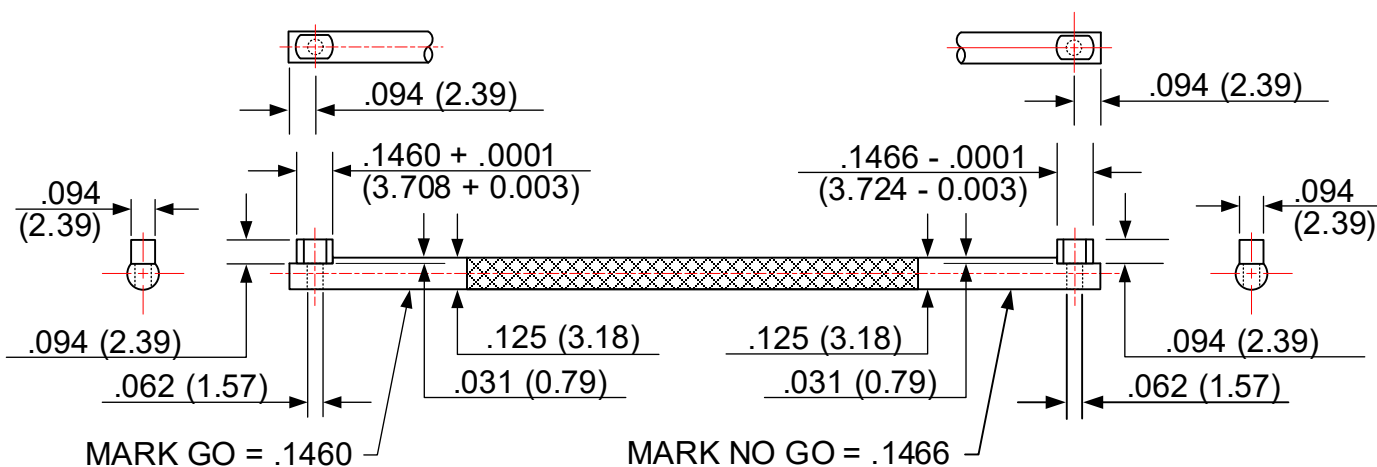

TRANSVERSE GAUGE

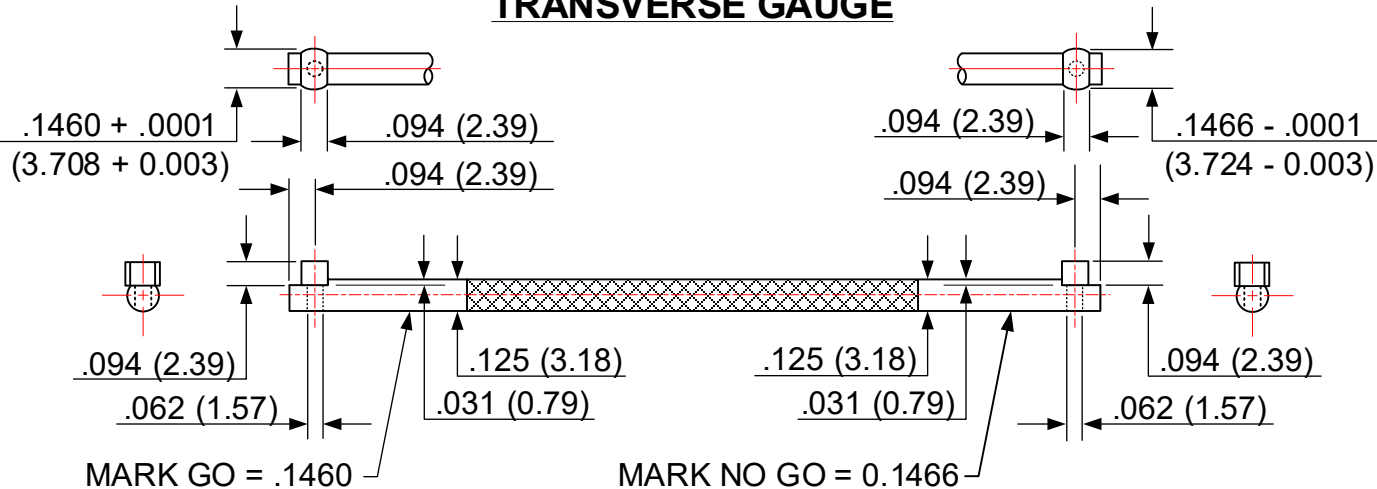

NOTES:

1. General tolerance ± 0.005 (0.13)
2. Material – Oil hard drill rod SAE-AISI O1 R_c 61-63
3. (XX.XX) = Millimeters

GAUGES FOR .206 DIAMETER PISTON HOLES

PLUG GAUGE

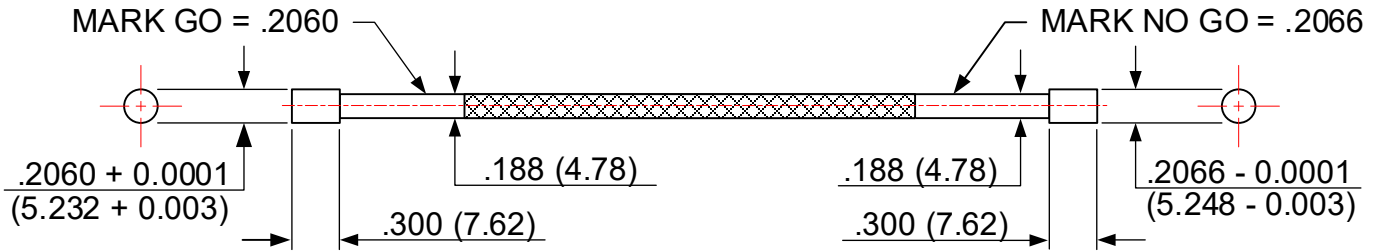

LONGITUDINAL GAUGE

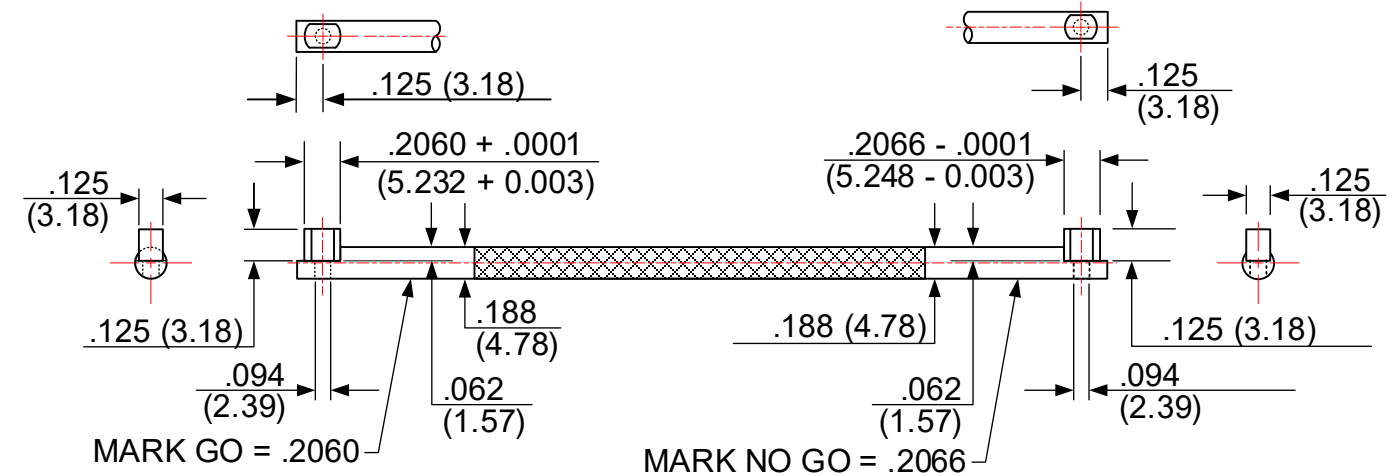

TRANSVERSE GAUGE

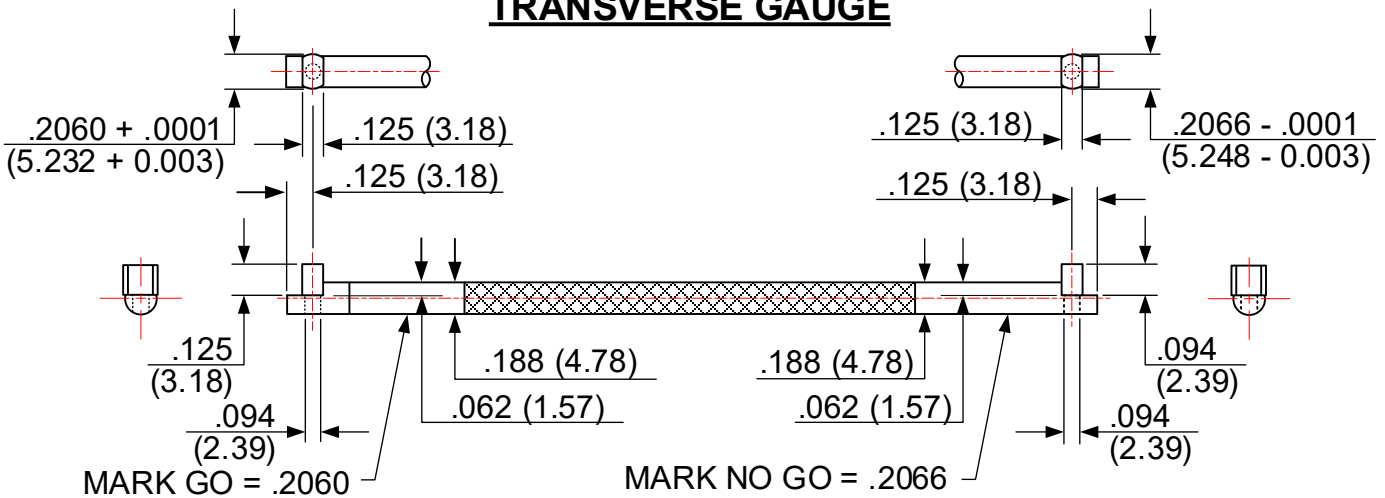

NOTES:

1. General tolerance ± 0.005 (0.13)
2. Material – Oil hard drill rod SAE-AISI O1 (T31501) R_c 61-63
3. (XX.XX) = Millimeters

PISTON OIL – PISTON AND GAS CHECK

It is recommended that pistons and gas checks (other than those filled with gas check wax) be lubricated with the following oil:

SAE 30 or equivalent

Viscosity at 210° F (98.9° C)

58 Saybolt seconds universal, minimum

70 Saybolt seconds universal, maximum

The oil should be of a non-detergent type.

HEADSPACE GAUGES

I. GAUGES FOR SHOULDER-BREECHING CARTRIDGES

FIGURE I
 SHOULDER-BREECHING CENTERFIRE RIFLE HEADSPACE GAUGES

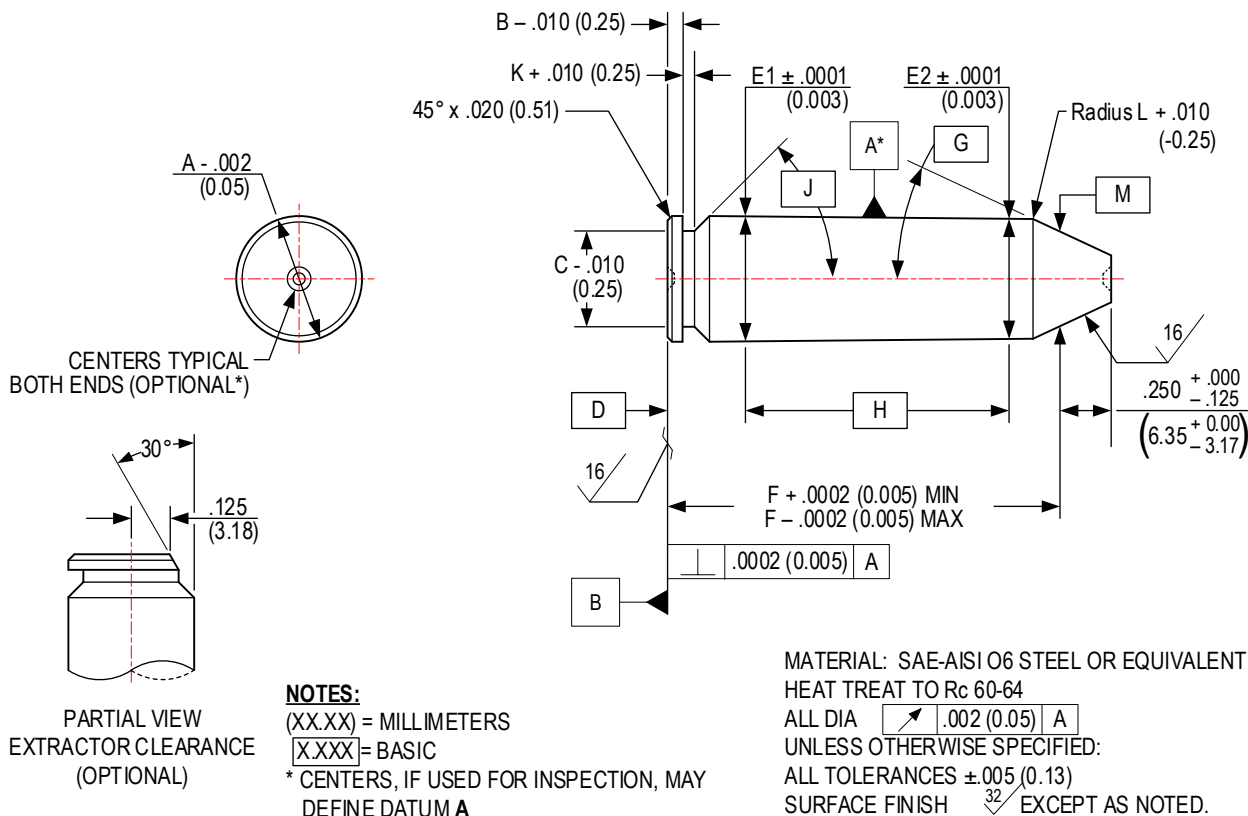

CARTRIDGE NAME	A	B	C	BASIC D	E1	E2	F		G	BASIC			BASIC M	
							MIN	MAX		H	J	K		L
6mm Advanced Rifle Cartridge	.441 (11.20)	.059 (1.50)	.376 (9.55)	.2000 (5.080)	.4421 (11.229)	.4320 (10.973)	1.1901 (30.229)	1.2001 (30.483)	30°	0.800 (20.32)	45°	.047 (1.19)	.040 (1.02)	.350 (8.89)
6mm Creedmoor	.472 (11.99)	.054 (1.37)	.409 (10.39)	.2000 (5.080)	.4709 (11.961)	.4634 (11.770)	1.5410 (39.141)	1.5510 (39.395)	30°	1.150 (29.21)	36°	.055 (1.40)	.040 (1.02)	.400 (10.16)
6mm GT	.471 (11.36)	.054 (1.37)	.409 (10.39)	.2000 (5.080)	.4705 (11.951)	.4605 (11.697)	1.3607 (34.562)	1.3707 (34.816)	35°	1.000 (25.40)	36°	.055 (1.40)	.040 (1.02)	.375 (9.53)
6mm Remington	.473 (12.01)	.049 (1.24)	.408 (10.36)	.2000 (5.080)	.4719 (11.986)	.4323 (10.980)	1.7767 (45.128)	1.7867 (45.382)	26°	1.4750 (37.465)	34°	.037 (0.94)	.035 (0.89)	.375 (9.53)
6.5 Creedmoor	.472 (11.99)	.054 (1.37)	.409 (10.39)	.2000 (5.080)	.4709 (11.961)	.4634 (11.770)	1.5410 (39.141)	1.5510 (39.395)	30°	1.150 (29.21)	36°	.055 (1.40)	.040 (1.02)	.400 (10.16)
6.5 Grendel	.441 (11.20)	.059 (1.50)	.378 (9.60)	.2000 (5.080)	.4421 (11.229)	.4323 (10.980)	1.2201 (30.991)	1.2301 (31.245)	30°	0.800 (20.32)	45°	.047 (1.19)	.030 (0.76)	.350 (8.89)
6.5 Precision Rifle Cartridge	.532 (13.51)	.050 (1.27)	.475 (12.07)	.2000 (5.080)	.5325 (13.526)	.5171 (13.134)	1.6486 (41.874)	1.6586 (42.128)	30°	1.300 (33.02)	35°	.037 (0.94)	.040 (1.02)	.420 (10.67)
6.5 Weatherby Rebated Precision Magnum	.473 (12.01)	.054 (1.37)	.409 (10.39)	.2000 (5.080)	.5005 (12.713)	.4785 (12.154)	2.2090 (56.109)	2.2190 (56.363)	35°	1.650 (41.91)	40°	.040 (1.02)	.040 (1.02)	.400 (10.16)

I. GAUGES FOR SHOULDER-BREECHING CARTRIDGES (Cont'd)

CARTRIDGE NAME	A	B	C	BASIC D	E1	E2	F		G	BASIC			K	L	BASIC M
							MIN	MAX		H	J				
6.5-284 Norma (METRIC ORIGIN)	.473	.054	.4091	.200	.5006	.4766	1.8242	1.8342	35°	1.500	40°	.040	.040	.400	
	(12.01)	(1.37)	(10.39)	(5.08)	(12.715)	(12.106)	(46.335)	(46.589)		(38.10)		(1.02)	(1.02)	(10.16)	
6.5 x 55 Swedish Mauser	.4803	.059	.4134	.200	.4789	.4373	1.7834	1.7934	25°	1.450	45°	.036	.112	.365	
	(12.200)	(1.50)	(10.500)	(5.08)	(12.164)	(11.107)	(45.298)	(45.552)		(36.83)		(0.90)	(2.84)	(9.27)	
6.8 Western	.535	.054	.480	.200	.5558	.5399	1.6460	1.6560	35°	1.300	45°	.040	.040	.445	
	(13.59)	(1.37)	(12.19)	(5.08)	(14.117)	(13.713)	(41.808)	(42.062)		(33.02)		(1.02)	(1.02)	(11.30)	
6.8mm Remington SPC	.422	.049	.358	.200	.4215	.4040	1.3460	1.3560	23°	1.000	36°	.033	.040	.360	
	(10.72)	(1.24)	(9.09)	(5.08)	(10.706)	(10.262)	(34.188)	(34.442)		(25.40)		(0.84)	(1.02)	(9.14)	
7mm Mauser	.473	.049	.409	.200	.4718	.4328	1.7947	1.8047	20°39'	1.450	32°	.033	.040	.375	
	(12.01)	(1.24)	(10.39)	(5.08)	(11.984)	(10.993)	(45.585)	(45.839)		(36.83)		(0.84)	(1.02)	(9.53)	
7mm Precision Rifle Cartridge	.532	.050	.475	.200	.5325	.5195	1.9000	1.9100	30°	1.500	35°	.034	.030	.420	
	(13.51)	(1.27)	(12.07)	(5.08)	(13.526)	(13.195)	(48.260)	(48.514)		(38.10)		(0.86)	(0.76)	(10.67)	
7mm Remington Short Action Ultra Magnum	.534	.050	.475	.200	.5505	.5362	1.5990	1.6090	30°	1.250	32°	.037	.040	.460	
	(13.56)	(1.27)	(12.07)	(5.08)	(13.983)	(13.619)	(40.615)	(40.869)		(31.75)		(0.94)	(1.02)	(11.68)	
7mm Remington Ultra Magnum	.534	.050	.475	.200	.5505	.5305	2.4742	2.4842	30°	1.750	32°	.037	.040	.420	
	(13.56)	(1.27)	(12.07)	(5.08)	(13.983)	(13.475)	(62.845)	(63.099)		(44.45)		(0.94)	(1.02)	(10.67)	
7mm Winchester Short Magnum	.535	.054	.480	.200	.5558	.5408	1.7640	1.7740	35°	1.300	45°	.040	.060	.445	
	(13.59)	(1.37)	(12.19)	(5.08)	(14.117)	(13.736)	(44.806)	(45.060)		(33.02)		(1.02)	(1.52)	(11.30)	
7mm-08 Remington	.473	.054	.409	.200	.4709	.4559	1.6300	1.6400	20°	1.250	36°	.055	.040	.400	
	(12.01)	(1.37)	(10.39)	(5.08)	(11.961)	(11.580)	(41.402)	(41.656)		(31.75)		(1.40)	(1.02)	(10.16)	
7 x 64 Brenneke	.4705	.051	.413	.200	.4656	.4297	2.0957	2.1057	20°15'	1.6500	36°52'	.039	.030	.375	
	(11.951)	(1.30)	(10.49)	(5.08)	(11.826)	(10.914)	(53.231)	(53.485)		(41.910)		(0.99)	(0.76)	(9.53)	
7.62 x 39	.447	.057	.376	.200	.4453	.4020	1.2520	1.2620	17°30'	.9083	48°	.047	.040	.3622	
	(11.35)	(1.45)	(9.55)	(5.08)	(11.311)	(10.211)	(31.801)	(32.055)		(23.071)		(1.19)	(1.02)	(9.200)	
8mm Mauser (8x57)	.473	.049	.409	.200	.4705	.4356	1.8743	1.8843	19°	1.500	36°	.033	.040	.392	
	(12.01)	(1.24)	(10.39)	(5.08)	(11.951)	(11.064)	(47.607)	(47.861)		(38.10)		(0.84)	(1.02)	(9.96)	
9.3 x 62 (METRIC ORIGIN) ¹⁵	.470	.051	.413	.200	.4761	.4520	2.0880	2.0980	17°32'33"	1.800	42°	.039	.020	.420	
	(11.95)	(1.30)	(10.50)	(5.08)	(12.093)	(11.481)	(53.034)	(53.288)		(45.72)		(1.00)	(0.50)	(10.67)	
17 Remington	.378	.045	.332	.200	.3764	.3589	1.3785	1.3885	23°	1.000	25°	.030	.035	.330	
	(9.60)	(1.14)	(8.43)	(5.08)	(9.561)	(9.116)	(35.014)	(35.268)		(25.40)		(0.76)	(0.89)	(8.38)	
17 Remington Fireball	.3804	.045	.358	.200	.3764	.3668	1.1175	1.1275	30°	.800	25°	.030	.025	.300	
	(9.662)	(1.14)	(9.09)	(5.08)	(9.561)	(9.317)	(28.639)	(28.639)		(20.32)		(0.76)	(0.64)	(7.62)	
204 Ruger	.378	.045	.332	.200	.3763	.3619	1.5613	1.5713	30°	1.200	25°	.030	.035	.330	
	(9.60)	(1.14)	(8.43)	(5.08)	(9.558)	(9.192)	(39.657)	(39.911)		(30.48)		(0.76)	(0.89)	(8.38)	
22 Advanced Rifle Cartridge	.441	.059	.378	.200	.4421	.4320	1.2201	1.2301	30°	.800	45°	.047	.040	.350	
	(11.20)	(1.50)	(9.60)	(5.08)	(11.229)	(10.973)	(30.991)	(31.245)		(20.32)		(1.19)	(1.02)	(8.89)	
22 Creedmoor	.472	.054	.409	.200	.4709	.4634	1.5410	1.5510	30°	1.150	36°	.055	.040	.400	
	(11.99)	(1.37)	(10.39)	(5.08)	(11.961)	(11.770)	(39.141)	(39.395)		(29.21)		(1.40)	(1.02)	(10.16)	
22 Nosler	.378	.045	.332	.200	.4212	.4037	1.4500	1.4600	30°	1.000	27°	.030	.035	.330	
	(9.60)	(1.14)	(8.43)	(5.08)	(10.698)	(10.254)	(36.830)	(37.084)		(25.40)		(0.76)	(0.89)	(8.38)	
22-250 Remington	.473	.049	.409	.200	.4676	.4179	1.5749	1.5849	28°	1.240	34°	.033	.035	.347	
	(12.01)	(1.24)	(10.39)	(5.08)	(11.877)	(10.615)	(40.002)	(40.256)		(31.50)		(0.84)	(0.89)	(8.81)	
220 Swift	.473	.049	.426	.200	.4453	.4058	1.8060	1.8160	21°	1.400	15°	.025	.040	.335	
	(12.01)	(1.24)	(10.82)	(5.08)	(11.311)	(10.307)	(45.872)	(46.126)		(35.56)		(0.64)	(1.02)	(8.51)	
221 Remington Fireball	.378	.045	.332	.200	.3764	.3625	1.1038	1.1138	23°	.800	25°	.030	.035	.330	
	(9.60)	(1.14)	(8.43)	(5.08)	(9.561)	(9.208)	(28.037)	(28.291)		(20.32)		(0.76)	(0.89)	(8.38)	
222 Remington	.378	.045	.332	.200	.3764	.3589	1.2936	1.3036	23°	1.000	25°	.025	.035	.330	
	(9.60)	(1.14)	(8.43)	(5.08)	(9.551)	(9.116)	(32.857)	(33.111)		(25.40)		(0.64)	(0.89)	(8.382)	
222 Remington Magnum	.378	.045	.378	.200	.3758	.3584	1.4925	1.5025	23°	1.200	25°	.030	.035	.330	
	(9.60)	(1.14)	(9.60)	(5.08)	(9.545)	(9.103)	(37.910)	(38.164)		(30.48)		(0.76)	(0.89)	(8.382)	

¹⁵ This design was originally created using metric dimensions. The US Customary values are converted from the source metric and rounded.

I. GAUGES FOR SHOULDER-BREECHING CARTRIDGES (Cont'd)

CARTRIDGE NAME	A	B	C	BASIC D	E1	E2	F		BASIC			K	L	BASIC M
							MIN	MAX	G	H	J			
223 Remington	.378	.045	.332	.200	.3764	.3589	1.4636	1.4736	23°	1.000	25°	.030	.035	.330
	(9.60)	(1.14)	(8.43)	(5.08)	(9.561)	(9.116)	(37.175)	(37.429)		(25.40)		(0.76)	(0.89)	(8.382)
223 Winchester Super Short Magnum	.535	.054	.480	.200	.5558	.5469	1.2403	1.2503	28°	.800	45°	.040	.060	.445
	(13.59)	(1.37)	(12.19)	(5.08)	(14.117)	(13.891)	(31.504)	(31.758)		(20.32)		(1.02)	(1.52)	(11.30)
224 Valkyrie	.422	.049	.358	.200	.4215	.4075	1.2550	1.2650	30°	.800	36°	.033	.035	.340
	(10.72)	(1.24)	(9.09)	(5.08)	(10.706)	(10.351)	(31.877)	(32.131)		(20.32)		(0.84)	(0.89)	(8.64)
243 Winchester	.473	.054	.409	.200	.4709	.4559	1.6300	1.6400	20°	1.250	36°	.055	.040	.400
	(12.01)	(1.37)	(10.39)	(5.08)	(11.961)	(11.580)	(41.402)	(41.656)		(31.75)		(1.40)	(1.02)	(10.16)
243 Winchester Super Short Magnum	.535	.054	.480	.200	.5558	.5469	1.2403	1.2503	28°	0.8000	45°	.040	.060	.445
	(13.59)	(1.37)	(12.19)	(5.08)	(14.117)	(13.891)	(31.504)	(31.758)		(20.320)		(1.02)	(1.52)	(11.30)
25 Winchester Super Short Magnum	.535	.054	.480	.200	.5558	.5469	1.2403	1.2503	30°	0.8000	45°	.040	.060	.445
	(13.59)	(1.37)	(12.19)	(5.08)	(14.117)	(13.891)	(31.504)	(31.758)		(20.320)		(1.02)	(1.52)	(11.30)
25-06 Remington	.473	.049	.409	.200	.4703	.4435	2.0487	2.0587	17°15'	1.6500	36°	.033	.060	.375
	(12.01)	(1.24)	(10.39)	(5.08)	(11.946)	(11.265)	(52.037)	(52.291)		(41.910)		(0.84)	(1.52)	(9.53)
250 Savage	.473	.049	.409	.200	.4692	.4197	1.5792	1.5892	26°30'	1.2000	36°	.033	.110	.347
	(12.01)	(1.24)	(10.39)	(5.08)	(11.918)	(10.660)	(40.112)	(40.366)		(30.480)		(0.84)	(2.79)	(8.81)
257 Roberts 257 Roberts +P	.473	.049	.409	.200	.4717	.4322	1.7937	1.8037	20°39'	1.4700	36°	.033	.040	.375
	(12.01)	(1.24)	(10.39)	(5.08)	(11.981)	(10.978)	(45.560)	(45.814)		(37.338)		(0.84)	(1.02)	(9.53)
26 Nosler	.534	.050	.475	.200	.5505	.5305	2.2390	2.2490	35°	1.7500	32°	.037	.040	.420
	(13.56)	(1.27)	(12.07)	(5.08)	(13.983)	(13.475)	(56.871)	(57.125)		(44.450)		(0.94)	(1.02)	(10.67)
260 Remington	.473	.054	.409	.200	.4709	.4559	1.6300	1.6400	20°	1.2500	36°	.055	.040	.400
	(12.01)	(1.37)	(10.39)	(5.08)	(11.961)	(11.580)	(41.402)	(41.656)		(31.750)		(1.40)	(1.02)	(10.16)
27 Nosler	.534	.050	.475	.200	.5505	.5305	2.1823	2.1923	35°	1.7500	32°	.037	.040	.420
	(13.56)	(1.27)	(12.07)	(5.08)	(13.983)	(13.475)	(55.430)	(55.684)		(44.450)		(0.94)	(1.02)	(10.67)
270 Winchester	.473	.049	.409	.200	.4703	.4435	2.0487	2.0587	17°15'	1.6500	36°	.033	.040	.375
	(12.01)	(1.24)	(10.39)	(5.08)	(11.946)	(11.265)	(52.037)	(52.291)		(41.910)		(0.84)	(1.02)	(9.53)
270 Winchester Short Magnum	.535	.054	.480	.200	.5558	.5408	1.7260	1.7360	35°	1.3000	45°	.040	.060	.445
	(13.59)	(1.37)	(12.19)	(5.08)	(14.117)	(13.736)	(43.840)	(44.094)		(33.020)		(1.02)	(1.52)	(11.30)
277 SIG Fury	.472	.054	.408	.200	.4709	.4629	1.6800	1.6870	30°	1.250	36°	.055	.040	.400
	(11.99)	(1.37)	(10.36)	(5.08)	(11.991)	(11.778)	(42.672)	(42.850)		(31.75)		(1.40)	(1.02)	(10.16)
28 Nosler	.534	.050	.475	.200	.5505	.5305	2.2390	2.2490	35°	1.7500	32°	.037	.040	.420
	(13.56)	(1.27)	(12.07)	(5.08)	(13.983)	(13.475)	(56.871)	(57.125)		(44.450)		(0.94)	(1.02)	(10.67)
280 Ackley Improved	.472	.047	.407	.200	.4705	.4557	2.1400	2.1500	40°	1.750	36°	.027	.035	.375
	(11.99)	(1.19)	(10.34)	(5.08)	(11.951)	(11.575)	(54.356)	(54.610)		(44.45)		(0.69)	(0.89)	(9.53)
280 Remington	.473	.049	.409	.200	.4709	.4422	2.1000	2.1100	17°15'	1.7500	36°	.033	.035	.375
	(12.01)	(1.24)	(10.39)	(5.08)	(11.991)	(11.232)	(53.340)	(53.594)		(44.450)		(0.84)	(0.89)	(9.53)
284 Winchester	.473	.054	.409	.200	.5005	.4781	1.8100	1.8200	35°	1.4000	40°	.040	.040	.420
	(12.01)	(1.37)	(10.39)	(5.08)	(12.713)	(12.144)	(45.974)	(46.228)		(35.560)		(1.02)	(1.02)	(10.67)
30 Nosler	.534	.050	.475	.200	.5505	.5305	2.1880	2.1980	35°	1.7500	32°	.037	.040	.420
	(13.56)	(1.27)	(12.07)	(5.08)	(13.983)	(13.475)	(55.575)	(55.829)		(44.450)		(0.94)	(1.02)	(10.67)
30 Remington AR	.492	.054	.428	.200	.5005	.4912	1.1590	1.1690	25°	0.700	36°	.055	.040	.400
	(12.50)	(1.37)	(10.87)	(5.08)	(12.713)	(12.476)	(29.439)	(29.693)		(17.78)		(1.40)	(1.02)	(10.16)
30 Thompson Center	.473	.054	.409	.200	.4721	.4655	1.5640	1.5740	30°	1.1500	36°	.055	.040	.400
	(12.01)	(1.37)	(10.39)	(5.08)	(11.991)	(11.824)	(39.726)	(39.980)		(29.210)		(1.40)	(1.02)	(10.16)
30-06 Springfield	.473	.049	.409	.200	.4703	.4435	2.0487	2.0587	17°15'	1.6500	36°	.033	.060	.375
	(12.01)	(1.24)	(10.39)	(5.08)	(11.946)	(11.265)	(52.037)	(52.291)		(41.910)		(0.84)	(1.52)	(9.53)
300 AAC Blackout	.378	.045	.332	.200	.3764	.3625	1.0789	1.0889	23°	0.8000	25°	.030	.035	.351
	(9.60)	(1.14)	(8.43)	(5.08)	(9.561)	(9.208)	(27.404)	(27.658)		(20.320)		(0.76)	(0.89)	(8.92)
300 HAM'R	.378	.045	.332	.200	.3763	.3677	1.3497	1.3597	30°	1.0000	25°	.030	.025	.3512
	(9.60)	(1.14)	(8.43)	(5.08)	(9.558)	(9.340)	(31.742)	(34.282)		(25.400)		(0.76)	(0.64)	(8.920)

I. GAUGES FOR SHOULDER-BREECHING CARTRIDGES (Cont'd)

CARTRIDGE NAME	A	B	C	BASIC D	E1	E2	F		G	BASIC			K	L	BASIC M
							MIN	MAX		H	J				
300 Norma Magnum (METRIC ORIGIN) ¹⁶	.588	.060	.521	.200	.5867	.5642	2.0360	2.0460	20° 30'	1.6500	50°	.037	.040	.455	
	(14.94)	(1.52)	(13.23)	(5.08)	(14.902)	(14.331)	(51.714)	(51.968)		(41.910)		(0.94)	(1.02)	(11.56)	
300 Precision Rifle Cartridge	.532	.050	.475	.200	.5325	.5170	2.2000	2.2100	30°	1.7500	35°	.037	.040	.420	
	(13.51)	(1.27)	(12.07)	(5.08)	(13.526)	(13.132)	(55.880)	(56.134)		(44.450)		(0.94)	(1.02)	(10.67)	
300 Remington Short Action Ultra Magnum	.534	.050	.475	.200	.5505	.5362	1.5990	1.6090	30°	1.2500	32°	.037	.040	.460	
	(13.56)	(1.27)	(12.07)	(5.08)	(13.983)	(13.619)	(40.615)	(40.869)		(31.750)		(0.94)	(1.02)	(11.68)	
300 Remington Ultra Magnum	.534	.050	.475	.200	.5505	.5305	2.4742	2.4842	30°	1.7500	32°	.037	.040	.420	
	(13.56)	(1.27)	(12.07)	(5.08)	(13.983)	(13.475)	(62.845)	(63.099)		(44.450)		(0.94)	(1.02)	(10.67)	
300 Ruger Compact Magnum	.532	.050	.475	.200	.5325	.5171	1.7217	1.7317	30°	1.300	35°	.037	.040	.420	
	(13.51)	(1.27)	(12.07)	(5.08)	(13.526)	(13.134)	(43.731)	(43.985)		(33.02)		(0.94)	(1.02)	(10.67)	
300 Savage	.473	.049	.409	.200	.4712	.4487	1.6017	1.6117	30°	1.2500	36°	.033	.040	.3968	
	(12.01)	(1.24)	(10.39)	(5.08)	(11.968)	(11.397)	(40.683)	(40.937)		(31.750)		(0.84)	(1.02)	(10.079)	
300 Winchester Short Magnum	.535	.054	.480	.200	.5558	.5408	1.7260	1.7360	35°	1.3000	45°	.040	.060	.445	
	(13.59)	(1.37)	(12.19)	(5.08)	(14.117)	(13.736)	(43.840)	(44.094)		(33.020)		(1.02)	(1.52)	(11.30)	
308 Marlin Express	.506	.063	.410	.200	.4709	.4561	1.5377	1.5477	20°	1.150	25°	.018	.040	.400	
	(12.85)	(1.60)	(10.41)	(5.08)	(11.961)	(11.585)	(39.058)	(39.312)		(29.210)		(0.46)	(1.02)	(10.16)	
308 Winchester	.473	.054	.409	.200	.4709	.4559	1.6300	1.6400	20°	1.2500	36°	.055	.040	.400	
	(12.01)	(1.37)	(10.39)	(5.08)	(11.961)	(11.580)	(41.402)	(41.656)		(31.750)		(1.40)	(1.02)	(10.16)	
325 Winchester Short Magnum	.535	.054	.480	.200	.5558	.5408	1.7260	1.7360	35°	1.3000	45°	.040	.060	.445	
	(13.59)	(1.37)	(12.19)	(5.08)	(14.117)	(13.736)	(43.840)	(44.094)		(33.020)		(1.02)	(1.52)	(11.30)	
33 Nosler	.534	.050	.475	.200	.5505	.5305	2.0760	2.0860	35°	1.7500	32°	.037	.040	.440	
	(13.56)	(1.27)	(12.07)	(5.08)	(13.983)	(13.475)	(52.730)	(52.984)		(44.450)		(0.94)	(1.02)	(11.18)	
338 Federal	.473	.054	.409	.200	.4709	.4559	1.6025	1.6125	20°	1.250	36°	.055	.040	.420	
	(12.01)	(1.37)	(10.39)	(5.08)	(11.991)	(11.580)	(40.704)	(40.958)		(31.750)		(1.40)	(1.02)	(10.67)	
338 Lapua Magnum (METRIC ORIGIN)	.588	.060	.521	.200	.5868	.5460	2.2750	2.2850	20°	1.900	50° 04'	.035	.108	.460	
	(14.94)	(1.52)	(13.23)	(5.08)	(14.905)	(13.868)	(57.785)	(58.039)		(48.26)	48"	(0.89)	(2.74)	(11.68)	
338 Marlin Express	.553	.050	.441	.200	.5068	.4948	1.5351	1.5451	25°	1.150	36°	.039	.040	.420	
	(14.05)	(1.27)	(11.20)	(5.08)	(12.873)	(12.568)	(38.992)	(39.246)		(29.21)		(0.99)	(1.02)	(10.67)	
338 Norma Magnum (METRIC ORIGIN)	.588	.060	.521	.200	.5872	.5771	2.0101	2.0201	20°	1.600	50°	.037	.040	.475	
	(14.94)	(1.52)	(13.23)	(5.08)	(14.915)	(14.658)	(51.057)	(51.311)		(40.640)		(0.94)	(1.02)	(12.07)	
338 Remington Ultra Magnum	.534	.050	.475	.200	.5505	.5305	2.3490	2.3590	30°	1.750	32°	.037	.040	.460	
	(13.56)	(1.27)	(12.07)	(5.08)	(13.983)	(13.475)	(59.665)	(59.919)		(44.450)		(0.94)	(1.02)	(11.68)	
338 Ruger Compact Magnum	.532	.050	.475	.200	.5325	.5175	1.6227	1.6327	30°	1.265	35°	.037	.040	.450	
	(13.51)	(1.27)	(12.07)	(5.08)	(13.526)	(13.145)	(41.217)	(41.471)		(32.13)		(0.94)	(1.02)	(11.43)	
338 Weatherby Rebased Precision Magnum	.473	.054	.409	.200	.5005	.4785	2.1940	2.2040	35°	1.650	40°	.040	.040	.420	
	(12.01)	(1.37)	(10.39)	(5.08)	(12.713)	(12.154)	(55.728)	(55.982)		(41.91)		(1.02)	(1.02)	(10.67)	
35 Remington	.460	.050	.400	.200	.4584	.4292	1.5581	1.5681	23°25'	1.2400	34°	.030	.035	.4050	
	(11.68)	(1.27)	(10.16)	(5.08)	(11.643)	(10.902)	(39.576)	(39.830)		(31.496)		(0.76)	(0.89)	(10.287)	
35 Whelen	.473	.049	.409	.200	.4703	.4435	1.9835	1.9935	17°30'	1.6500	36°	.033	.060	.4150	
	(12.01)	(1.24)	(10.39)	(5.08)	(11.946)	(11.265)	(50.381)	(50.635)		(41.910)		(0.84)	(1.52)	(10.541)	
358 Winchester	.473	.054	.409	.200	.4709	.4559	1.6025	1.6125	20°	1.2500	36	.055	.040	0.420	
	(12.01)	(1.37)	(10.39)	(5.08)	(11.961)	(11.580)	(40.704)	(40.958)		(31.750)		(1.40)	(1.02)	(10.67)	
370 Sako Magnum (METRIC ORIGIN) ¹⁷	.470	.051	.413	.200	.4781	.4548	2.2450	2.2550	17°32'33"	1.7500	41°	.039	.020	.420	
	(11.95)	(1.30)	(10.50)	(5.08)	(12.144)	(11.552)	(57.023)	(57.277)		(44.450)		(1.00)	(0.50)	(10.67)	
375 Remington Ultra Magnum	.534	.050	.475	.200	.5505	.5305	2.4352	2.4452	30°	1.7500	32°	.037	.040	.465	
	(13.56)	(1.27)	(12.07)	(5.08)	(13.983)	(13.475)	(61.854)	(62.108)		(44.450)		(0.94)	(1.02)	(11.81)	
375 Ruger	.532	.050	.475	.200	.5325	.5175	2.2191	2.2291	30°	1.750	35°	.037	.040	.465	
	(13.51)	(1.27)	(12.07)	(5.08)	(13.526)	(13.145)	(56.365)	(56.619)		(44.45)		(0.94)	(1.02)	(11.81)	

¹⁶ This design was originally created using metric dimensions. The US Customary values are converted from the source metric and rounded.

¹⁷ This design was originally created using metric dimensions. The US Customary values are converted from the source metric and rounded.

I. GAUGES FOR SHOULDER-BREECHING CARTRIDGES (Cont'd)

CARTRIDGE NAME	A	B	C	BASIC D	E1	E2	F		BASIC			K	L	BASIC M
							MIN	MAX	G	H	J			
376 Steyr (METRIC ORIGIN)	.496	.051	.441	.200	.4781	.4548	1.9400	1.9500	17°29'30"	1.401	41°	.039	.030	.445
	(12.60)	(1.30)	(11.20)	(5.08)	(12.144)	(11.552)	(49.276)	(49.530)		(35.59)		(0.99)	(0.76)	(11.31)
416 Rigby	.590	.065	.500	.500	.5819	.5483	2.3738	2.3838	44°45'30"	1.5000	45°	.031	.069	.496
	(14.99)	(1.65)	(12.70)	(12.70)	(14.780)	(13.927)	(60.295)	(60.549)		(38.100)		(0.79)	(1.75)	(12.60)
416 Ruger	.532	.050	.475	.200	.5325	.5175	2.1974	2.2074	30.00	1.750	35°	.037	.040	.490
	(13.51)	(1.27)	(12.07)	(5.08)	(13.526)	(13.145)	(55.814)	(56.068)		(44.450)		(0.94)	(1.02)	(12.45)

II. GAUGES FOR BELT-BREACHING CARTRIDGES

FIGURE II
 BELT-BREACHING CENTERFIRE RIFLE HEADSPACE GAUGES

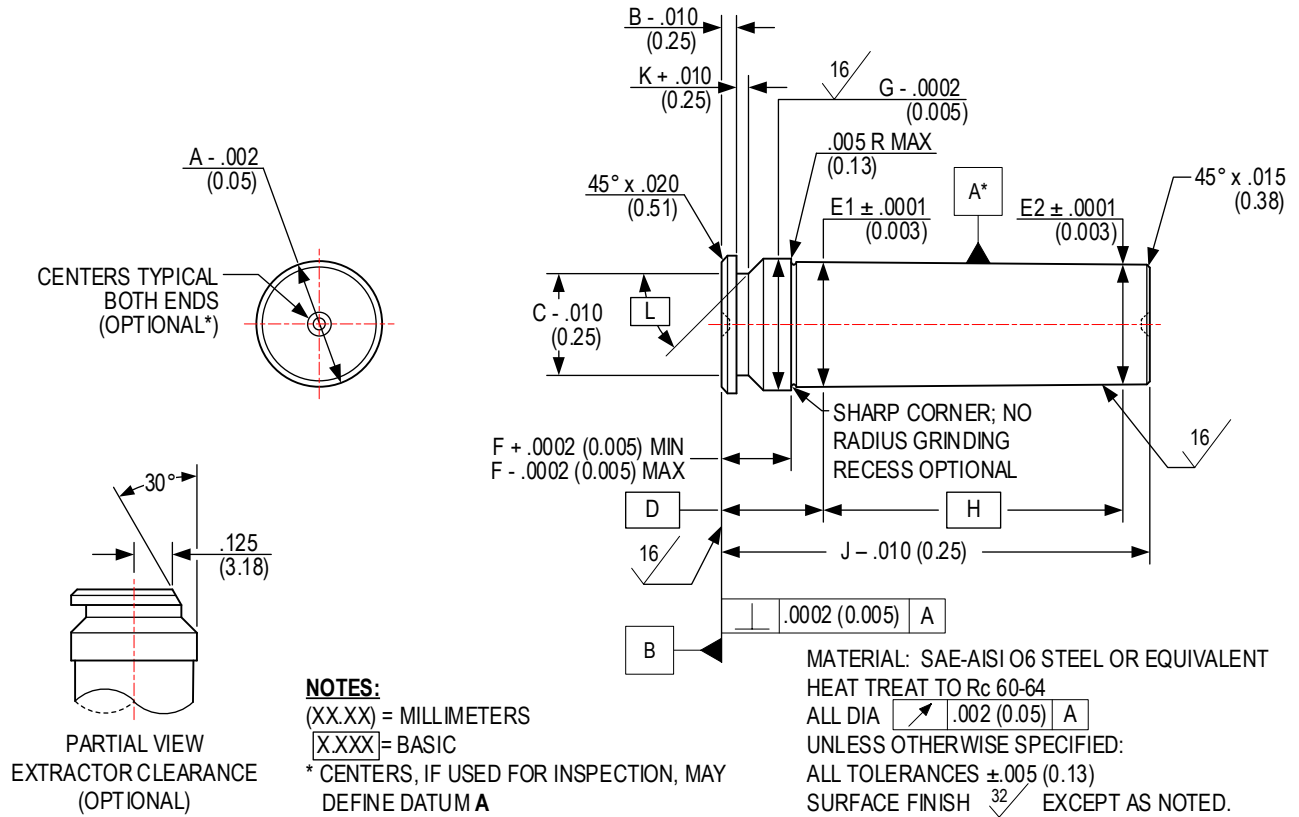

CARTRIDGE NAME	A	B	C	BASIC D	E1	E2	F		G	BASIC H	J	K	BASIC L
							MIN	MAX					
6.5-300 Weatherby Magnum	.5315 (13.500)	.051 (1.30)	.457 (11.61)	.250 (6.35)	.5132 (13.025)	.4981 (12.652)	.220 (5.59)	.227 (5.77)	.533 (13.54)	1.750 (44.45)	2.040 (51.82)	.049 (1.24)	45°
7mm Remington Magnum	.532 (13.51)	.050 (1.27)	.475 (12.07)	.250 (6.35)	.5131 (13.033)	.4923 (12.504)	.220 (5.59)	.227 (5.77)	.533 (13.54)	1.720 (43.69)	2.010 (51.05)	.037 (0.94)	35°
7mm Weatherby Magnum	.5315 (13.500)	.051 (1.30)	.457 (11.61)	.250 (6.35)	.5132 (13.035)	.4957 (12.591)	.220 (5.59)	.224 (5.69)	.532 (13.51)	1.750 (44.45)	2.014 (51.16)	.049 (1.24)	45°
257 Weatherby Magnum	.531 (13.49)	.051 (1.30)	.457 (11.61)	.250 (6.35)	.5132 (13.035)	.4957 (12.591)	.220 (5.59)	.224 (5.69)	.532 (13.51)	1.750 (44.45)	2.014 (51.16)	.049 (1.24)	45°
264 Winchester Magnum	.532 (13.51)	.050 (1.27)	.475 (12.07)	.250 (6.35)	.5131 (13.033)	.4927 (12.515)	.220 (5.59)	.227 (5.77)	.533 (13.54)	1.700 (43.18)	1.990 (50.55)	.037 (0.94)	35°
270 Weatherby Magnum	.5315 (13.500)	.051 (1.30)	.457 (11.61)	.250 (6.35)	.5132 (13.035)	.4957 (12.591)	.220 (5.59)	.224 (5.69)	.532 (13.51)	1.750 (44.45)	2.014 (51.16)	.049 (1.24)	45°
300 H&H Magnum	.532 (13.51)	.050 (1.27)	.475 (12.07)	.250 (6.35)	.5125 (13.018)	.4565 (11.595)	.220 (5.59)	.227 (5.77)	.533 (13.54)	1.650 (41.91)	1.940 (49.28)	.037 (0.94)	35°
300 Weatherby Magnum	.5315 (13.500)	.051 (1.30)	.457 (11.61)	.250 (6.35)	.5132 (13.035)	.4981 (12.652)	.220 (5.59)	.224 (5.69)	.532 (13.51)	1.750 (44.45)	2.040 (51.82)	.049 (1.24)	45°
300 Winchester Magnum	.532 (13.51)	.050 (1.27)	.475 (12.07)	.250 (6.35)	.5131 (13.033)	.4920 (12.497)	.220 (5.59)	.227 (5.77)	.533 (13.54)	1.750 (44.45)	2.040 (51.82)	.037 (0.94)	35°
338 Winchester Magnum	.532 (13.51)	.050 (1.27)	.475 (12.07)	.250 (6.35)	.5131 (13.033)	.4930 (12.374)	.220 (5.59)	.227 (5.77)	.533 (13.54)	1.670 (42.42)	1.960 (49.78)	.037 (0.94)	35°
340 Weatherby Magnum	.5315 (13.500)	.051 (1.30)	.457 (11.61)	.250 (6.35)	.5132 (13.035)	.4981 (12.652)	.220 (5.59)	.224 (5.69)	.532 (13.51)	1.750 (44.45)	2.040 (51.82)	.049 (1.24)	45°

II. GAUGES FOR BELT-BREECHING CARTRIDGES (Cont'd)

CARTRIDGE NAME	A	B	C	BASIC D	E1	E2	F		G	BASIC H	J	K	BASIC L
							MIN	MAX					
375 H&H Magnum	.532	.050	.475	.250	.5126	.4635	.220	.227	.533	1.650	1.940	.037	35°
	(13.51)	(1.27)	(12.07)	(6.35)	(13.020)	(11.773)	(5.59)	(5.77)	(13.54)	(41.91)	(49.28)	(0.94)	
416 Remington Magnum	.532	.050	.475	.250	.5131	.4921	.220	.227	.533	1.750	2.040	.037	35°
	(13.51)	(1.27)	(12.07)	(6.35)	(13.033)	(12.499)	(5.59)	(5.77)	(13.54)	(44.45)	(51.82)	(0.94)	
416 Weatherby Magnum	.579	.063	.495	.280	.5832	.5666	.253	.257	.604	1.750	2.070	0.049	45°
	(14.71)	(1.60)	(12.57)	(7.11)	(14.813)	(14.392)	(6.43)	(6.53)	(15.34)	(44.45)	(52.58)	(1.24)	
450 Marlin	.532	.050	.475	.280	.5136	.4842	.252	.259	.533	1.720	2.040	.037	35°
	(13.51)	(1.27)	(12.07)	(7.11)	(13.045)	(12.299)	(6.40)	(6.58)	(13.54)	(43.69)	(51.82)	(0.94)	
458 Lott	.532	.050	.475	.250	.5131	.4850	.220	.227	.532	2.350	2.640	.037	35°
	(13.51)	(1.27)	(12.07)	(6.35)	(13.033)	(12.319)	(5.59)	(5.77)	(13.51)	(59.69)	(67.06)	(0.94)	
458 Winchester Magnum	.532	.050	.475	.250	.5141	.4842	.220	.227	.533	2.150	2.440	.037	35°
	(13.51)	(1.27)	(12.07)	(6.35)	(13.058)	(12.299)	(5.59)	(5.77)	(13.54)	(54.61)	(61.98)	(0.94)	

III. GAUGES FOR RIM-BREECHING CARTRIDGES

**FIGURE III
 RIM-BREECHING CENTERFIRE RIFLE HEADSPACE GAUGES**

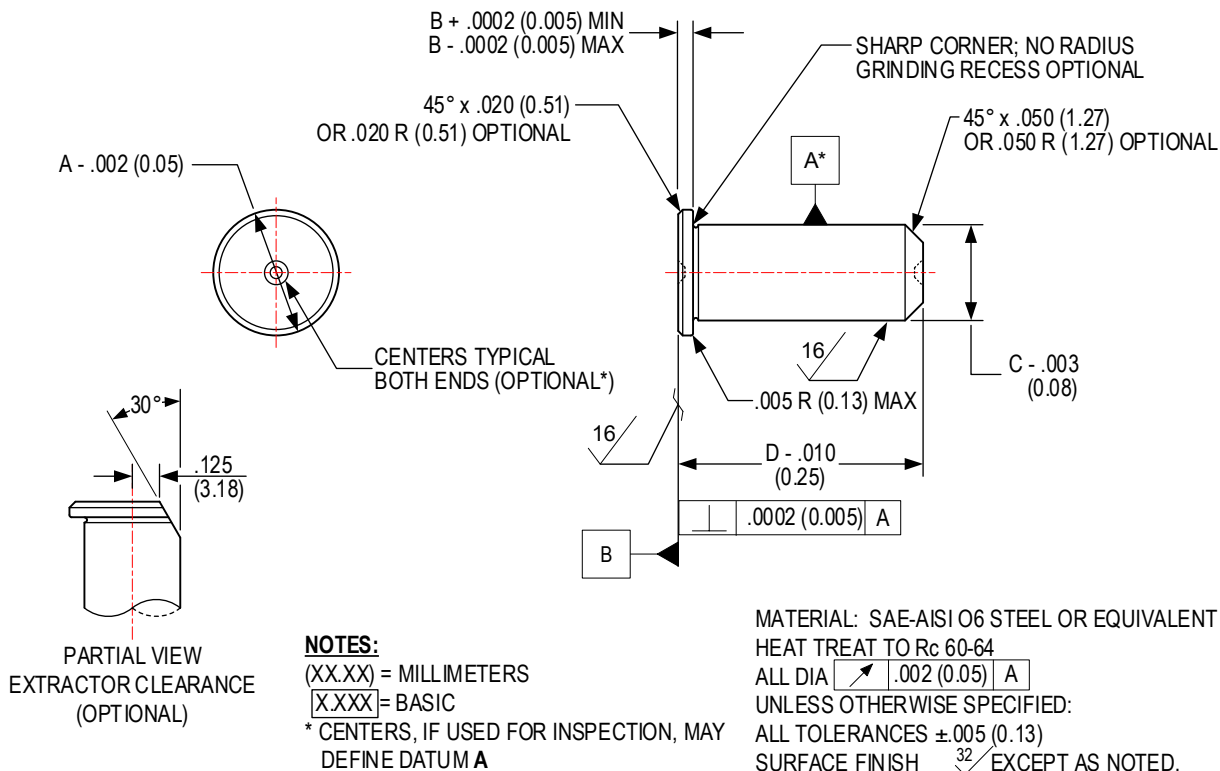

CARTRIDGE NAME	A	B		C	D
		MIN	MAX		
17 Hornet	.350	.0650	.0720	.294	1.036
	(8.89)	(1.651)	(1.829)	(7.47)	(26.31)
218 Bee	.408	.0650	.0720	.332	.921
	(10.36)	(1.651)	(1.829)	(8.43)	(23.39)
22 Hornet	.350	.0650	.0720	.277	.834
	(8.89)	(1.651)	(1.829)	(7.04)	(21.18)
25-20 Winchester	.408	.0650	.0720	.333	.848
	(10.36)	(1.651)	(1.829)	(8.46)	(21.54)
25-35 Winchester	.506	.0630	.0700	.363	1.375
	(12.85)	(1.600)	(1.778)	(9.22)	(34.93)
30-30 Winchester	.506	.0630	.0700	.402	1.444
	(12.85)	(1.600)	(1.778)	(10.21)	(36.68)
30-40 Krag	.545	.0640	.0710	.419	1.718
	(13.84)	(1.626)	(1.803)	(10.64)	(43.64)
303 British	.540	.0640	.0710	.402	1.802
	(13.72)	(1.626)	(1.803)	(10.21)	(45.77)
307 Winchester	.506	.0630	.0700	.454	1.552
	(12.85)	(1.600)	(1.778)	(11.53)	(39.42)
32 Winchester Special	.506	.0630	.0700	.402	1.439
	(12.85)	(1.600)	(1.778)	(10.21)	(36.55)
32-20 Winchester	.408	.0650	.0720	.342	.871
	(10.36)	(1.651)	(1.829)	(8.69)	(22.12)

III. GAUGES FOR RIM-BREECHING CARTRIDGES (Cont'd)

CARTRIDGE NAME	A	B		C	D
		MIN	MAX		
348 Winchester	.610	.0700	.0770	.484	1.650
	(15.49)	(1.778)	(1.956)	(12.29)	(41.91)
356 Winchester	.506	.0630	.0700	.454	1.552
	(12.85)	(1.600)	(1.778)	(11.53)	(39.42)
360 Buckhammer	.506	.0630	.0700	.380	1.795
	(12.85)	(1.600)	(1.778)	(9.65)	(45.59)
375 Winchester	.506	.0630	.0700	.400	1.790
	(12.85)	(1.600)	(1.778)	(10.16)	(45.47)
38-40 Winchester	.525	.0650	.0720	.455	.902
	(13.34)	(1.651)	(1.829)	(11.56)	(22.91)
38-55 Winchester	.506	.0630	.0700	.392	2.108
	(12.85)	(1.600)	(1.778)	(9.96)	(53.54)
405 Winchester	.543	.0730	.0800	.4350	2.573
	(13.79)	(1.854)	(2.032)	(11.)	(65.35)
44 Remington Magnum	.514	.0600	.0700	.457	1.298
	(13.06)	(1.524)	(1.778)	(11.56)	(32.97)
44-40 Winchester	.525	.0650	.0720	.457	.908
	(13.34)	(1.651)	(1.829)	(11.61)	(23.06)
444 Marlin	.514	.0630	.0700	.453	2.230
	(13.06)	(1.600)	(1.778)	(11.51)	(56.64)
45-70 Government	.608	.0700	.0770	.480	2.099
	(15.44)	(1.7780)	(1.9558)	(12.19)	(53.31)
470 Nitro Express	.6551	.0400	.0470	.530	2.391
	(16.640)	(1.016)	(1.194)	(13.46)	(60.73)
500 Nitro Express 3" (METRIC ORIGIN) ¹⁸	.6551	.0409	.0469	.532	3.000
	(16.640)	(1.040)	(1.190)	(13.51)	(76.20)

¹⁸ This design was originally created using metric dimensions. The US Customary values are converted from the source metric and rounded.

IV. GAUGES FOR MOUTH-BREACHING CARTRIDGES

**FIGURE IV
 MOUTH-BREACHING CENTERFIRE RIFLE HEADSPACE GAUGES**

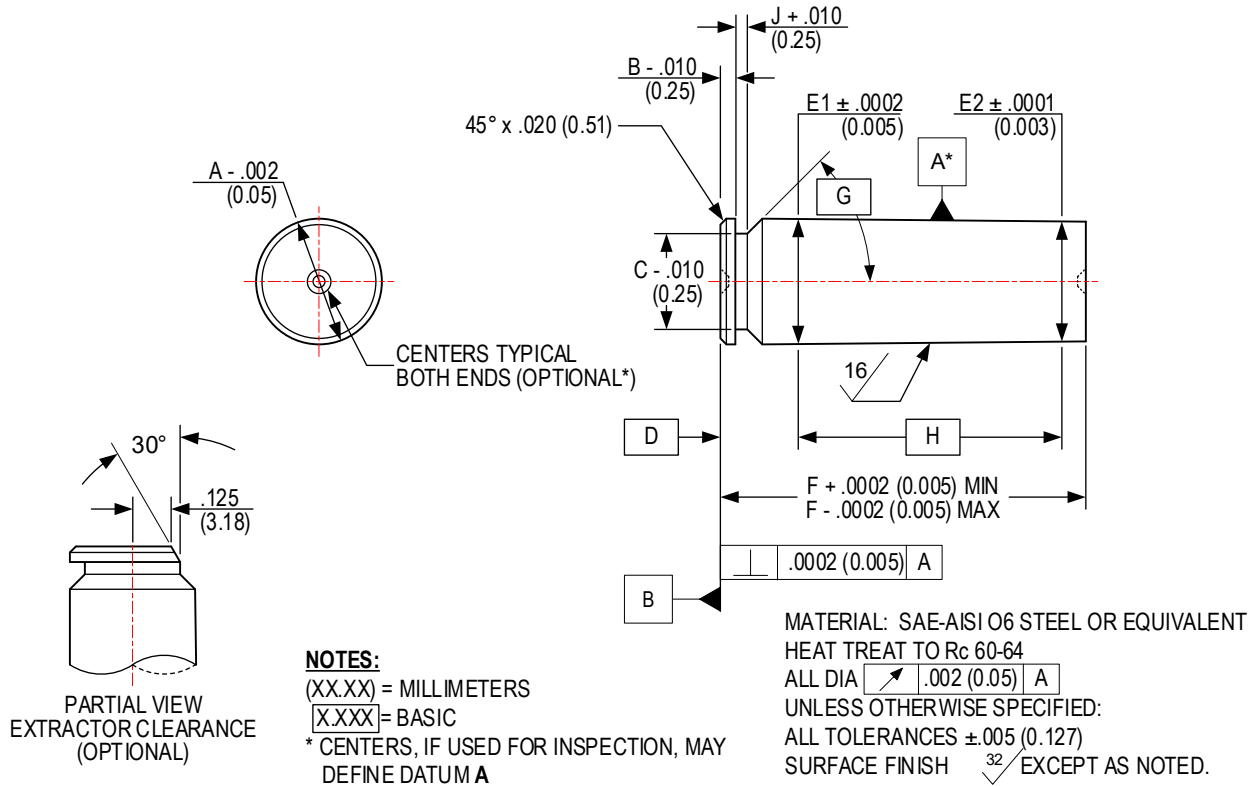

CARTRIDGE NAME	A	B	C	BASIC D	E1	E2	F		BASIC		J
							MIN	MAX	G	H	
30 Carbine	0.360	0.050	0.310	0.2000	0.3571	0.3454	1.2900	1.3000	32°	0.6700	0.033
	(9.14)	(1.27)	(7.87)	(5.080)	(9.070)	(8.773)	(32.766)	(33.020)		(17.018)	(0.838)
350 Legend	0.378	0.045	0.332	0.2000	0.3905	0.3797	1.7100	1.7200	25°	1.3500	0.030
	(9.60)	(1.14)	(8.43)	(5.080)	(9.919)	(9.644)	(43.434)	(43.688)		(34.290)	(0.76)
400 Legend	0.422	0.049	0.358	0.2000	0.4405	0.4281	1.6500	1.6600	36°	1.3500	0.033
	(10.72)	(1.24)	(9.09)	(5.080)	(11.189)	(10.874)	(41.910)	(42.164)		(34.290)	(0.84)
450 Bushmaster	0.473	0.054	0.409	0.2000	0.5005	0.4825	1.7000	1.7100	40°	1.3500	0.040
	(12.01)	(1.37)	(10.39)	(5.080)	(12.713)	(12.256)	(43.180)	(43.434)		(34.290)	(1.02)

V. GAUGES FOR SHOULDER-BREACHING CARTRIDGES WITHOUT AN INTEGRAL NECK

FIGURE V
SHOULDER-BREACHING CENTERFIRE
RIFLE HEADSPACE GAUGES
(CARTRIDGE DESIGNS WITH NO INTEGRAL NECK)

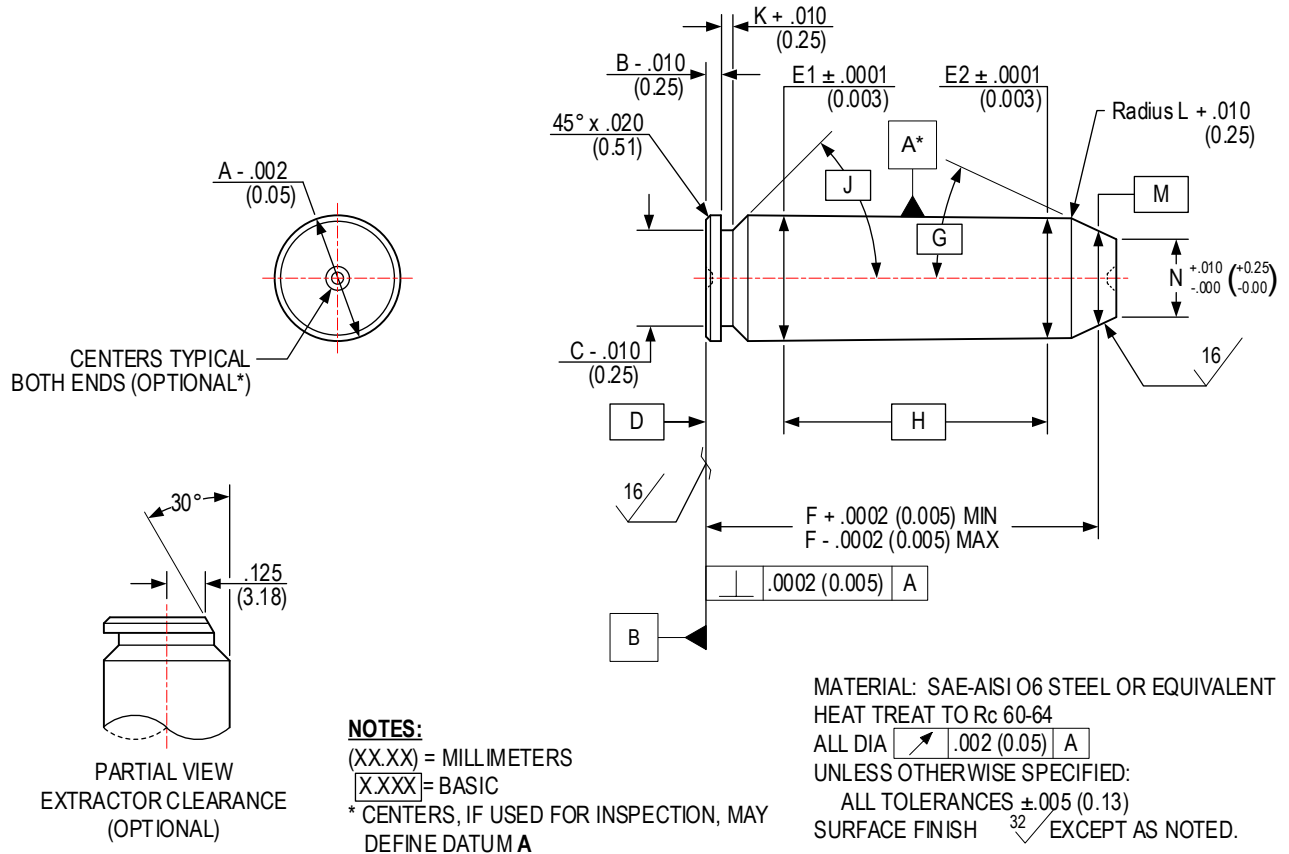

CARTRIDGE NAME	A	B	C	BASIC	E1	E2	F		BASIC			K	L	BASIC	N
				D			MIN	MAX	G	H	J			M	
6.8 True Velocity Composite	.472 (11.99)	.054 (1.37)	.409 (10.39)	.200 (5.08)	.4712 (11.968)	.4626 (11.750)	1.870 (47.50)	1.886 (47.90)	30°	1.500 (38.10)	36°	.055 (1.40)	.150 (3.81)	.392 (9.96)	.354 (9.00)

**EQUIPMENT:
REFERENCE AMMUNITION SUPPLY**

NOTE: Refer to Section III, page 233, *Supplier Contact Information*, for detailed information on contacting the manufacturers of listed products and the SAAMI Technical Office.

Centerfire rifle reference ammunition for the verification of ranges, test barrels, and other ballistic test equipment may be obtained from the manufacturer. Contact the SAAMI Technical Office or see the SAAMI website for detailed information.

The SAAMI Technical Office maintains current assessment data. SAAMI policy does not allow the release of assessment values by the manufacturer of reference ammunition. All assessments are to be supplied by the SAAMI Technical Office.

EQUIPMENT: REFERENCE AMMUNITION ORDER PROCEDURE

Each order should contain the following information, in the following order:

1. Number of rounds desired. (See NOTE, below.)
2. Appropriate order symbol, when given.
3. Designation “SAAMI Reference Ammunition”.
4. Cartridge name.
5. SAAMI lot number. (Current lot numbers are given on latest assessment value sheets issued by the SAAMI Technical Office.)

EXAMPLE:

100 rounds, Order symbol SA22H2
SAAMI Reference Ammunition
22 Hornet
SAAMI Lot 22HOR-46-11WW

NOTE: Recommended maximum order = 100 rounds. If an individual user has requirements for larger quantities, refer to Section II, page 191.

Manufacturers of SAAMI reference ammunition may limit the order quantities honored to the recommended maximum in order to prevent premature consumption of a lot.

It is up to the discretion of the manufacturer to produce lots of sufficient size to reasonably provide a five-year supply.

SUPPLIER CONTACT INFORMATION

Contact the SAAMI Technical Office using the information below or visit www.saami.org for a current list of supplier contact information.

SAAMI Technical Office *SAAMI Information*

6 Corporate Drive; Suite #650

Shelton, CT 06484

Phone: 203-426-4358

Website: www.saami.org

**EQUIPMENT:
 SCHEMATIC LAYOUT OF VELOCITY SCREENS**

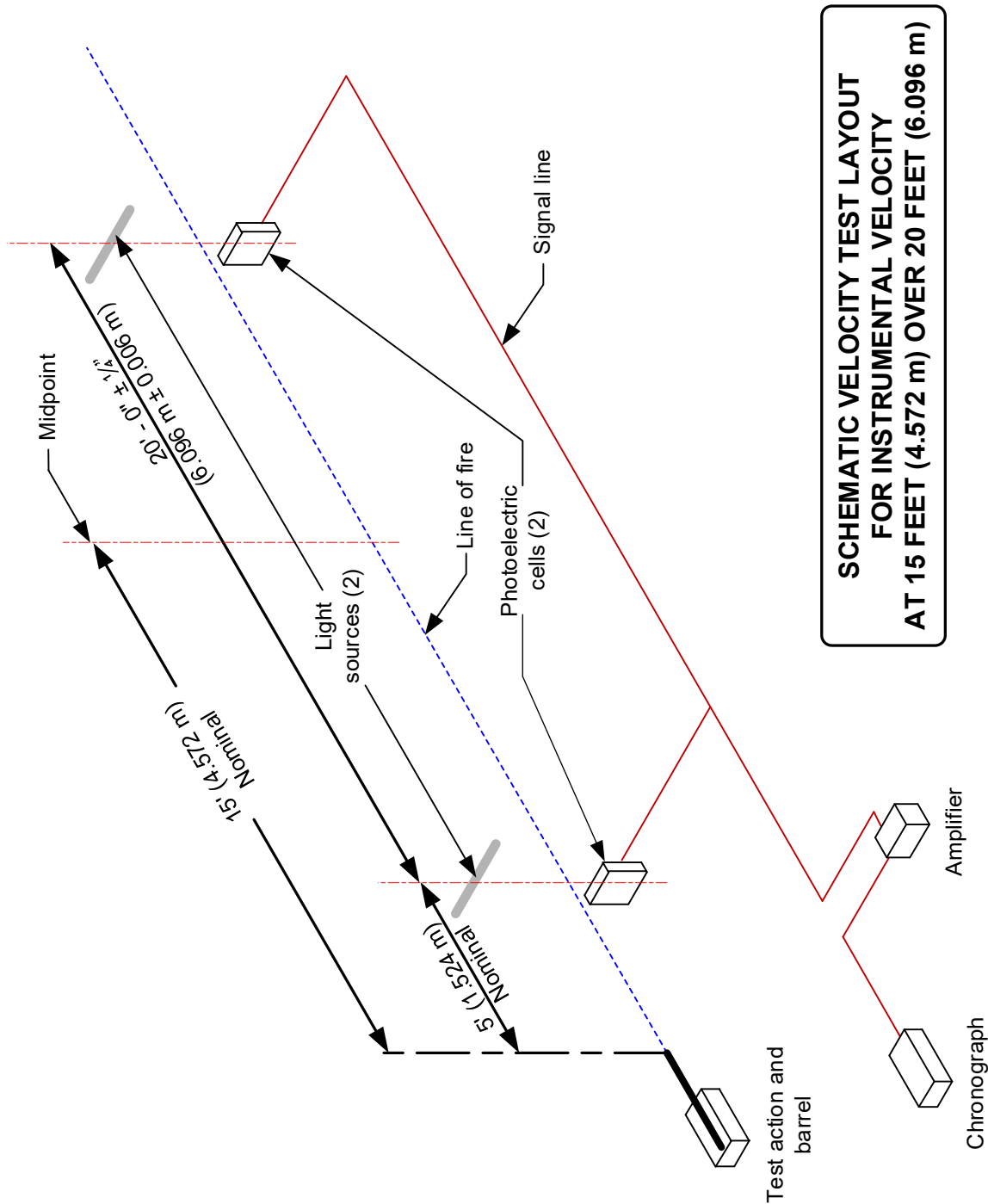

**EQUIPMENT:
UNIVERSAL RECEIVER COLLAR & TEST BARREL**

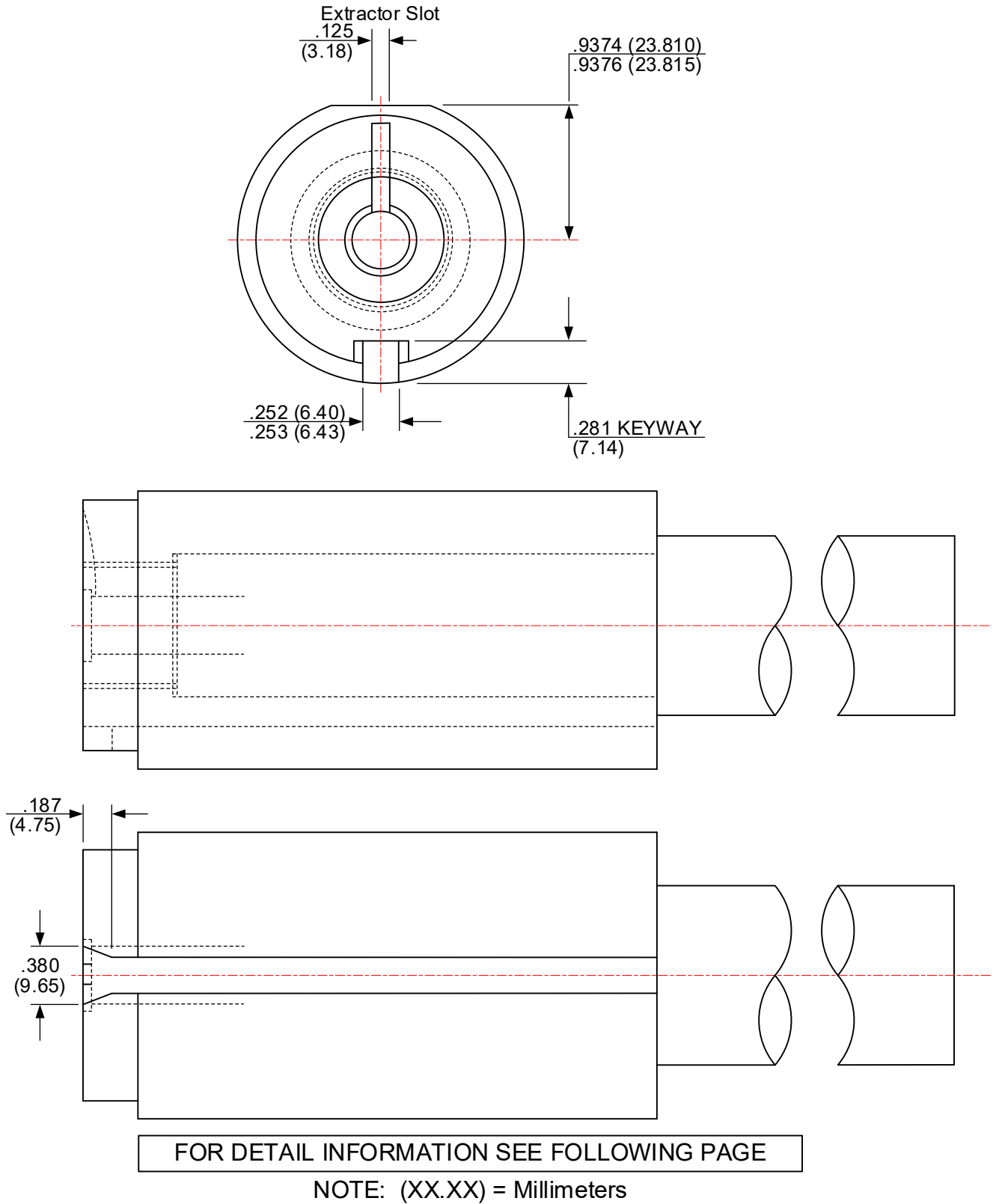

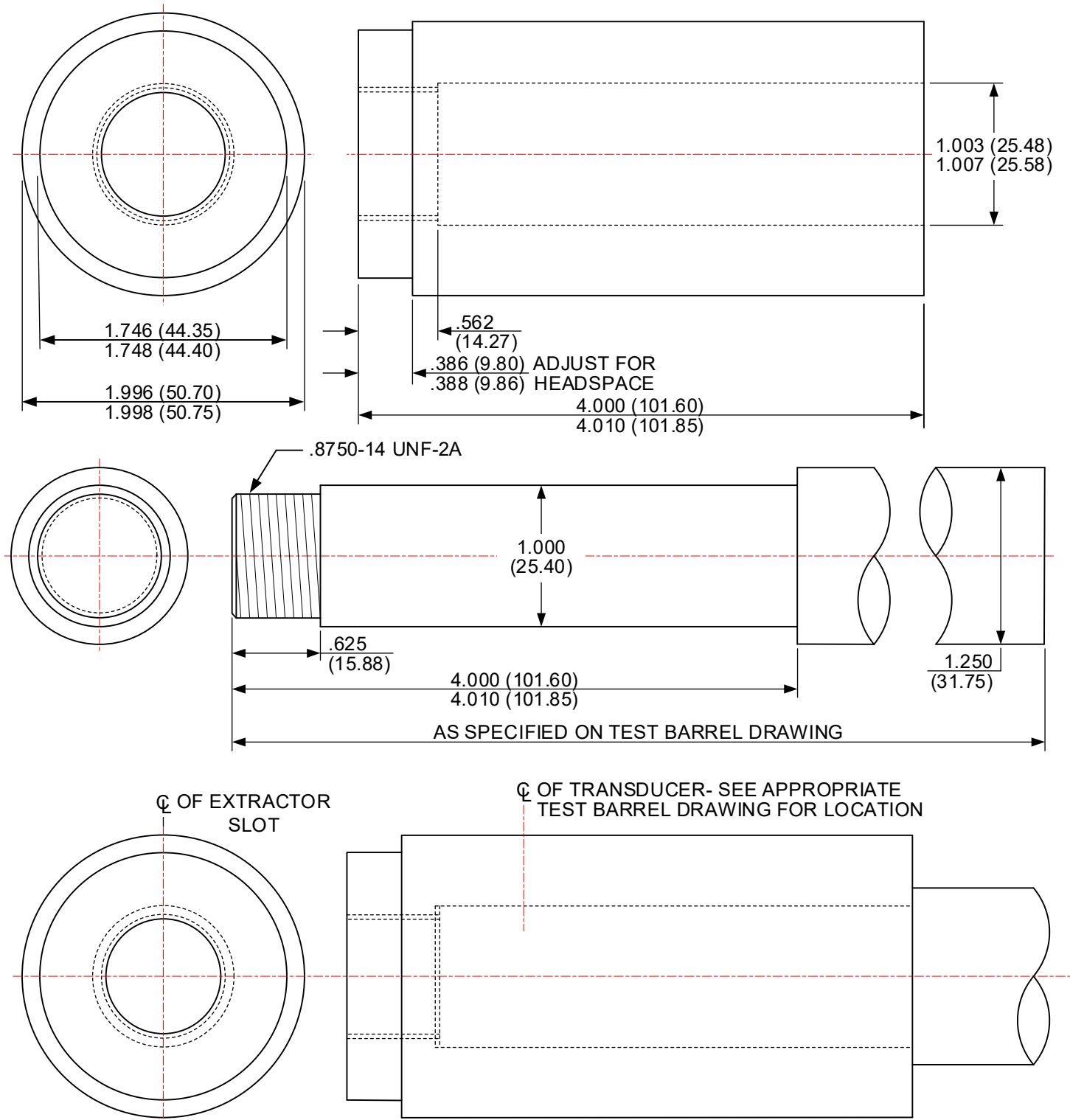

DRAW BARREL AND COLLAR TIGHT.
 TRANSDUCER HOLE AND HEAD CUTS
 MADE AFTER ASSEMBLY - SEE PAGES
 233 AND 235ff
 NOTE: (XX.XX) = MILLIMETERS

MATERIAL: RESULTURIZED SAE-AISI 4140 STEEL
 HEAT TREAT PRIOR TO MACHINING TO BRINELL
 HARDNESS 277 TO 321 (R_c 29 TO 35)
 ACCEPTABLE ALTERNATE: 416 STAINLESS STEEL

**UNIVERSAL RECEIVER TEST BARREL:
 INSTALLATION OF PRESSURE TRANSDUCERS**

1 - .250 (6.35) DIAMETER 3/8-INCH THREAD CONFORMAL PRESSURE GAUGES

UNLESS OTHERWISE NOTED
 US UNITS XXX ± .005
 METRIC UNITS XX ± 0.13

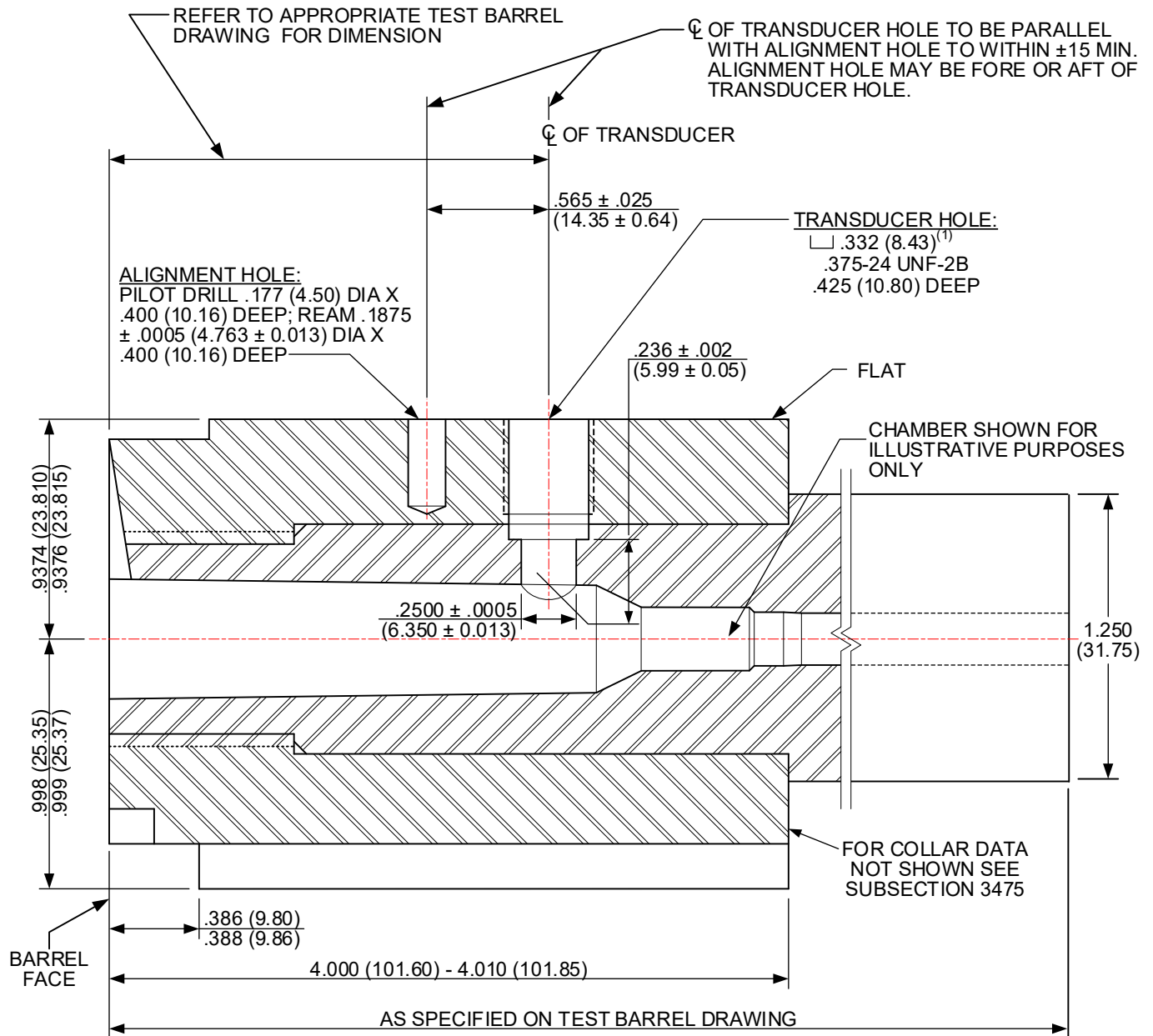

(1) – Depth of .332 (8.43) drill is dependent on the specific cartridge for which the test barrel is chambered.

NOTES

(XX.XX) = MILLIMETERS

TWO-PIECE BARREL SHOWN; MOUNTING DETAILS DO NOT CHANGE FOR ONE-PIECE BARRELS.

**UNIVERSAL RECEIVER TEST BARREL:
 INSTALLATION OF PRESSURE TRANSDUCERS (Cont'd)**

2 - .194 (4.93) DIAMETER – 5/16-INCH THREAD CONFORMAL PRESSURE GAUGES

UNLESS OTHERWISE NOTED
 US UNITS XXX ± .005
 METRIC UNITS XX ± 0.13

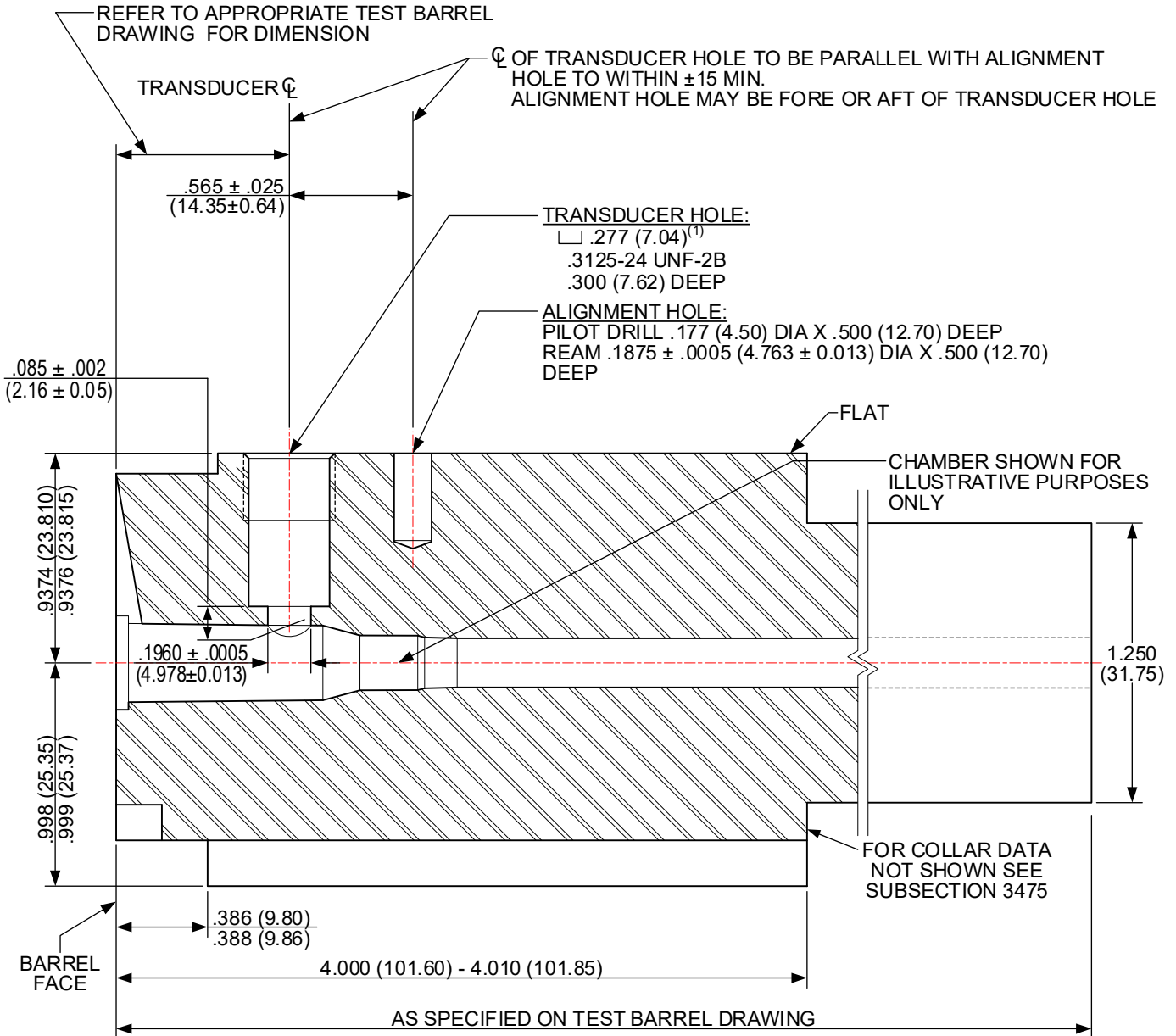

(1) – Depth of .277 (7.04) drill is dependent on the specific cartridge for which the test barrel is chambered.

NOTES

(XX.XX) = MILLIMETERS

ONE-PIECE TEST BARREL SHOWN; MOUNTING DETAILS DO NOT CHANGE FOR TWO-PIECE BARRELS.

**UNIVERSAL RECEIVER TEST BARREL:
 INSTALLATION OF PRESSURE TRANSDUCERS (Cont'd)**

3 - .250 (6.35) DIAMETER ½-INCH THREAD CONFORMAL PRESSURE GAUGES

UNLESS OTHERWISE NOTED
 US UNITS XXX ± .005
 METRIC UNITS XX ± 0.13

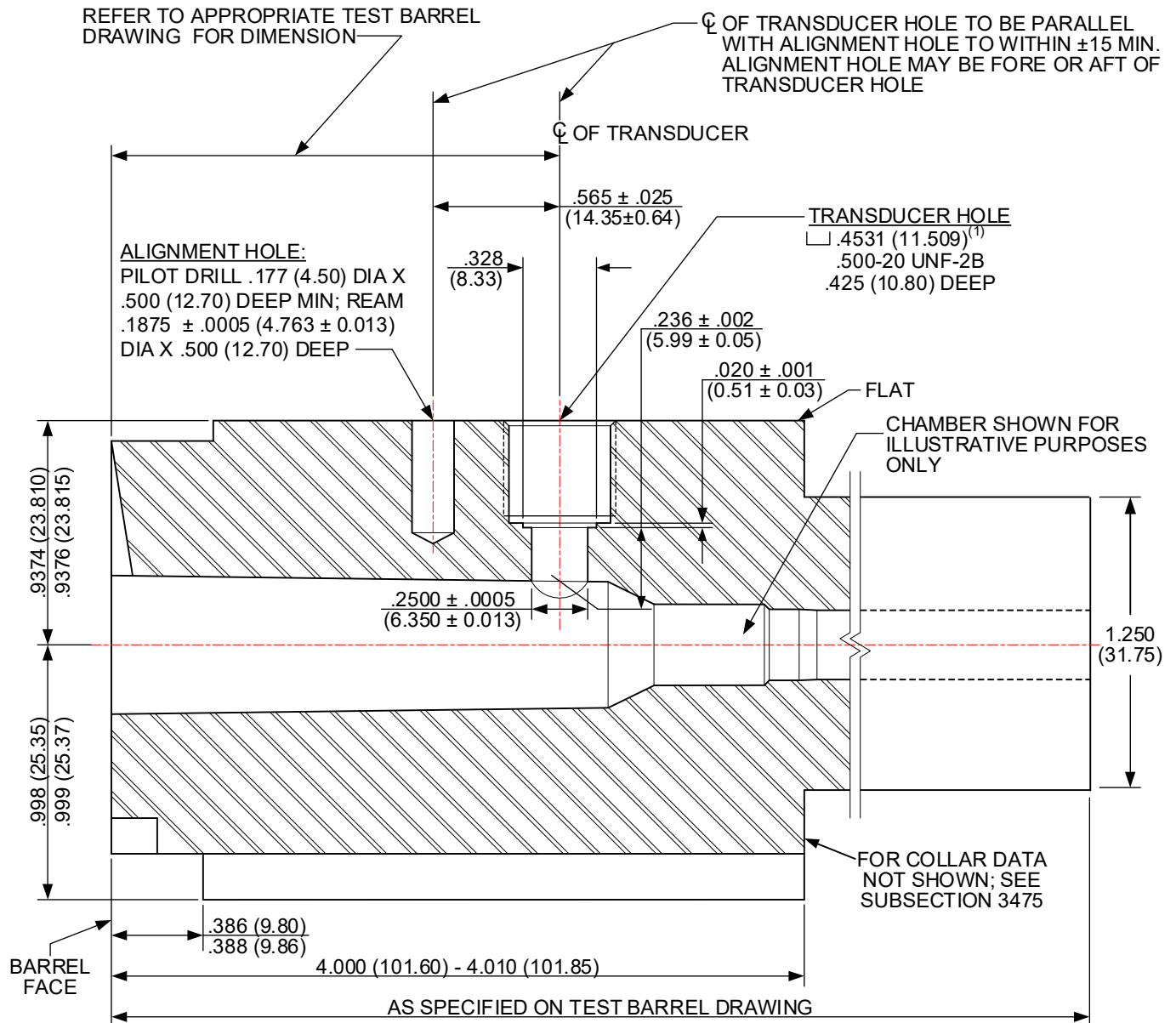

(1) – Depth of .4531 (11.509) drill is dependent on the specific cartridge for which the test barrel is chambered.

NOTES

(XX.XX) = MILLIMETERS

ONE-PIECE TEST BARREL SHOWN; MOUNTING DETAILS DO NOT CHANGE FOR TWO-PIECE BARRELS.

**EQUIPMENT:
TRANSDUCER CALIBRATION FIXTURE PLUG
WITH O-RING SEAL (OPTIONAL)***

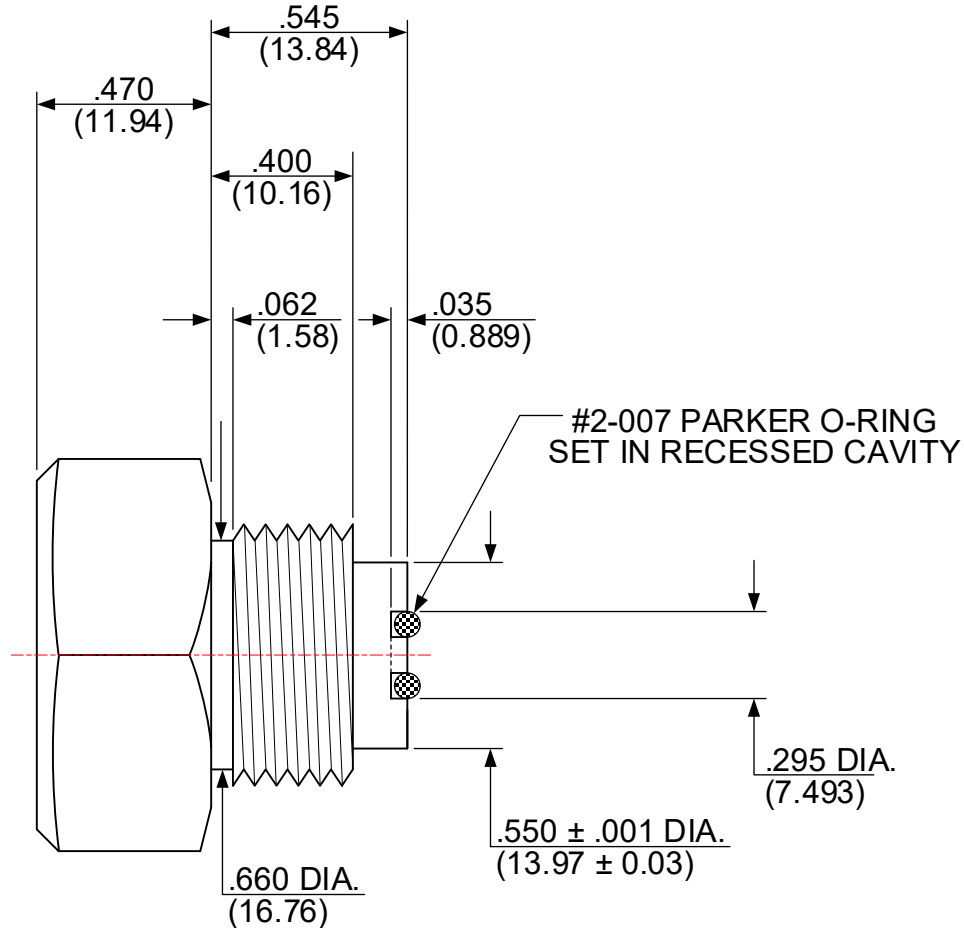

NOTES

MATERIAL: $\frac{3}{4}$ -16 UNF X $1\frac{1}{2}$ LONG R.H. (GRADE 8) STEEL HEX BOLT
ALL DIA. TO BE CONCENTRIC WITHIN $.001$ T.I.R.
UNLESS OTHERWISE NOTED ALL TOLERANCES ARE $\pm .005$ (.13)
* NOT TO EXCEED 65,000 PSI.

TRANSDUCER LOCATION AND SELECTION CRITERIA

I. Transducer Location

The following criteria for transducer location positioning should be followed when designing new cartridges. In those cases where following the criteria will cause the transducer to be located over current or projected bullet heel locations, case cannelures, or other undesirable areas, the best alternate location should be chosen. In general, the location should be as close to the bullet heel as practical.

A. Straight-walled Cartridge Cases

The centerline of the transducer shall be located behind the heel of the bullet by an amount equal to one-half the transducer diameter plus .005 - .010 (.13 - .25). This criterion applies to both .250 (6.35) sensor diameter and .194 (4.93) sensor diameter transducers.

B. Bottleneck Cartridge Cases

The centerline of the transducer shall be located behind the shell case shoulder intersection by an amount of .175 (4.44) for .250 (6.35) sensor diameter transducers and by .150 (3.80) for .194 (4.93) sensor diameter transducers.

II. Transducer Selection

The following is general guidance for the selection of transducers. The transducer manufacturer should be consulted before a final selection is made to ensure the transducer is appropriate for the application.

A. .194 (4.93) Sensor Diameter; 5/16" - 24 Thread Transducers

This transducer size is selected when the chamber diameter at transducer centerline is less than .350 (8.89) and the cartridge has an MAP less than or equal to 50,000 psi.

B. .250 (6.35) Sensor Diameter; 3/8" - 24 Thread Transducers

This transducer size is selected when the chamber diameter at transducer centerline is equal to or greater than .350 (8.89) and the cartridge has an MAP less than or equal to 65,000 psi.

C. .250 (6.35) Sensor Diameter; 1/2" - 20 Thread Transducers

This transducer size is selected when chamber diameter at transducer centerline is equal to or greater than .350 (8.89) and the cartridge has an MAP greater than 65,000 psi.

NOTE:

(XX.XX) = Millimeters

STANDARD V&P TEST BARRELS - GENERAL: PROCEDURES FOR DIMENSIONING CHAMBERS

Chamber and bore dimensions of velocity and pressure test barrels shall conform to the dimensions of the chamber and bore at Maximum Material Condition (MMC) for each cartridge as originally introduced. Fabrication tolerances, however, are much reduced.

It is recognized that changes may be made to cartridge or chamber dimensions in order to improve the velocity-pressure relationship, accuracy or functioning in rifles as production experience indicates. However, none of these changes should be of such nature that they would cause a significant increase in the pressure level of a given lot of ammunition.

No changes shall be made to velocity and pressure barrel dimensions which would result in a reduction of the recorded pressure level of any given lot of ammunition. This would result in the possibility of future lots of ammunition being loaded with increased powder charges, which would cause increased pressure in existing rifles.

Production barrels may be adapted for velocity and pressure testing provided that they conform to all dimensions shown on the appropriate test barrel drawing.

All standard test barrels shall be 24 inches long (610 mm). Exterior ballistic data for all centerfire rifle cartridges shall be based on this length.

Exceptions - Test barrel lengths for the following calibers are as shown:

- 7.62x39 20.000 inches (508.00 mm)
- 277 Sig Fury 16.000 inches (406.40 mm)
- 30 Carbine 20.000 inches (508.00 mm)
- 300 AAC Blackout 16.000 inches (406.40 mm)
- 300 HAM'R..... 16.000 inches (406.40 mm)
- 350 Legend 16.000 inches (406.40 mm)
- 350 Remington Magnum..... 20.000 inches (508.00 mm)
- 360 Buckhammer 20.000 inches (508.00 mm)
- 400 Legend 16.000 inches (406.40 mm)
- 44 Remington Magnum..... 20.000 inches (508.00 mm)

STANDARD V&P TEST BARRELS - GENERAL: PROCEDURES FOR MEASURING BARREL LENGTH

Centerfire rifle test barrels are measured by inserting a rod down the bore from the muzzle until it touches the breech face with the action closed and the firing pin retracted.

A stop collar or other means is utilized to mark the point on the rod adjacent to the most forward part of the barrel or the bottom of the counterbore in barrels having a counterbore recess at the muzzle.

The rod is removed and the distance from the mark to the end of the rod is measured. This measurement is recorded as the barrel length.

6MM ADVANCED RIFLE CARTRIDGE [6MM ARC]
 ISSUED: 01/20/2020 V&P TEST BARREL REVISED: 01/31/2022

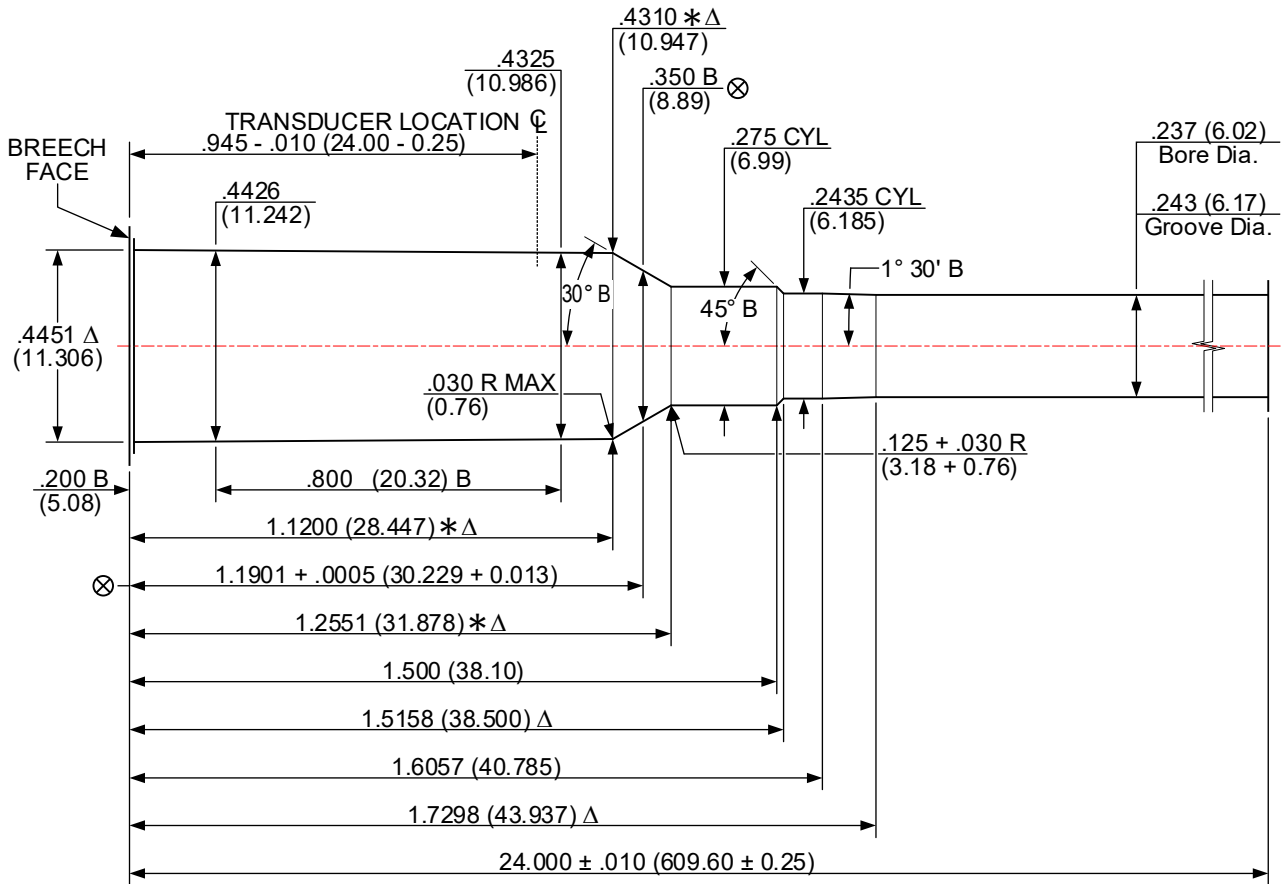

NUMBER OF GROOVES: 6
 WIDTH OF GROOVES: .090 + .002 (2.29 + 0.05)
 TWIST RATE: 7.50 (190.5) R.H.
 DIAMETER OF PISTON HOLE: Crusher pressures not established.
 TRANSDUCER DIAMETER: .250 (6.35)

LAND AND GROOVE DIMENSIONS TO BE
 WITHIN TOLERANCES THROUGHOUT
 LENGTH OF BARREL.

UNLESS OTHERWISE NOTED,
 ALL DIAMETERS +.0005 (0.013)
 LENGTH TOLERANCE + .005 (0.13)

DO NOT SCALE FROM DRAWING

NOTES:
 B = BASIC Δ = REFERENCE DIMENSION ⊗ = HEADSPACE DIMENSION
 * DIMENSIONS ARE TO INTERSECTIONS OF LINES (XX.XX) = MILLIMETERS
 ALL CALCULATIONS APPLY AT MAXIMUM MATERIAL CONDITION (MMC)

6MM CREEDMOOR [6MM CM]
 ISSUED: 06/14/2017 V&P TEST BARREL REVISED: 01/31/2022

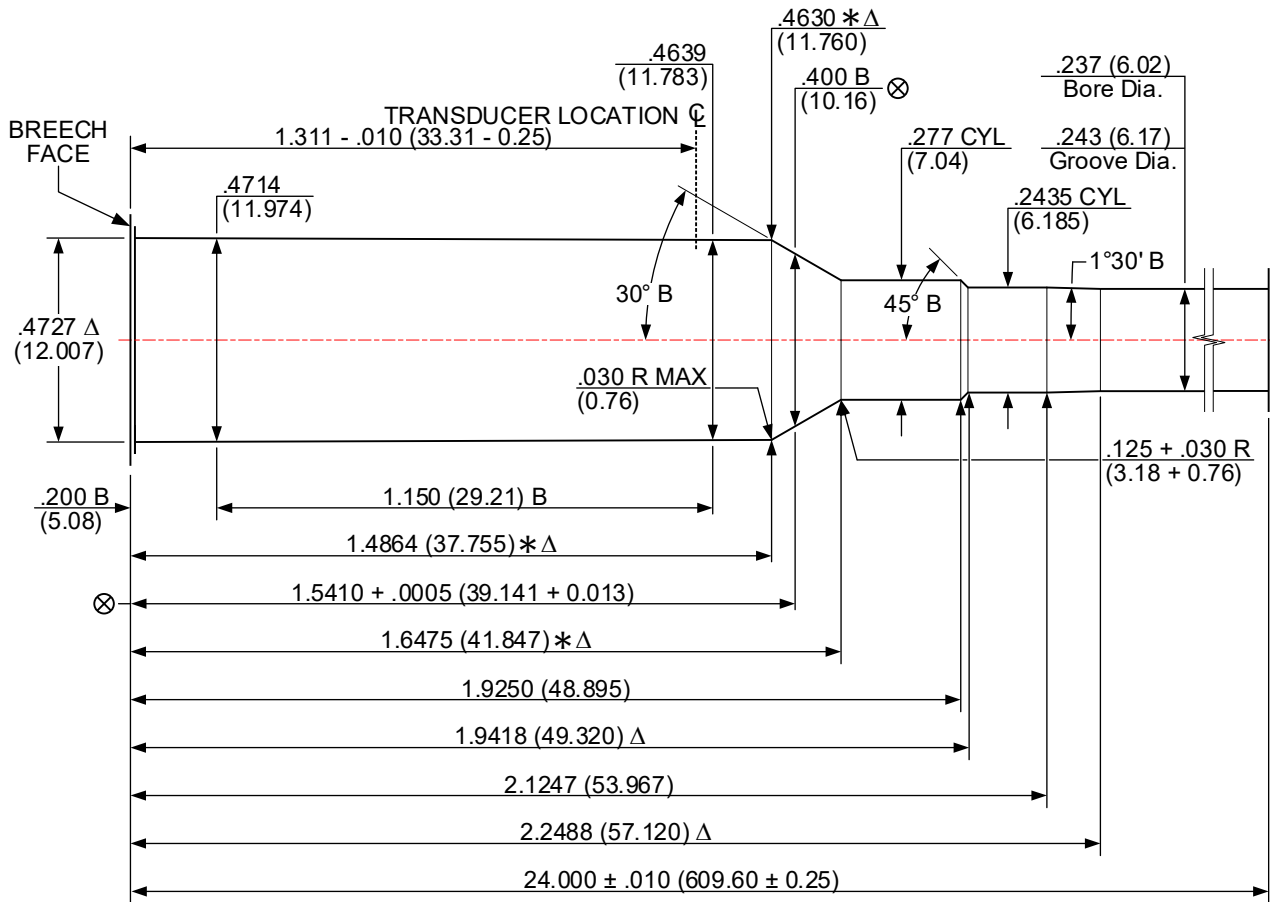

NUMBER OF GROOVES: 6
 WIDTH OF GROOVES: .090 + .002 (2.29 + 0.05)
 TWIST RATE: 7.50 (190.5) R.H.
 DIAMETER OF PISTON HOLE: Crusher pressures not established.
 TRANSDUCER DIAMETER: .250 (6.35)

LAND AND GROOVE DIMENSIONS TO BE
 WITHIN TOLERANCES THROUGHOUT
 LENGTH OF BARREL.

UNLESS OTHERWISE NOTED,
 ALL DIAMETERS +.0005 (0.013)
 LENGTH TOLERANCE + .005 (0.13)

DO NOT SCALE FROM DRAWING

NOTES:
 B = BASIC Δ = REFERENCE DIMENSION ⊗ = HEADSPACE DIMENSION
 * DIMENSIONS ARE TO INTERSECTIONS OF LINES (XX.XX) = MILLIMETERS
 ALL CALCULATIONS APPLY AT MAXIMUM MATERIAL CONDITION (MMC)

6MM GT [6MM GT]
V&P TEST BARREL

ISSUED: 01/16/2022 REVISED: 03/30/2024

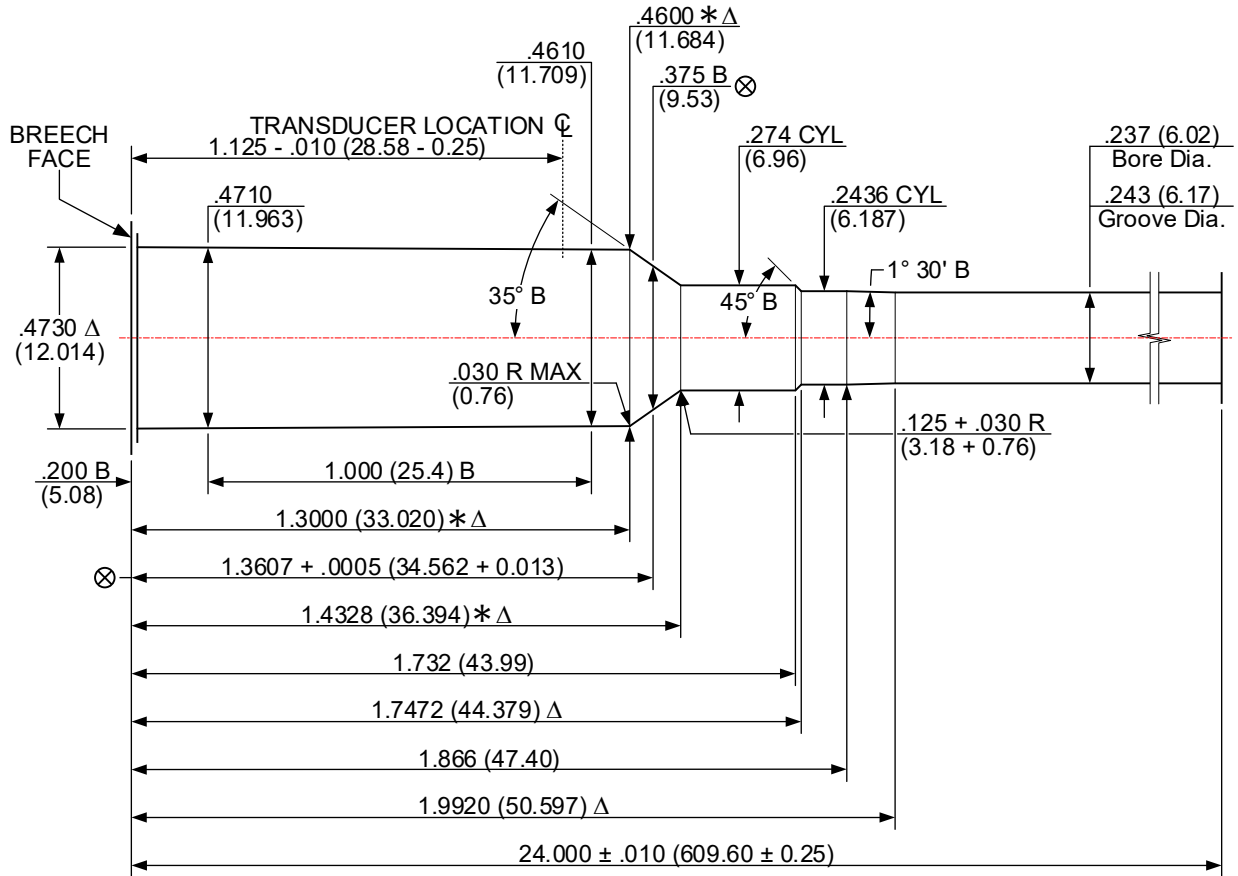

NUMBER OF GROOVES: 6
 WIDTH OF GROOVES: .090 + .002 (2.29 + 0.05)
 TWIST RATE: 7.50 (190.5) R.H.
 DIAMETER OF PISTON HOLE: Crusher pressures not established.
 TRANSDUCER DIAMETER: .250 (6.35)

LAND AND GROOVE DIMENSIONS TO BE
 WITHIN TOLERANCES THROUGHOUT
 LENGTH OF BARREL.

UNLESS OTHERWISE NOTED,
 ALL DIAMETERS +.0005 (0.013)
 LENGTH TOLERANCE + .005 (0.13)

DO NOT SCALE FROM DRAWING

NOTES:

B = BASIC

Δ = REFERENCE DIMENSION

⊗ = HEADSPACE DIMENSION

* DIMENSIONS ARE TO INTERSECTIONS OF LINES

(XX.XX) = MILLIMETERS

ALL CALCULATIONS APPLY AT MAXIMUM MATERIAL CONDITION (MMC)

6MM REMINGTON [6MM REM]
ISSUED: 05/20/1980 **V&P TEST BARREL** **REVISED: 01/31/2022**

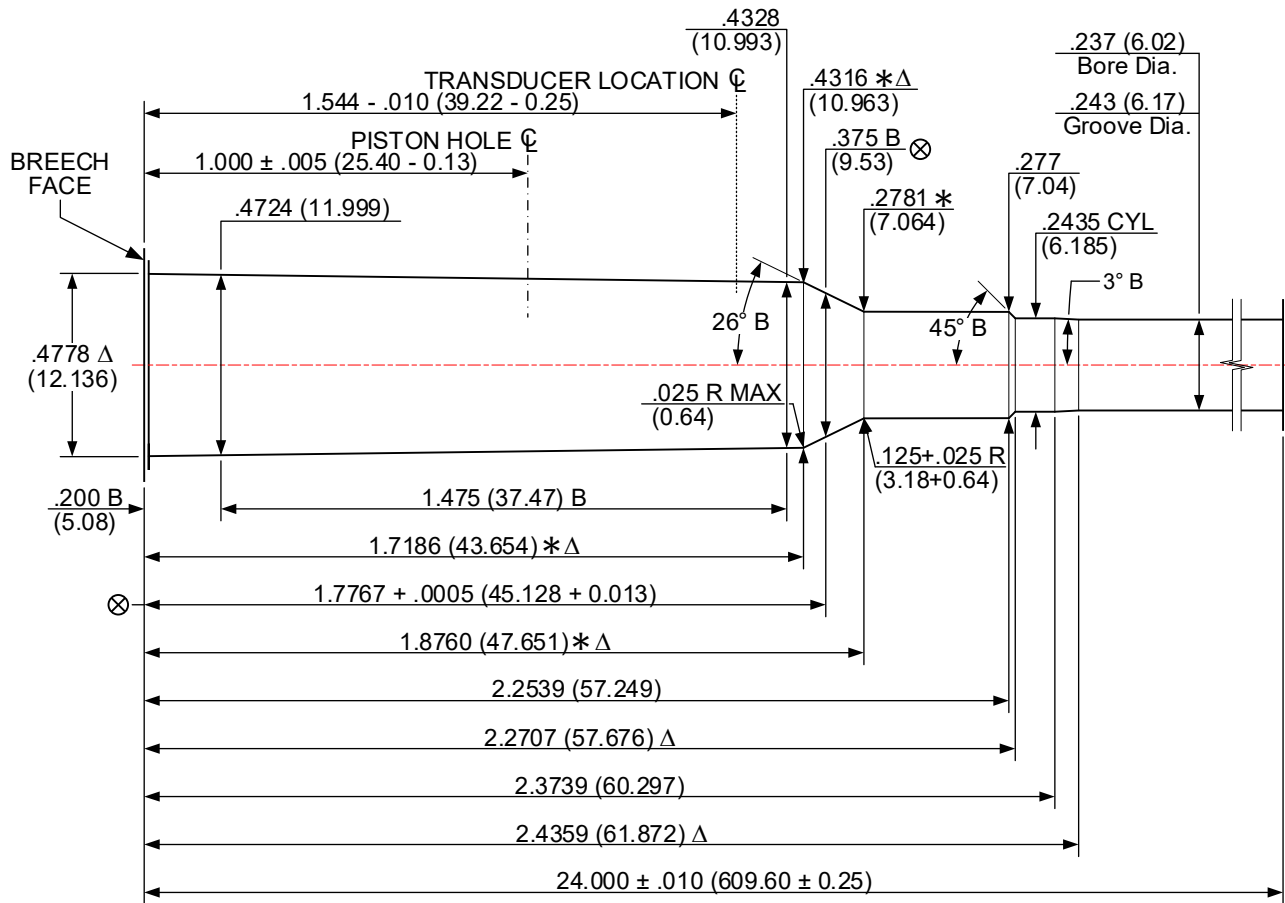

NUMBER OF GROOVES: 6
 WIDTH OF GROOVES: .090 + .002 (2.29 + 0.05)
 TWIST RATE: 9.00 (228.6) R.H.
 DIAMETER OF PISTON HOLE: .206 (5.23)
 TRANSDUCER DIAMETER: .250 (6.35)

LAND AND GROOVE DIMENSIONS TO BE
 WITHIN TOLERANCES THROUGHOUT
 LENGTH OF BARREL.

UNLESS OTHERWISE NOTED,
 ALL DIAMETERS +.0005 (0.013)
 LENGTH TOLERANCE + .005 (0.13)

DO NOT SCALE FROM DRAWING

NOTES:
 B = BASIC Δ = REFERENCE DIMENSION ⊗ = HEADSPACE DIMENSION
 * DIMENSIONS ARE TO INTERSECTIONS OF LINES (XX.XX) = MILLIMETERS
 ALL CALCULATIONS APPLY AT MAXIMUM MATERIAL CONDITION (MMC)

6.5 CREEDMOOR [6.5 CM]
 ISSUED: 06/17/2009 V&P TEST BARREL REVISED: 02/01/2022

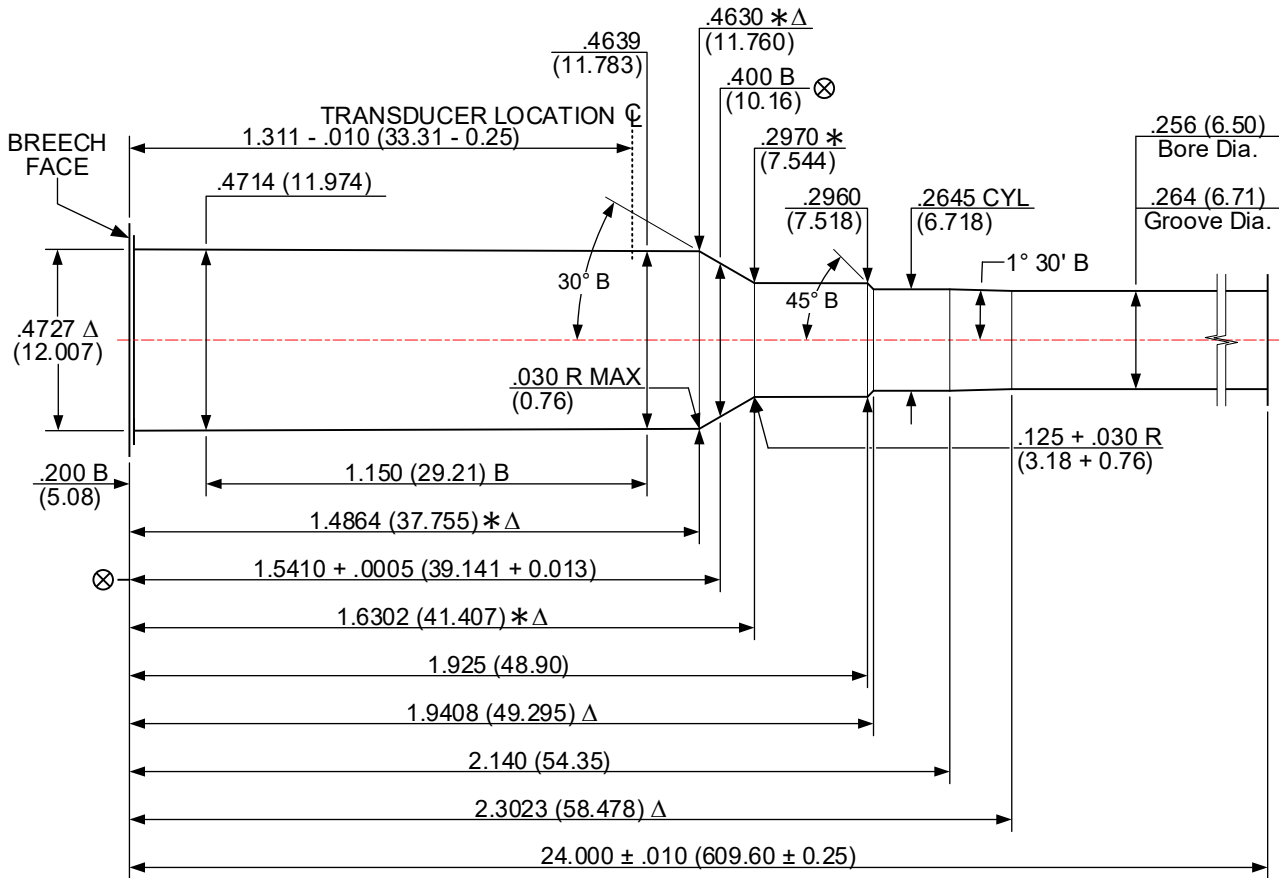

NUMBER OF GROOVES: 6
 WIDTH OF GROOVES: .090 + .002 (2.29 + 0.05)
 TWIST RATE: 8.00 (203.2) R.H.
 DIAMETER OF PISTON HOLE: Crusher pressures not established.
 TRANSDUCER DIAMETER: .250 (6.35)

LAND AND GROOVE DIMENSIONS TO BE
 WITHIN TOLERANCES THROUGHOUT
 LENGTH OF BARREL.

UNLESS OTHERWISE NOTED,
 ALL DIAMETERS +.0005 (0.013)
 LENGTH TOLERANCE + .005 (0.13)

DO NOT SCALE FROM DRAWING

NOTES:

B = BASIC

Δ = REFERENCE DIMENSION

⊗ = HEADSPACE DIMENSION

* DIMENSIONS ARE TO INTERSECTIONS OF LINES

(XX.XX) = MILLIMETERS

ALL CALCULATIONS APPLY AT MAXIMUM MATERIAL CONDITION (MMC)

6.5 GRENDSEL [6.5 GREN]
V&P TEST BARREL

ISSUED: 01/17/2011

REVISED: 02/01/2022

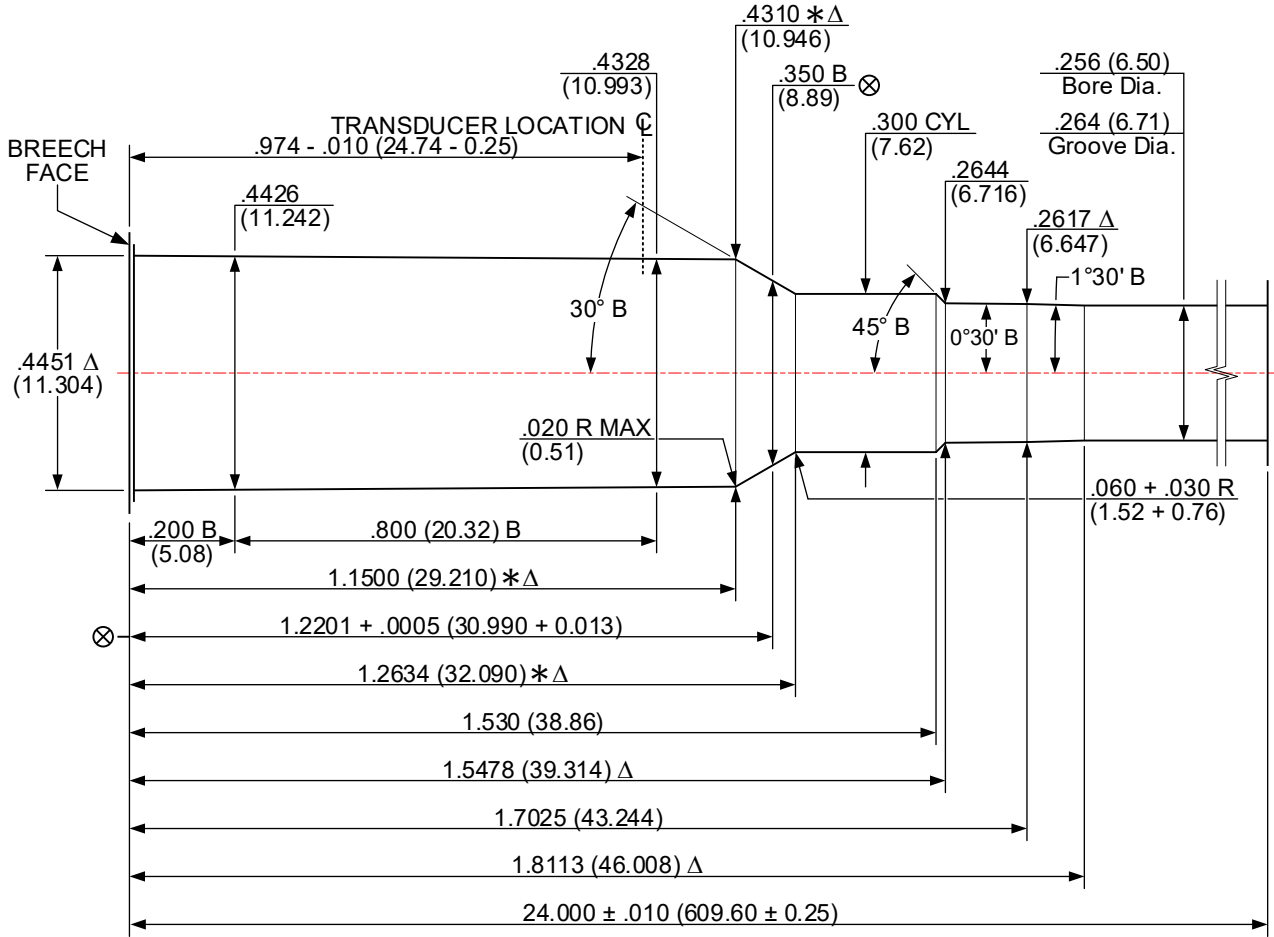

NUMBER OF GROOVES: 6
 WIDTH OF GROOVES: .090 + .002 (2.29 + 0.05)
 TWIST RATE: 8.00 (203.2) R.H.
 DIAMETER OF PISTON HOLE: Crusher pressures not established.
 TRANSDUCER DIAMETER: .250 (6.35)

LAND AND GROOVE DIMENSIONS TO BE
 WITHIN TOLERANCES THROUGHOUT
 LENGTH OF BARREL.

UNLESS OTHERWISE NOTED,
 ALL DIAMETERS +.0005 (0.013)
 LENGTH TOLERANCE + .005 (0.13)

DO NOT SCALE FROM DRAWING

NOTES:

B = BASIC

Δ = REFERENCE DIMENSION

⊗ = HEADSPACE DIMENSION

* DIMENSIONS ARE TO INTERSECTIONS OF LINES

(XX.XX) = MILLIMETERS

ALL CALCULATIONS APPLY AT MAXIMUM MATERIAL CONDITION (MMC)

6.5 PRECISION RIFLE CARTRIDGE [6.5 PRC]
 ISSUED: 06/13/2018 V&P TEST BARREL REVISED: 02/01/2022

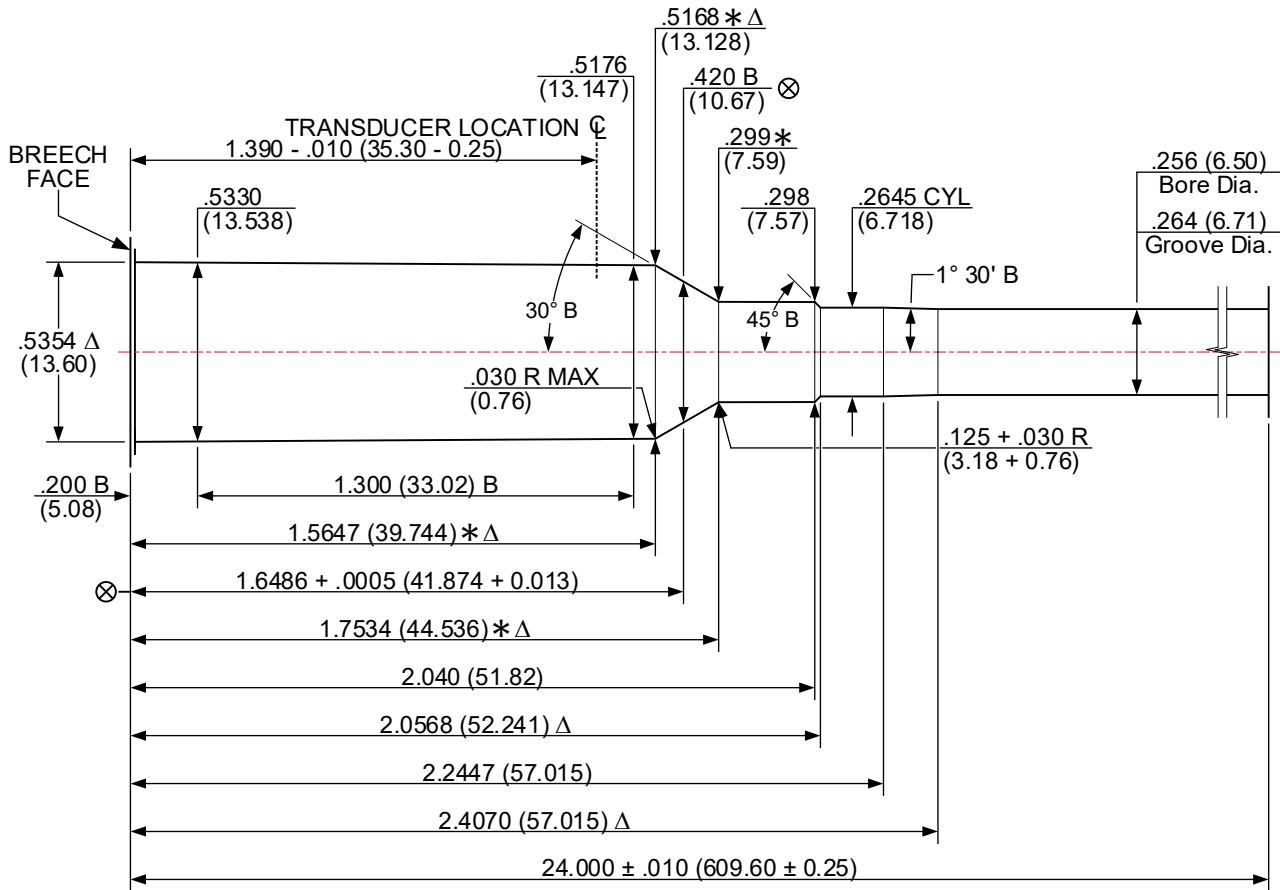

NUMBER OF GROOVES: 6
 WIDTH OF GROOVES: .090 + .002 (2.29 + 0.05)
 TWIST RATE: 8.00 (203.2) R.H.
 DIAMETER OF PISTON HOLE: Crusher pressures not established.
 TRANSDUCER DIAMETER: .250 (6.35)

LAND AND GROOVE DIMENSIONS TO BE
 WITHIN TOLERANCES THROUGHOUT
 LENGTH OF BARREL.

UNLESS OTHERWISE NOTED,
 ALL DIAMETERS +.0005 (0.013)
 LENGTH TOLERANCE + .005 (0.13)

DO NOT SCALE FROM DRAWING

NOTES:

B = BASIC

Δ = REFERENCE DIMENSION

⊗ = HEADSPACE DIMENSION

* DIMENSIONS ARE TO INTERSECTIONS OF LINES

(XX.XX) = MILLIMETERS

ALL CALCULATIONS APPLY AT MAXIMUM MATERIAL CONDITION (MMC)

6.5 WEATHERBY REBATED PRECISION MAGNUM [6.5 WBYP RPM]
 ISSUED: 09/23/2020 V&P TEST BARREL REVISED: 02/01/2022

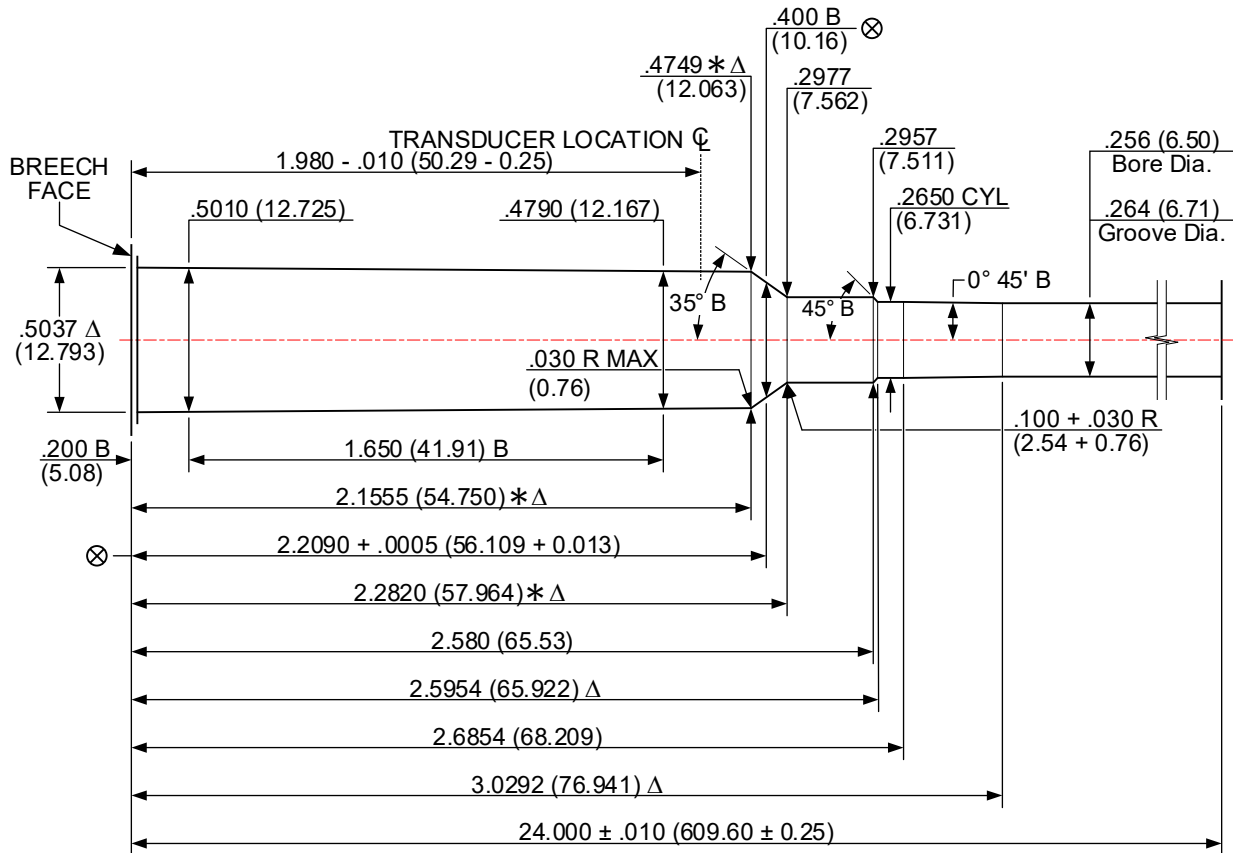

NUMBER OF GROOVES: 4
 WIDTH OF GROOVES: .147 + .002 (3.73 + 0.05)
 TWIST RATE: 8.00 (203.2) RH
 DIAMETER OF PISTON HOLE: Crusher pressures not established.
 TRANSDUCER DIAMETER: .250 (6.35)

LAND AND GROOVE DIMENSIONS TO BE
 WITHIN TOLERANCES THROUGHOUT
 LENGTH OF BARREL.

UNLESS OTHERWISE NOTED,
 ALL DIAMETERS +.0005 (0.013)
 LENGTH TOLERANCE + .005 (0.13)

DO NOT SCALE FROM DRAWING

NOTES:

B = BASIC

Δ = REFERENCE DIMENSION

⊗ = HEADSPACE DIMENSION

* DIMENSIONS ARE TO INTERSECTIONS OF LINES

(XX.XX) = MILLIMETERS

ALL CALCULATIONS APPLY AT MAXIMUM MATERIAL CONDITION (MMC)

6.5-284 NORMA [6.5-284 NORMA]
 ISSUED: 06/18/2019 V&P TEST BARREL REVISED: 10/11/2024

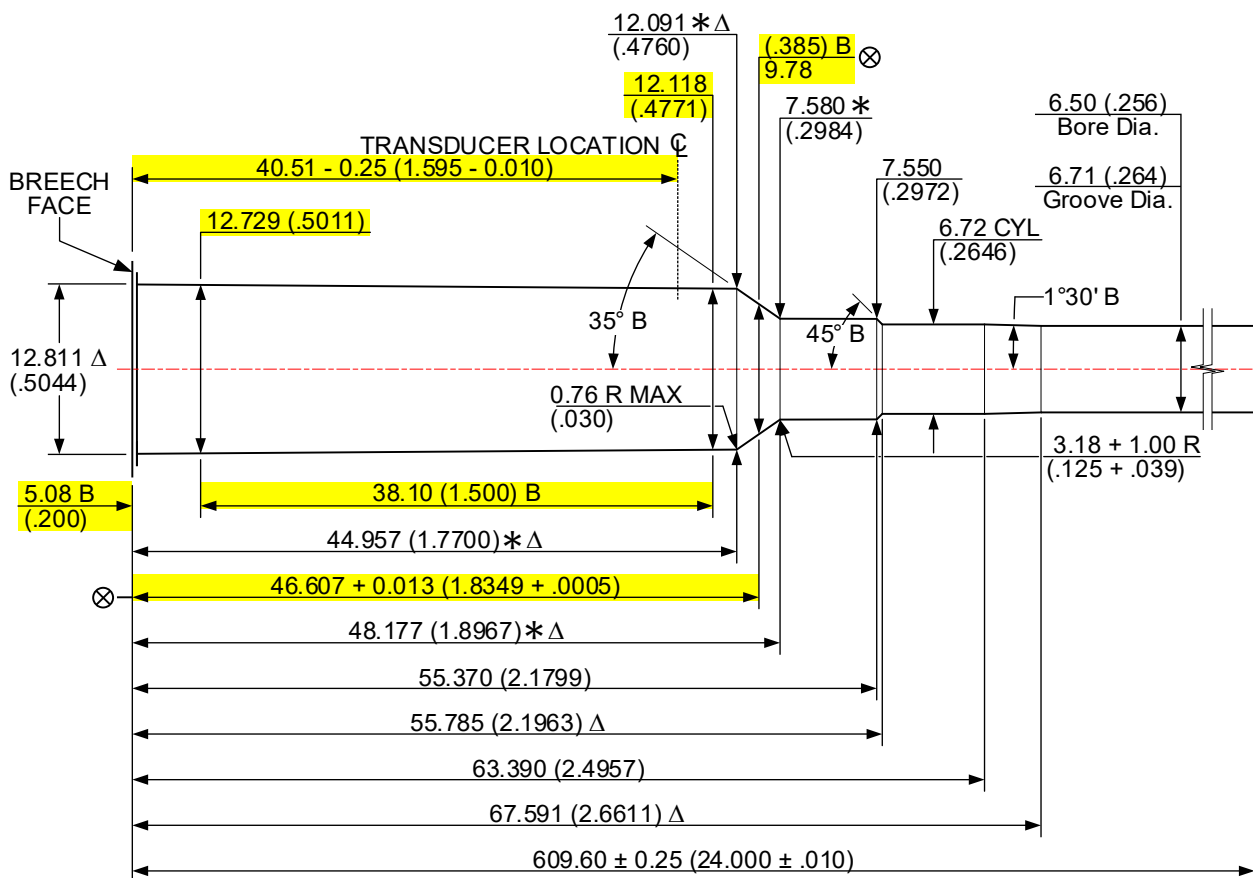

HIGHLIGHTED DIMENSIONS HAVE NO CORRESPONDING C.I.P. ANALOG. THE METRIC UNITS FOR THESE ARE THE ORIGINAL VALUES; U.S. CUSTOMARY VALUES ARE CALCULATED AND ROUNDED.

NUMBER OF GROOVES: 6
 WIDTH OF GROOVES: 2.29+0.05 (.090+.002) WIDE
 TWIST RATE: 228.0 (9.00) R.H.
 DIAMETER OF PISTON HOLE: Crusher pressures not established.
 TRANSDUCER DIAMETER: 6.35 (.250)

LAND AND GROOVE DIMENSIONS TO BE WITHIN TOLERANCES THROUGHOUT LENGTH OF BARREL.

UNLESS OTHERWISE NOTED, ALL DIAMETERS +.0005 (0.013) LENGTH TOLERANCE + .005 (0.13)

DO NOT SCALE FROM DRAWING

NOTES:

- B = BASIC
- * DIMENSIONS ARE TO INTERSECTIONS OF LINES
- ALL CALCULATIONS APPLY AT MAXIMUM MATERIAL CONDITION (MMC)
- Δ = REFERENCE DIMENSION
- ⊗ = HEADSPACE DIMENSION
- (XX.XX) = MILLIMETERS

NOTICE: This drawing is subject to change. Revisions, if applicable, are available at www.saami.org.

METRIC METRIC METRIC METRIC METRIC

6.5-300 WEATHERBY MAGNUM [6.5-300 WBY MAG]
 ISSUED: 01/16/2017 V&P TEST BARREL REVISED: 01/21/2024

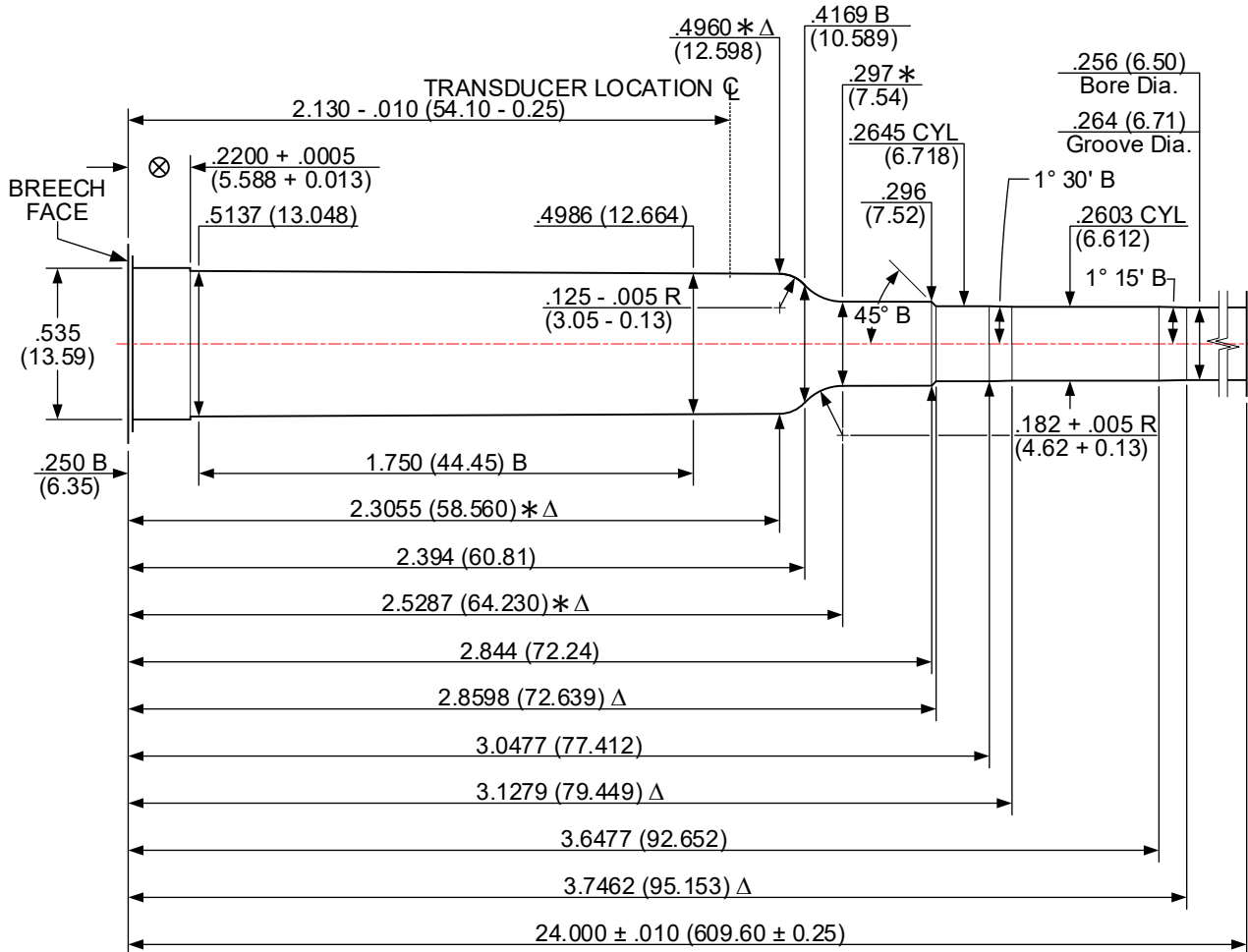

NUMBER OF GROOVES: 6
 WIDTH OF GROOVES: .095 + .002 (2.41 + 0.05)
 TWIST RATE: 8.00 (203.2) R.H.
 DIAMETER OF PISTON HOLE: Crusher Pressures Not Established
 TRANSDUCER DIAMETER: .250 (6.35)

LAND AND GROOVE DIMENSIONS TO BE
 WITHIN TOLERANCES THROUGHOUT
 LENGTH OF BARREL.

UNLESS OTHERWISE NOTED,
 ALL DIAMETERS +.0005 (0.013)
 LENGTH TOLERANCE + .005 (0.13)

DO NOT SCALE FROM DRAWING

NOTES:
 B = BASIC Δ = REFERENCE DIMENSION ⊗ = HEADSPACE DIMENSION
 * DIMENSIONS ARE TO INTERSECTIONS OF LINES (XX.XX) = MILLIMETERS
 ALL CALCULATIONS APPLY AT MAXIMUM MATERIAL CONDITION (MMC)

6.5X55 SWEDISH [6.5X55]
 ISSUED: 07/28/1993 V&P TEST BARREL REVISED: 02/02/2022

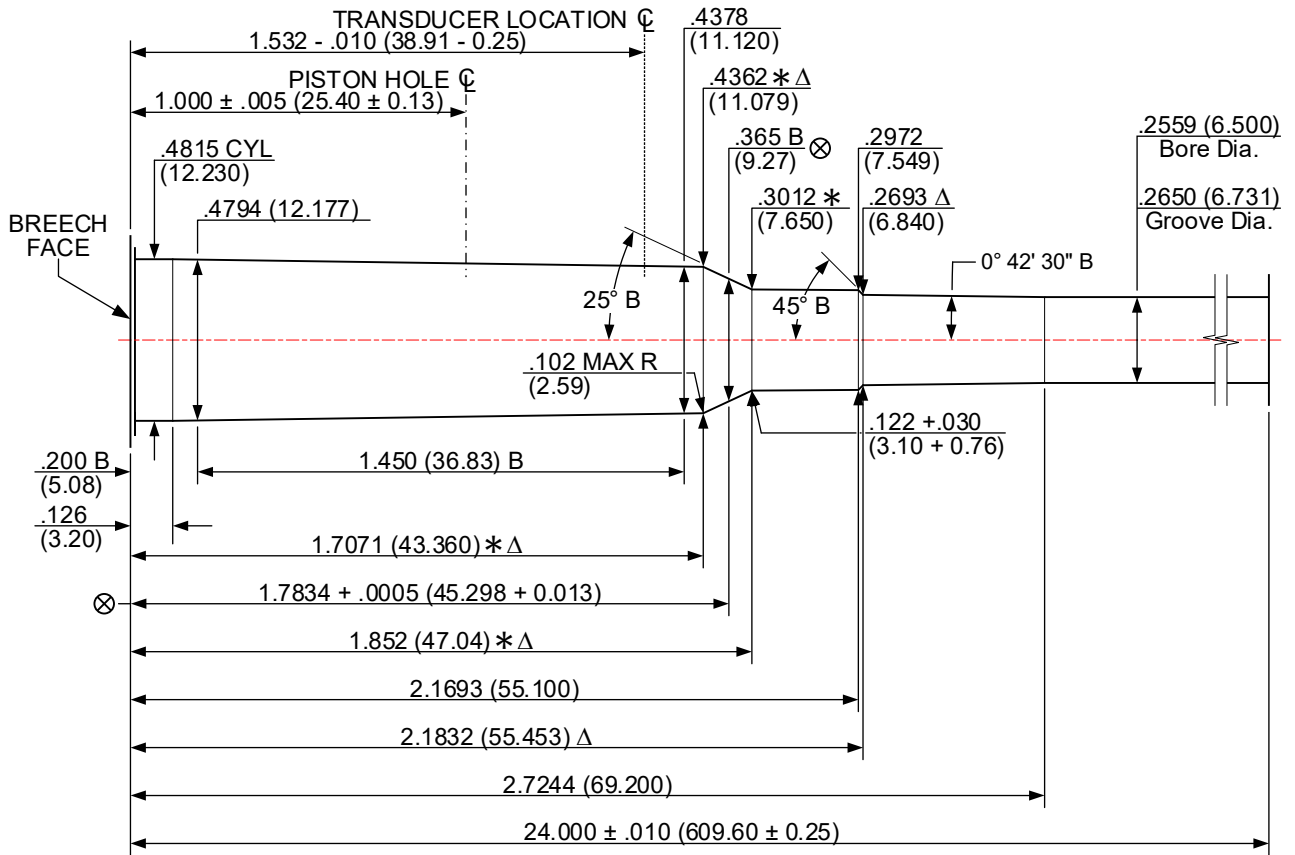

NUMBER OF GROOVES: 4
 WIDTH OF GROOVES: $.098 + .002$ (2.49 + 0.05)
 TWIST RATE: 8.00 (203.2) R.H.
 DIAMETER OF PISTON HOLE: .206 (5.23)
 TRANSDUCER DIAMETER: .250 (6.35)

LAND AND GROOVE DIMENSIONS TO BE
 WITHIN TOLERANCES THROUGHOUT
 LENGTH OF BARREL.

UNLESS OTHERWISE NOTED,
 ALL DIAMETERS +.0005 (0.013)
 LENGTH TOLERANCE + .005 (0.13)

DO NOT SCALE FROM DRAWING

NOTES:

B = BASIC

Δ = REFERENCE DIMENSION

⊗ = HEADSPACE DIMENSION

* DIMENSIONS ARE TO INTERSECTIONS OF LINES

(XX.XX) = MILLIMETERS

ALL CALCULATIONS APPLY AT MAXIMUM MATERIAL CONDITION (MMC)

6.8 TRUE VELOCITY COMPOSITE (6.8 TVC)

ISSUED: 01/16/2022

V&P TEST BARREL

REVISED: 12/13/2023

WARNING: Maximum Average Pressure levels greater than 65,000 psi may present increased risk of unsafe cartridge case or firearm rupture and thus require cartridge case and/or firearm designs that depart from traditional practices (materials, construction, and other design criteria).

NOTE: This design is based on a polymer case. Typical dimensional tolerances and relationships between the cartridge and chamber dimensions may deviate from conventional designs.

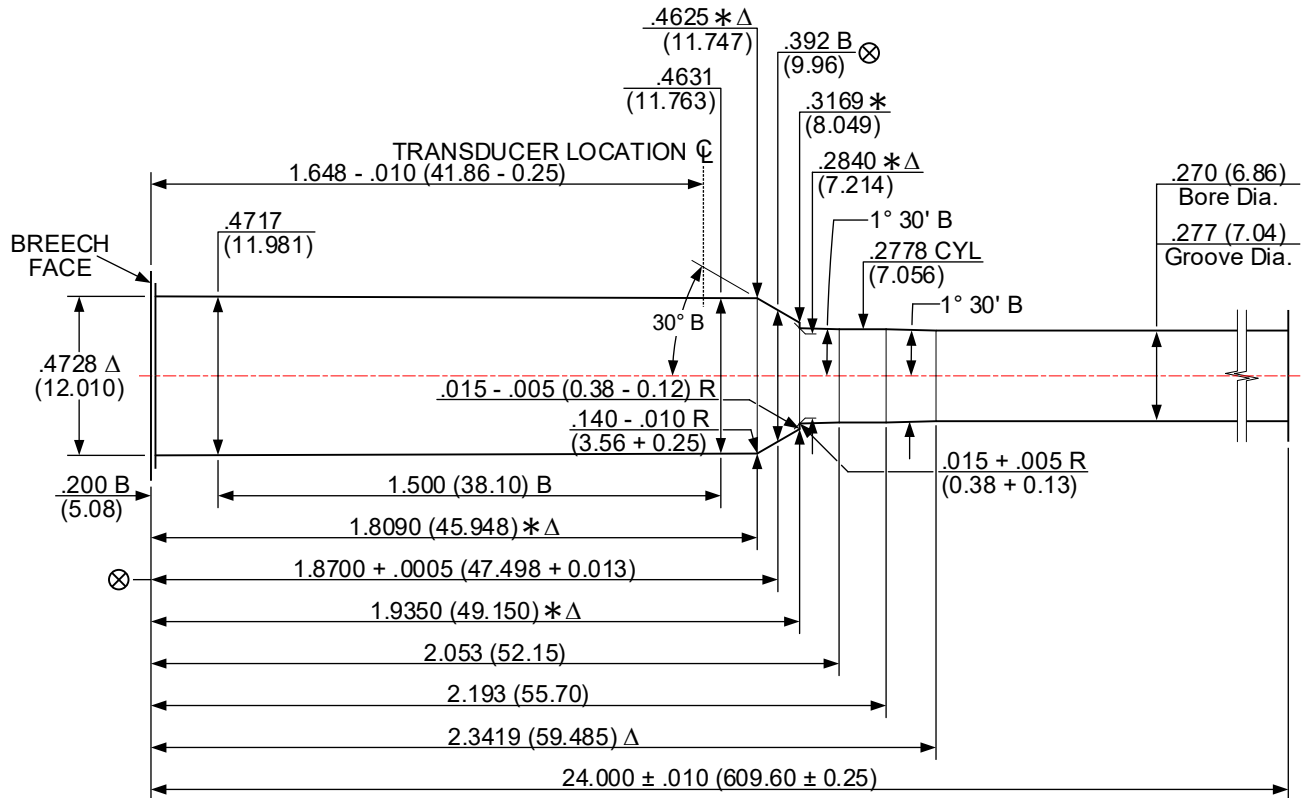

NUMBER OF GROOVES: 5

WIDTH OF GROOVES: .120 + .002 (3.05 + 0.05)

TWIST RATE: 8.00 (203.2) R.H.

DIAMETER OF PISTON HOLE: Crusher pressures not established.

TRANSDUCER DIAMETER: .250 (6.35) DIAMETER / .50 (12.7) THREAD

LAND AND GROOVE DIMENSIONS TO BE
 WITHIN TOLERANCES THROUGHOUT
 LENGTH OF BARREL.

UNLESS OTHERWISE NOTED,
 ALL DIAMETERS +.0005 (0.013)
 LENGTH TOLERANCE + .005 (0.13)

DO NOT SCALE FROM DRAWING

NOTES:

B = BASIC

Δ = REFERENCE DIMENSION

\otimes = HEADSPACE DIMENSION

* DIMENSIONS ARE TO INTERSECTIONS OF LINES

(XX.XX) = MILLIMETERS

ALL CALCULATIONS APPLY AT MAXIMUM MATERIAL CONDITION (MMC)

6.8 WESTERN [6.8 WESTERN]
ISSUED: 09/23/2020 V&P TEST BARREL REVISED: 02/03/2022

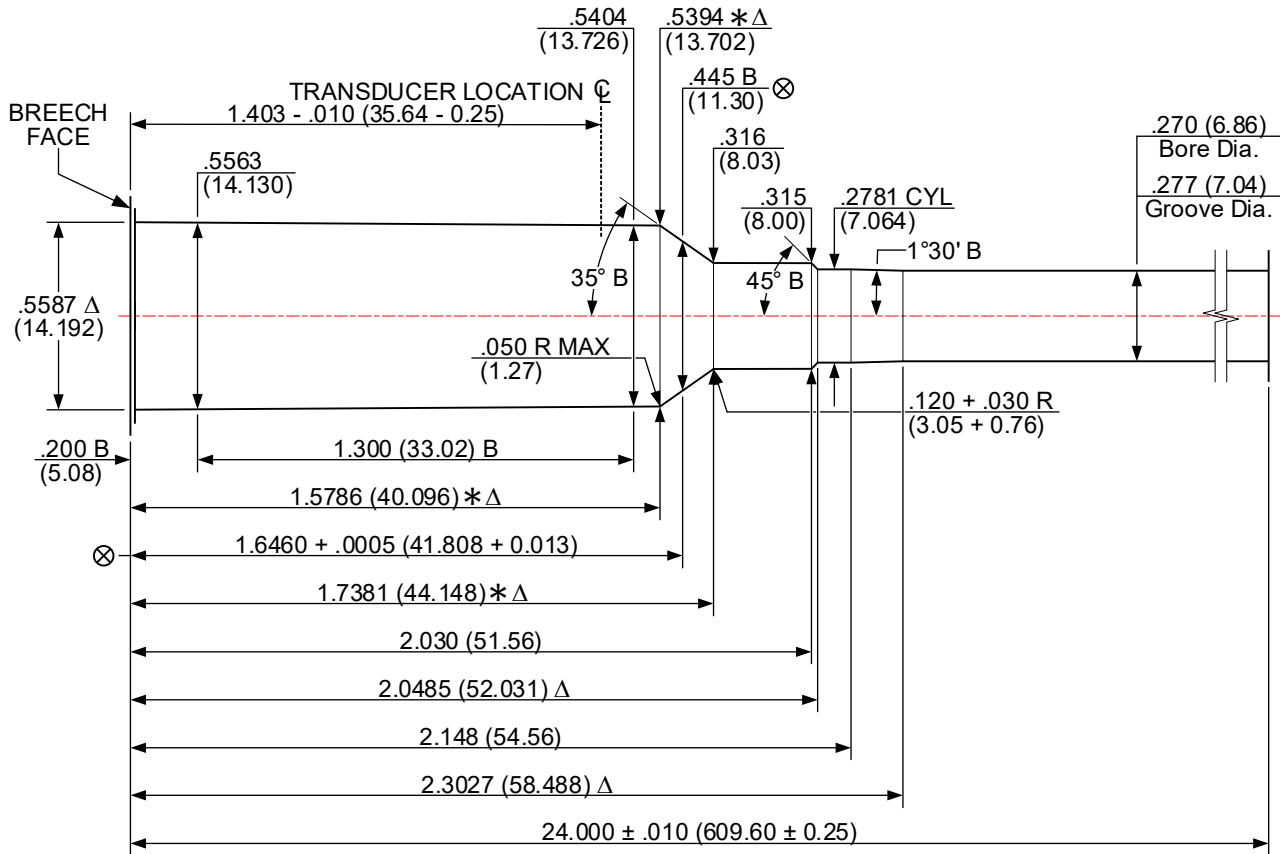

NUMBER OF GROOVES: 6
 WIDTH OF GROOVES: .095 + .002 (2.41 + 0.05)
 TWIST RATE: 8.00 (203.2) RH
 DIAMETER OF PISTON HOLE: Crusher pressures not established
 TRANSDUCER DIAMETER: .250 (6.35)

LAND AND GROOVE DIMENSIONS TO BE
 WITHIN TOLERANCES THROUGHOUT
 LENGTH OF BARREL.

UNLESS OTHERWISE NOTED,
 ALL DIAMETERS +.0005 (0.013)
 LENGTH TOLERANCE + .005 (0.13)

DO NOT SCALE FROM DRAWING

NOTES:

B = BASIC

Δ = REFERENCE DIMENSION

⊗ = HEADSPACE DIMENSION

* DIMENSIONS ARE TO INTERSECTIONS OF LINES

(XX.XX) = MILLIMETERS

ALL CALCULATIONS APPLY AT MAXIMUM MATERIAL CONDITION (MMC)

6.8MM REMINGTON SPC [6.8MM REM SPC]
ISSUED: 06/23/2004 **V&P TEST BARREL** **REVISED: 10/26/2022**

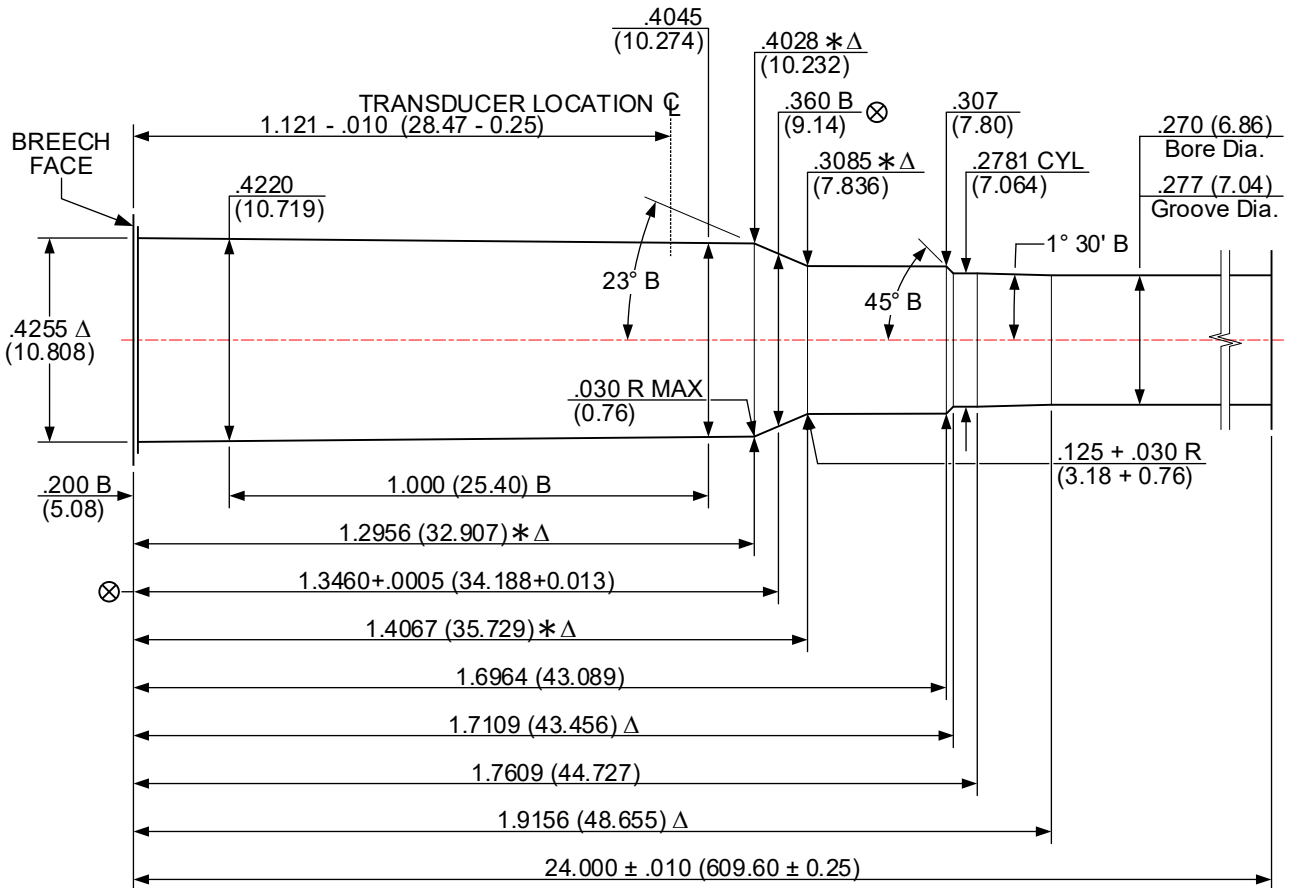

NUMBER OF GROOVES: 4
 WIDTH OF GROOVES: $.160 + .002$ (4.06 + 0.05)
 TWIST RATE: 10.00 (254.0) R.H.
 DIAMETER OF PISTON HOLE: Crusher pressures not established
 TRANSDUCER DIAMETER: $.250$ (6.35)

LAND AND GROOVE DIMENSIONS TO BE
 WITHIN TOLERANCES THROUGHOUT
 LENGTH OF BARREL.

UNLESS OTHERWISE NOTED,
 ALL DIAMETERS $+ .0005$ (0.013)
 LENGTH TOLERANCE $+ .005$ (0.13)

DO NOT SCALE FROM DRAWING

NOTES:

- B = BASIC
- Δ = REFERENCE DIMENSION
- ⊗ = HEADSPACE DIMENSION
- * DIMENSIONS ARE TO INTERSECTIONS OF LINES
- (XX.XX) = MILLIMETERS
- ALL CALCULATIONS APPLY AT MAXIMUM MATERIAL CONDITION (MMC)

7MM MAUSER (7 X 57) [7MM (7 X 57)]
 ISSUED: 01/29/1997 V&P TEST BARREL REVISED: 05/29/2024

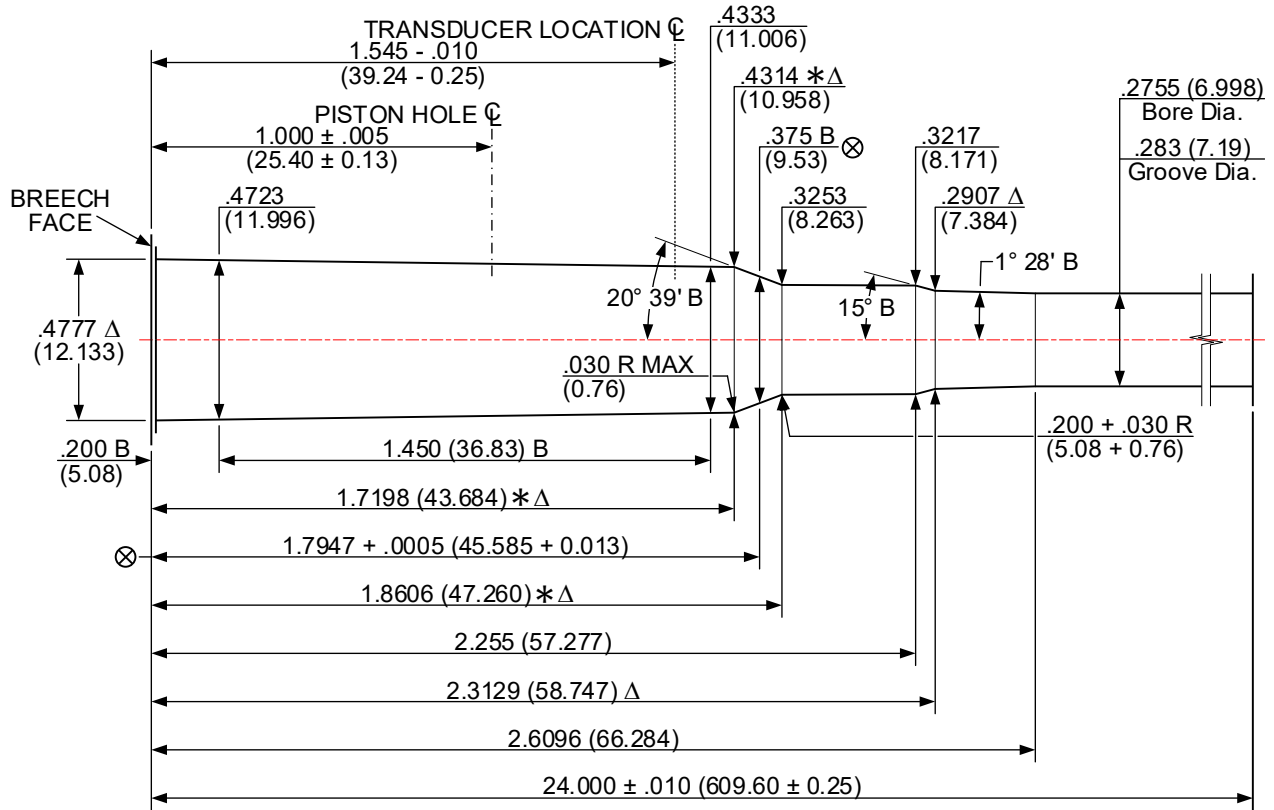

NUMBER OF GROOVES: 4
 WIDTH OF GROOVES: $.160 + .002$ (4.06 + 0.05)
 TWIST RATE: 8.75 (222.3) [Direction not specified]
 DIAMETER OF PISTON HOLE: $.206$ (5.23)
 TRANSDUCER DIAMETER: $.250$ (6.35)

LAND AND GROOVE DIMENSIONS TO BE
 WITHIN TOLERANCES THROUGHOUT
 LENGTH OF BARREL.

UNLESS OTHERWISE NOTED,
 ALL DIAMETERS $+ .0005$ (0.013)
 LENGTH TOLERANCE $+ .005$ (0.13)

DO NOT SCALE FROM DRAWING

NOTES:

- B = BASIC
- * DIMENSIONS ARE TO INTERSECTIONS OF LINES
- ALL CALCULATIONS APPLY AT MAXIMUM MATERIAL CONDITION (MMC)
- Δ = REFERENCE DIMENSION
- ⊗ = HEADSPACE DIMENSION
- (XX.XX) = MILLIMETERS

7MM PRECISION RIFLE CARTRIDGE [7MM PRC]
 ISSUED: 06/07/2022 V&P TEST BARREL REVISED: - / - / - - -

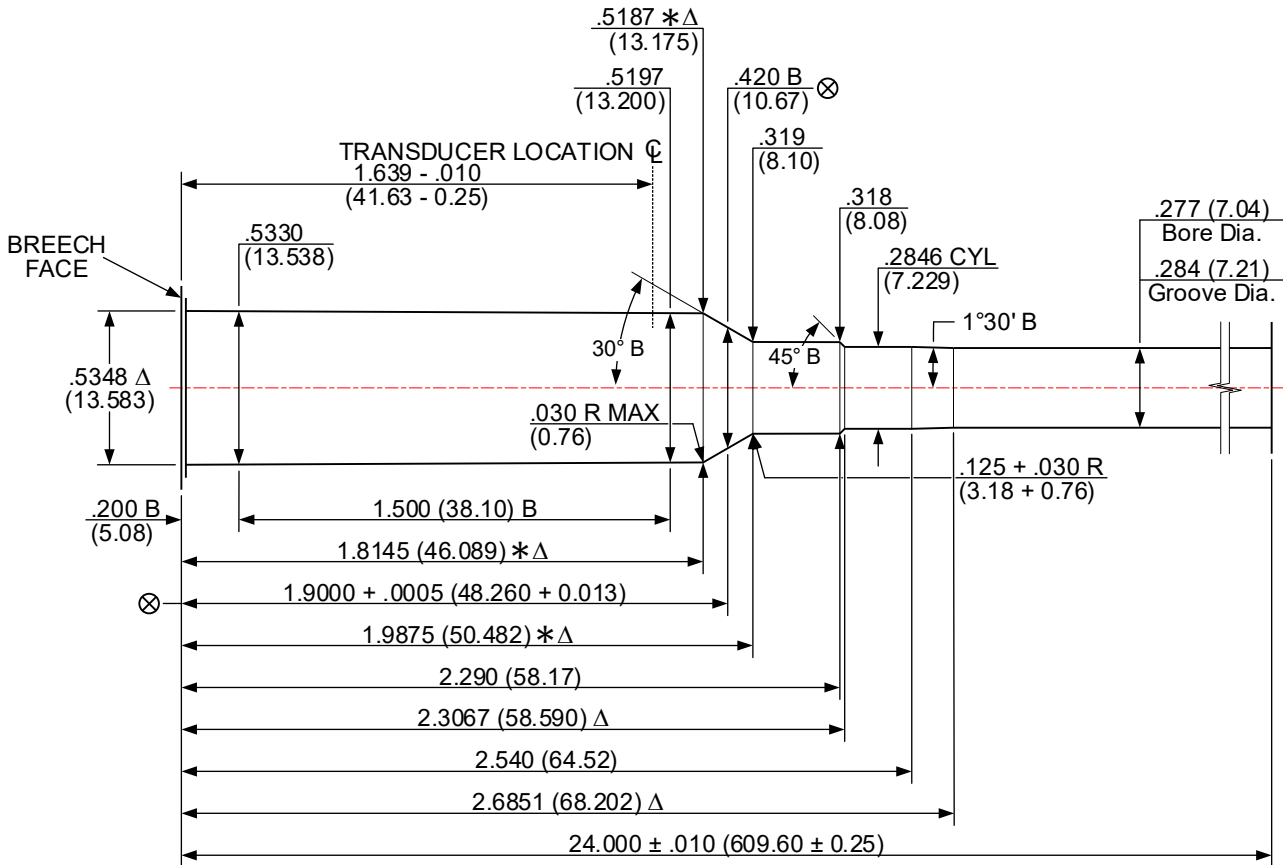

NUMBER OF GROOVES: 6
 WIDTH OF GROOVES: .110 + .002 (2.79 + 0.05)
 TWIST RATE: 8.00 (203.2) R.H.
 DIAMETER OF PISTON HOLE: Crusher pressures not established.
 TRANSDUCER DIAMETER: .250 (6.35)

LAND AND GROOVE DIMENSIONS TO BE
 WITHIN TOLERANCES THROUGHOUT
 LENGTH OF BARREL.

UNLESS OTHERWISE NOTED,
 ALL DIAMETERS +.0005 (0.013)
 LENGTH TOLERANCE + .005 (0.13)

DO NOT SCALE FROM DRAWING

NOTES:

B = BASIC

Δ = REFERENCE DIMENSION

⊗ = HEADSPACE DIMENSION

* DIMENSIONS ARE TO INTERSECTIONS OF LINES

(XX.XX) = MILLIMETERS

ALL CALCULATIONS APPLY AT MAXIMUM MATERIAL CONDITION (MMC)

7MM REMINGTON ULTRA MAGNUM [7MM REM ULTRA MAG]
 ISSUED: 01/10/2001 V&P TEST BARREL REVISED: 10/07/2022

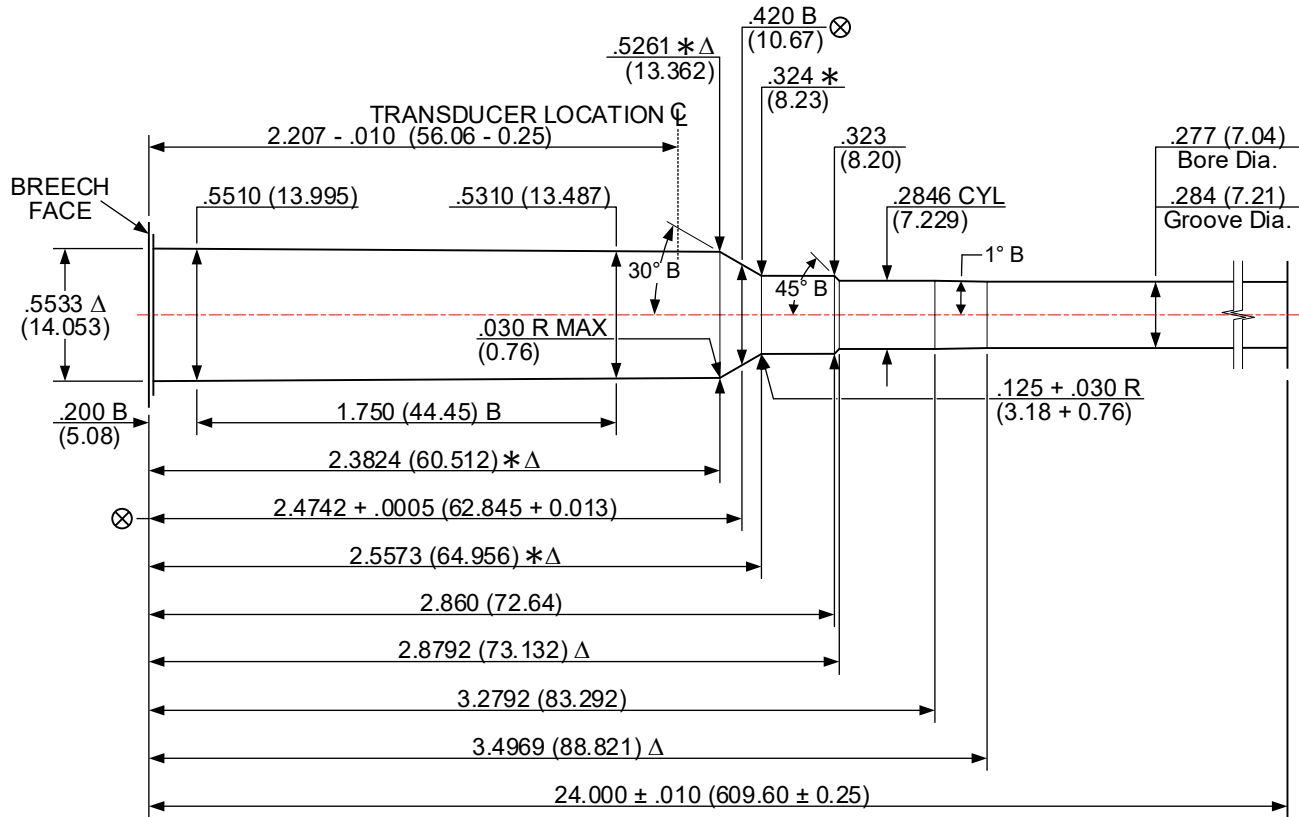

NUMBER OF GROOVES: 6
 WIDTH OF GROOVES: $.110 + .002$ (2.79 + 0.05)
 TWIST RATE: 9.50 (241.3) R.H.
 DIAMETER OF PISTON HOLE: Crusher pressures not established
 TRANSDUCER DIAMETER: $.250$ (6.35)

LAND AND GROOVE DIMENSIONS TO BE
 WITHIN TOLERANCES THROUGHOUT
 LENGTH OF BARREL.

UNLESS OTHERWISE NOTED,
 ALL DIAMETERS $+ .0005$ (0.013)
 LENGTH TOLERANCE $+ .005$ (0.13)

DO NOT SCALE FROM DRAWING

NOTES:

B = BASIC

Δ = REFERENCE DIMENSION

\otimes = HEADSPACE DIMENSION

* DIMENSIONS ARE TO INTERSECTIONS OF LINES

(XX.XX) = MILLIMETERS

ALL CALCULATIONS APPLY AT MAXIMUM MATERIAL CONDITION (MMC)

7MM WEATHERBY MAGNUM [7MM WBY MAG]
 ISSUED: 06/04/1991 V&P TEST BARREL REVISED: 01/21/2024

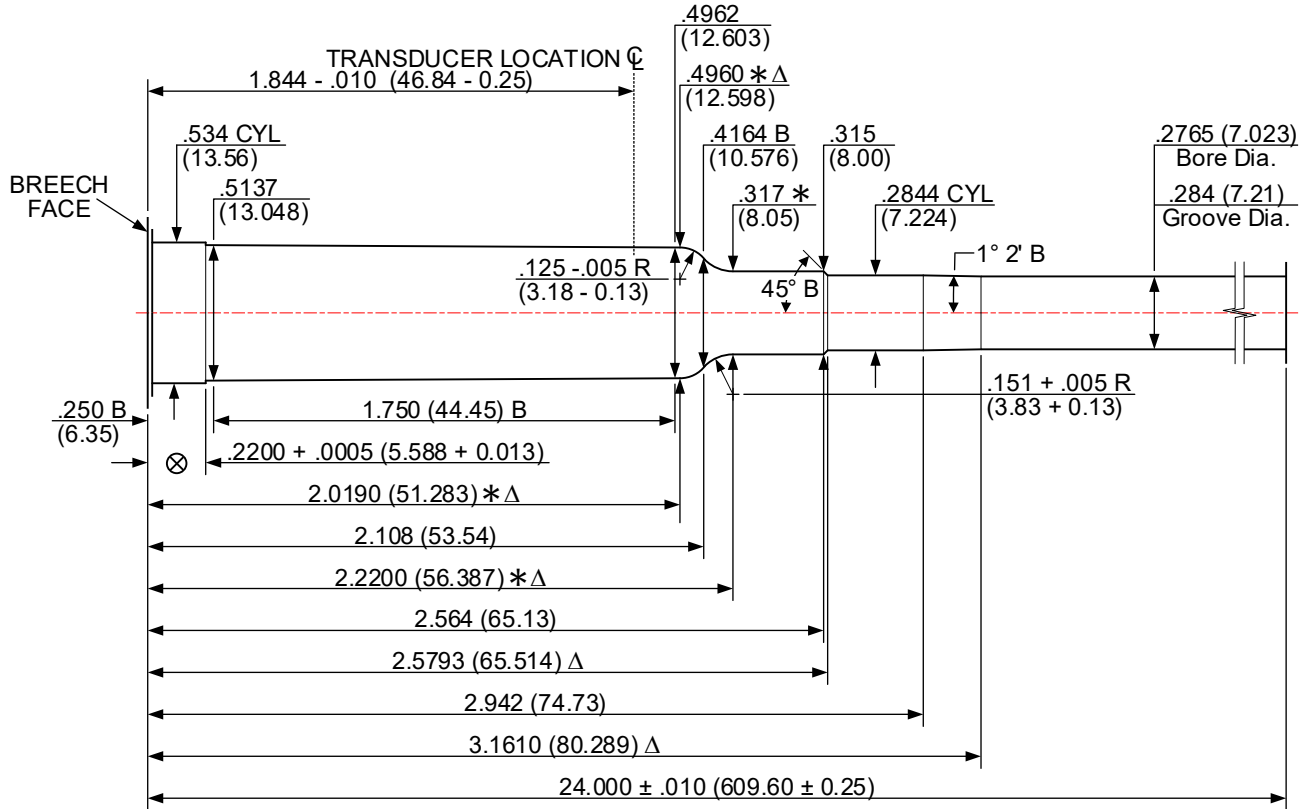

NUMBER OF GROOVES: 6
 WIDTH OF GROOVES: .113 + .002 (2.87 + 0.05)
 TWIST RATE: 10.00 (254.0) R.H.
 DIAMETER OF PISTON HOLE: Crusher pressure not established.
 TRANSDUCER DIAMETER: .250 (6.35)

LAND AND GROOVE DIMENSIONS TO BE
 WITHIN TOLERANCES THROUGHOUT
 LENGTH OF BARREL.

UNLESS OTHERWISE NOTED,
 ALL DIAMETERS +.0005 (0.013)
 LENGTH TOLERANCE + .005 (0.13)

DO NOT SCALE FROM DRAWING

NOTES:
 B = BASIC Δ = REFERENCE DIMENSION ⊗ = HEADSPACE DIMENSION
 * DIMENSIONS ARE TO INTERSECTIONS OF LINES (XX.XX) = MILLIMETERS
 ALL CALCULATIONS APPLY AT MAXIMUM MATERIAL CONDITION (MMC)

7MM WINCHESTER SHORT MAGNUM [7MM WSM]
 ISSUED: 05/31/2003 V&P TEST BARREL REVISED: 10/07/2022

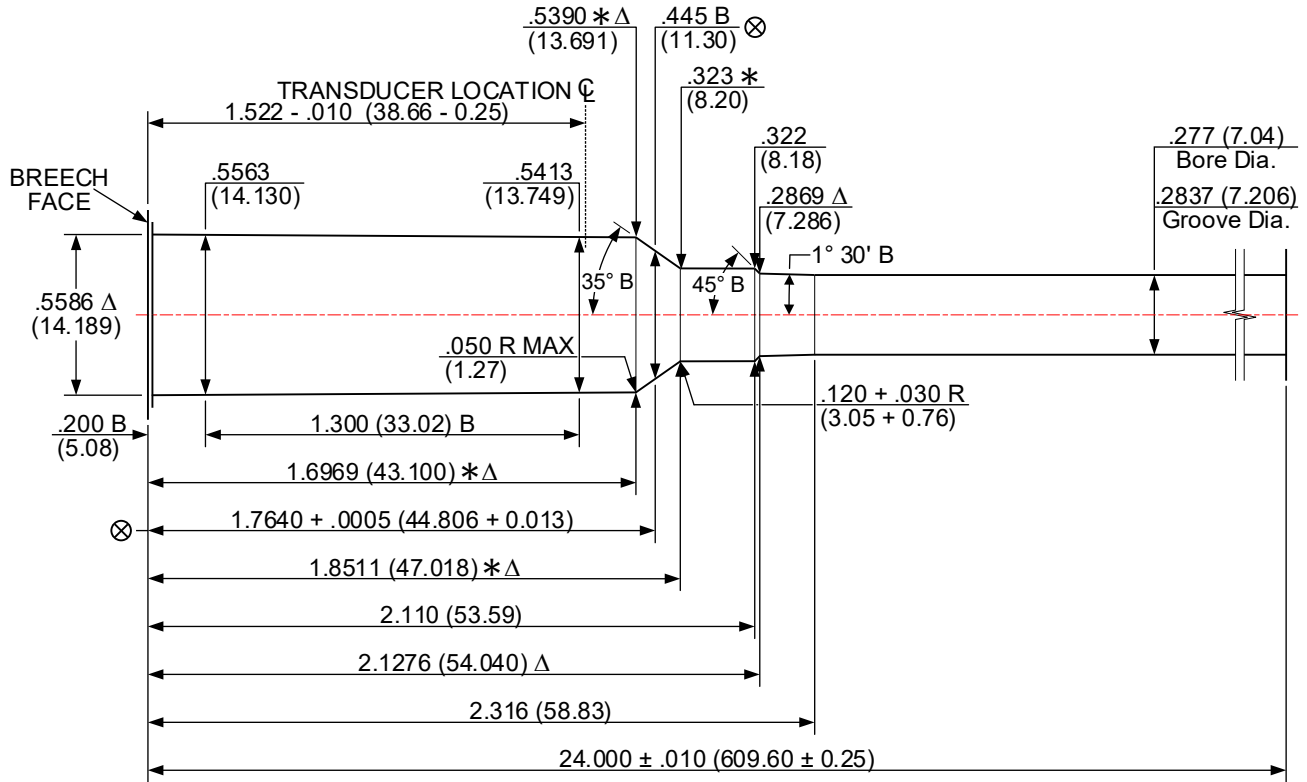

NUMBER OF GROOVES: 6
 WIDTH OF GROOVES: $.110 + .002$ (2.79 + 0.05)
 TWIST RATE: 9.50 (241.3) R.H.
 DIAMETER OF PISTON HOLE: Crusher pressures not established
 TRANSUDCER DIAMETER: $.250$ (6.35)

LAND AND GROOVE DIMENSIONS TO BE
 WITHIN TOLERANCES THROUGHOUT
 LENGTH OF BARREL.

UNLESS OTHERWISE NOTED,
 ALL DIAMETERS $+ .0005$ (0.013)
 LENGTH TOLERANCE $+ .005$ (0.13)

DO NOT SCALE FROM DRAWING

NOTE:

B = BASIC

Δ = REFERENCE DIMENSION

\otimes = HEADSPACE DIMENSION

* DIMENSIONS ARE TO INTERSECTIONS OF LINES

(XX.XX) = MILLIMETERS

ALL CALCULATIONS APPLY AT MAXIMUM MATERIAL CONDITION (MMC)

7MM-08 REMINGTON [7MM-08 REM]
 ISSUED: 05/20/1980 V&P TEST BARREL REVISED: 10/24/2022

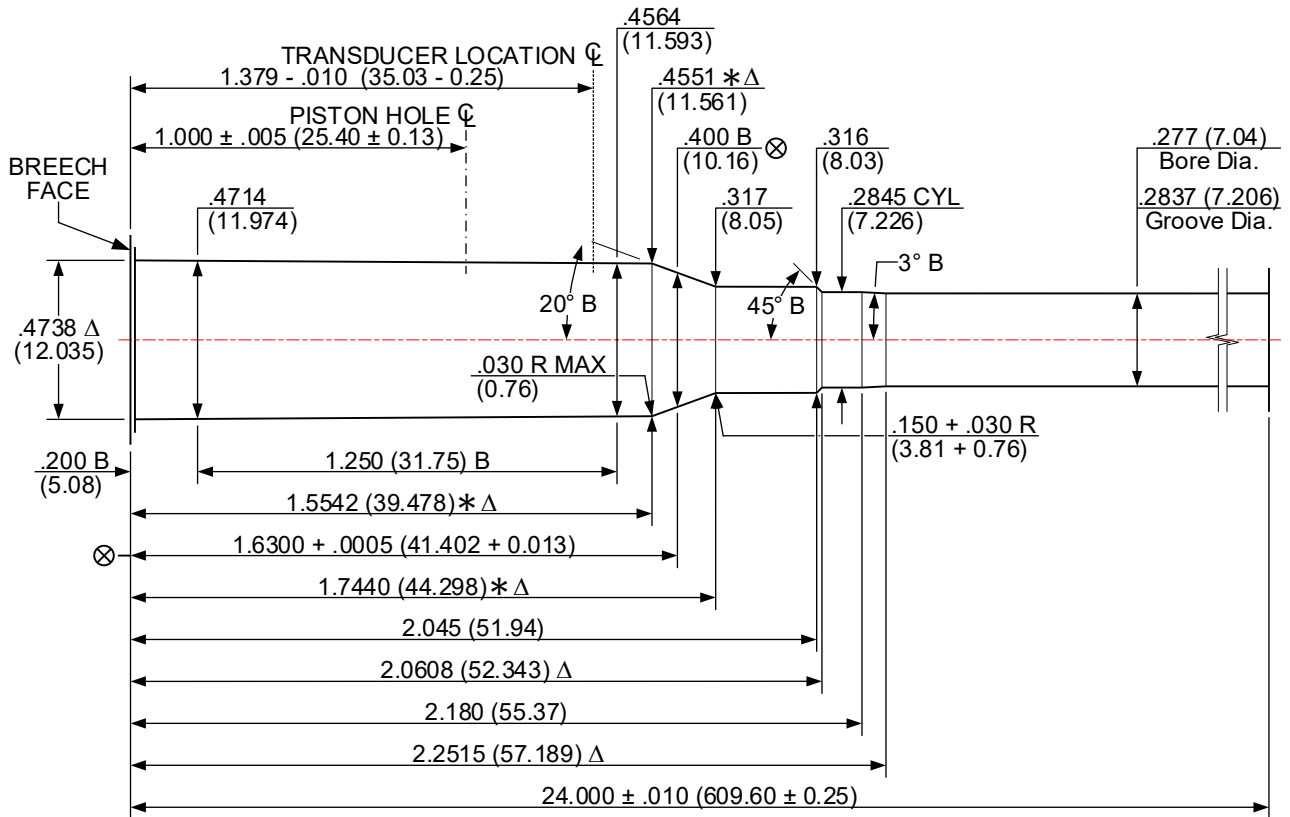

NUMBER OF GROOVES: 6
 WIDTH OF GROOVES: .110 + .002 (2.79 + 0.05)
 TWIST RATE: 9.50 (241.3) R.H.
 DIAMETER OF PISTON HOLE: .206 (5.23)
 TRANSDUCER DIAMETER: .250 (6.35)

LAND AND GROOVE DIMENSIONS TO BE
 WITHIN TOLERANCES THROUGHOUT
 LENGTH OF BARREL.

UNLESS OTHERWISE NOTED,
 ALL DIAMETERS +.0005 (0.013)
 LENGTH TOLERANCE + .005 (0.13)

DO NOT SCALE FROM DRAWING

NOTES:

B = BASIC

Δ = REFERENCE DIMENSION

⊗ = HEADSPACE DIMENSION

* DIMENSIONS ARE TO INTERSECTIONS OF LINES

(XX.XX) = MILLIMETERS

ALL CALCULATIONS APPLY AT MAXIMUM MATERIAL CONDITION (MMC)

7 X 64 BRENNEKE [7 X 64]

ISSUED: 07/28/1993 V&P TEST BARREL REVISED: 10/24/2022

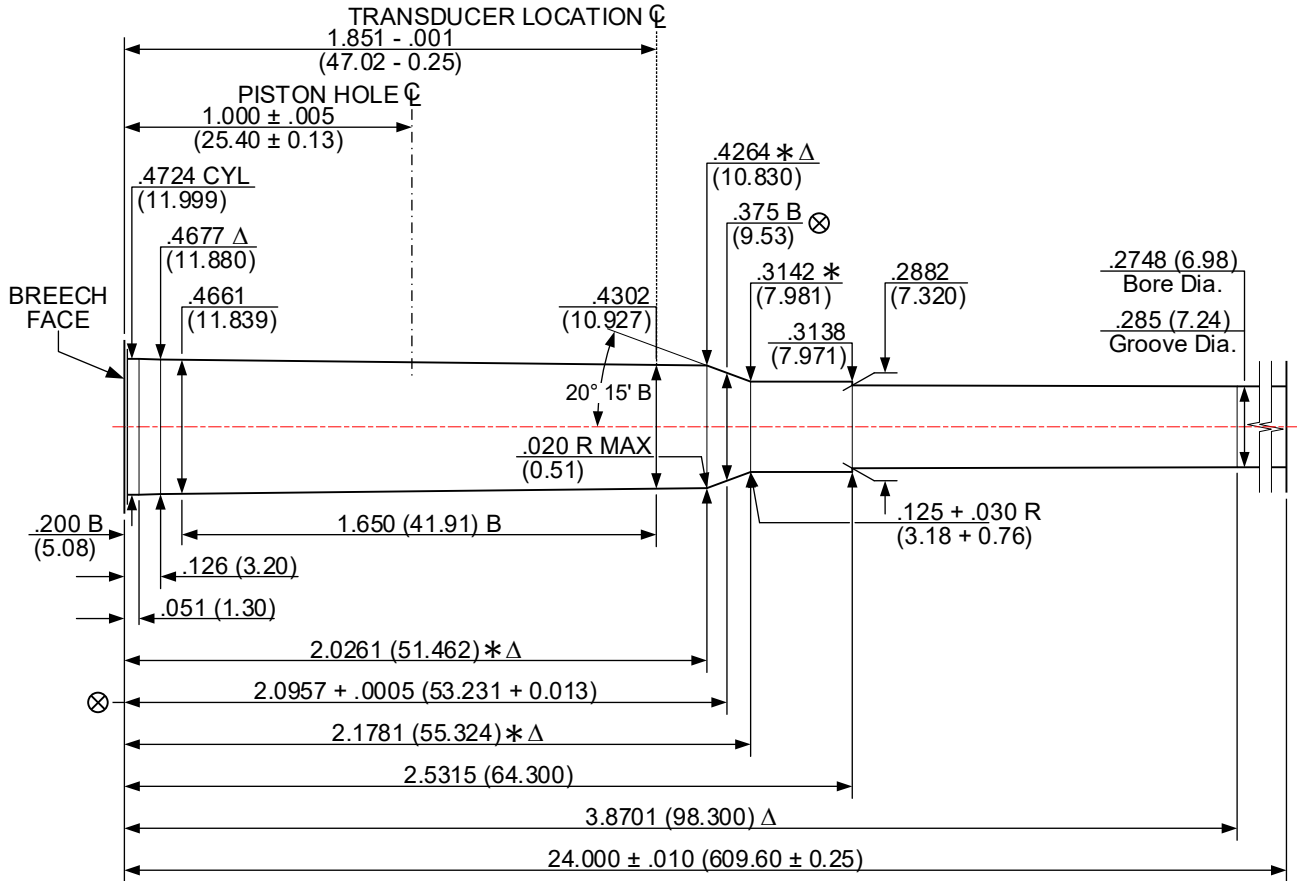

NUMBER OF GROOVES: 4
 WIDTH OF GROOVES: .146 + .002 (9.71 + 0.05)
 TWIST RATE: 8.661 (219.99) R.H.
 DIAMETER OF PISTON HOLE: .206 (5.23)
 TRANSDUCER DIAMETER: .250 (6.35)

LAND AND GROOVE DIMENSIONS TO BE
 WITHIN TOLERANCES THROUGHOUT
 LENGTH OF BARREL.

UNLESS OTHERWISE NOTED,
 ALL DIAMETERS +.0005 (0.013)
 LENGTH TOLERANCE + .005 (0.13)

DO NOT SCALE FROM DRAWING

NOTES:
 B = BASIC Δ = REFERENCE DIMENSION ⊗ = HEADSPACE DIMENSION
 * DIMENSIONS ARE TO INTERSECTIONS OF LINES (XX.XX) = MILLIMETERS
 ALL CALCULATIONS APPLY AT MAXIMUM MATERIAL CONDITION (MMC)

7.62 x 39 [7.69 X 39]
ISSUED: 08/01/1988 **V&P TEST BARREL** **REVISED: 10/24/2022**

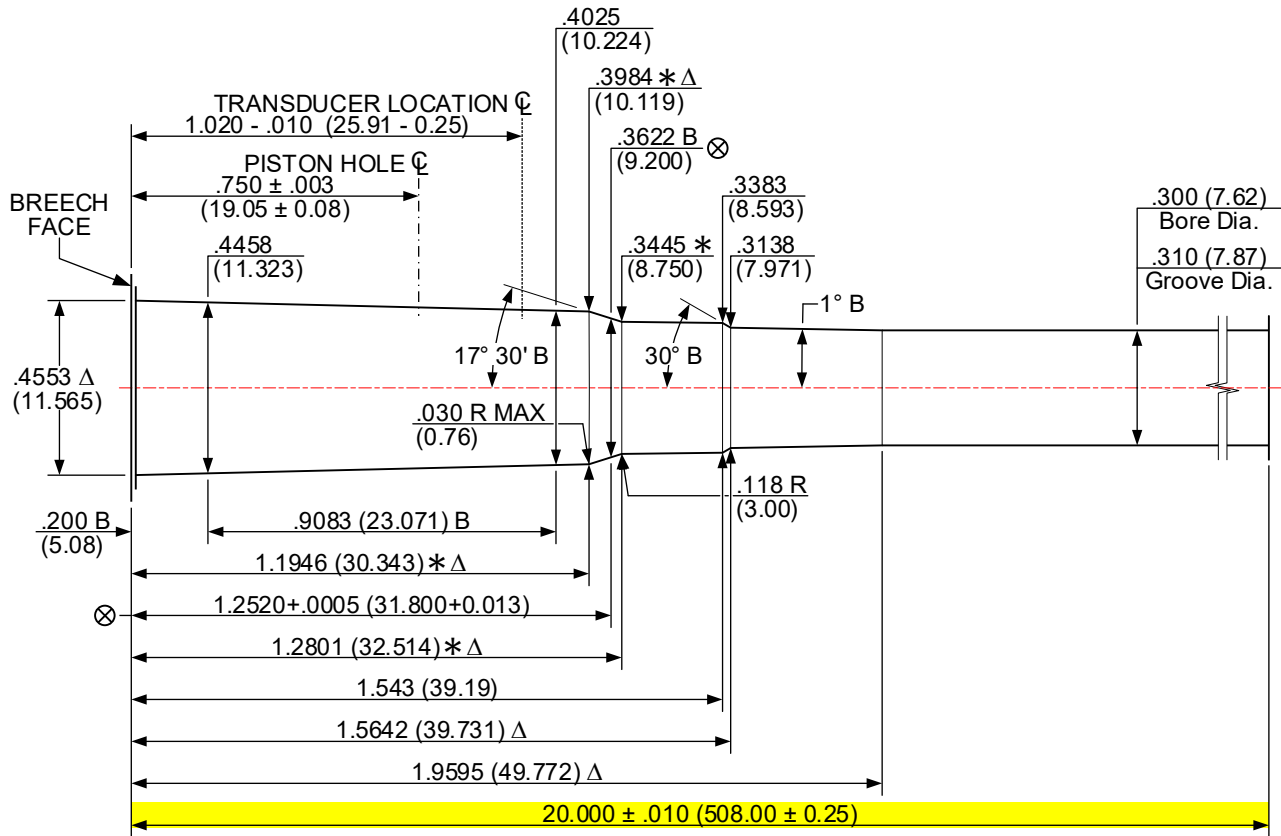

NUMBER OF GROOVES: 4
 WIDTH OF GROOVES: .150 + .002 (3.81 + 0.05)
 TWIST RATE: 9.45 (240.0) R.H.
 DIAMETER OF PISTON HOLE: .206 (5.23)
 TRANSDUCER DIAMETER: .250 (6.35)

LAND AND GROOVE DIMENSIONS TO BE
 WITHIN TOLERANCES THROUGHOUT
 LENGTH OF BARREL.

UNLESS OTHERWISE NOTED,
 ALL DIAMETERS +.0005 (0.013)
 LENGTH TOLERANCE + .005 (0.13)

DO NOT SCALE FROM DRAWING

NOTES:
 B = BASIC Δ = REFERENCE DIMENSION ⊗ = HEADSPACE DIMENSION
 * DIMENSIONS ARE TO INTERSECTIONS OF LINES (XX.XX) = MILLIMETERS
 ALL CALCULATIONS APPLY AT MAXIMUM MATERIAL CONDITION (MMC)

8MM MAUSER (8 x 57) [8MM (8 X 57)]
 ISSUED: 05/20/1980 V&P TEST BARREL REVISED: 10/28/2022

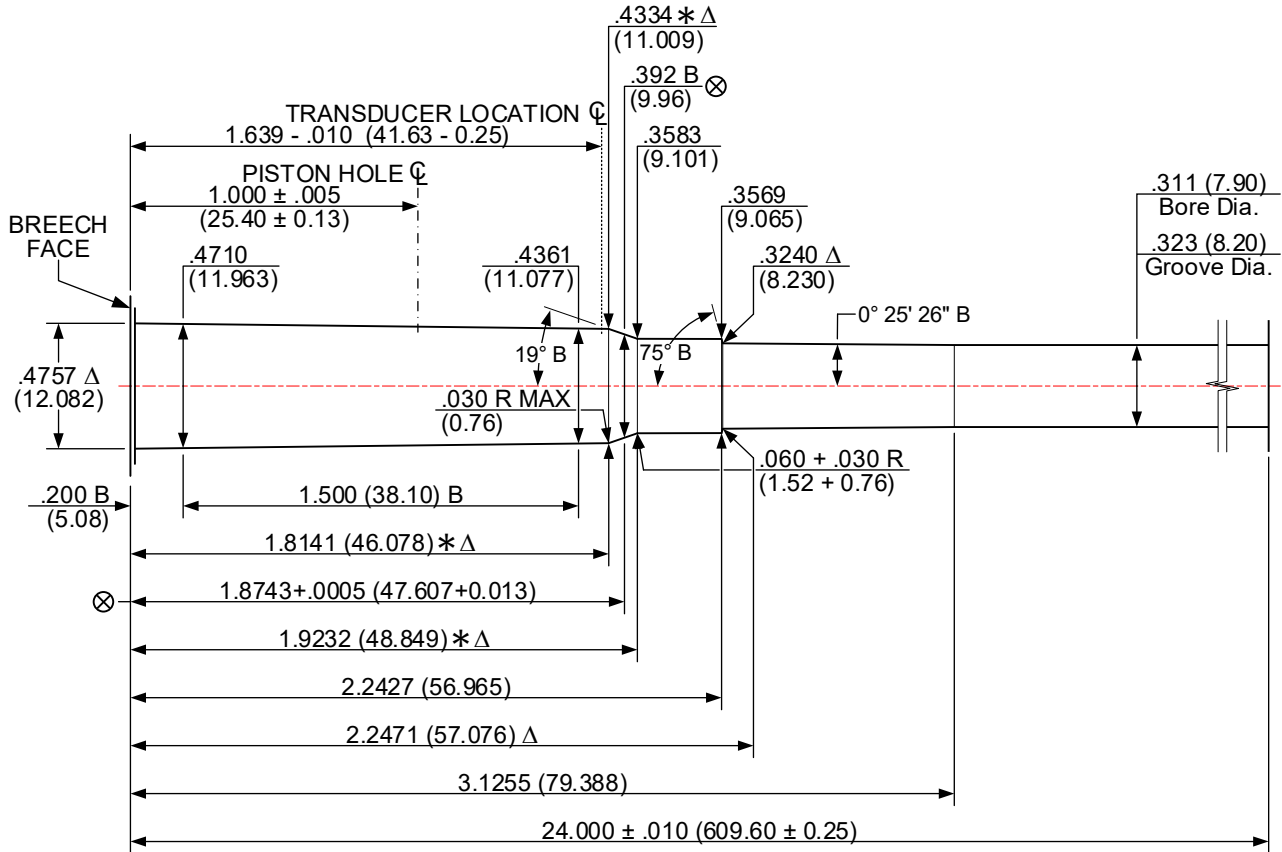

NUMBER OF GROOVES: 4
 WIDTH OF GROOVES: .176 + .002 (4.47 + 0.05)
 TWIST RATE: 9.5 (241.3) R.H.
 DIAMETER OF PISTON HOLE: .206 (5.23)
 TRANSDUCER DIAMETER: .250 (6.35)

LAND AND GROOVE DIMENSIONS TO BE
 WITHIN TOLERANCES THROUGHOUT
 LENGTH OF BARREL.

UNLESS OTHERWISE NOTED,
 ALL DIAMETERS +.0005 (0.013)
 LENGTH TOLERANCE + .005 (0.13)

DO NOT SCALE FROM DRAWING

NOTES:

B = BASIC

Δ = REFERENCE DIMENSION

⊗ = HEADSPACE DIMENSION

* DIMENSIONS ARE TO INTERSECTIONS OF LINES

(XX.XX) = MILLIMETERS

ALL CALCULATIONS APPLY AT MAXIMUM MATERIAL CONDITION (MMC)

9.3 x 62 [9.3 x 62]
ISSUED: 01/15/2013 **V&P TEST BARREL** **REVISED: 11/07/2022**

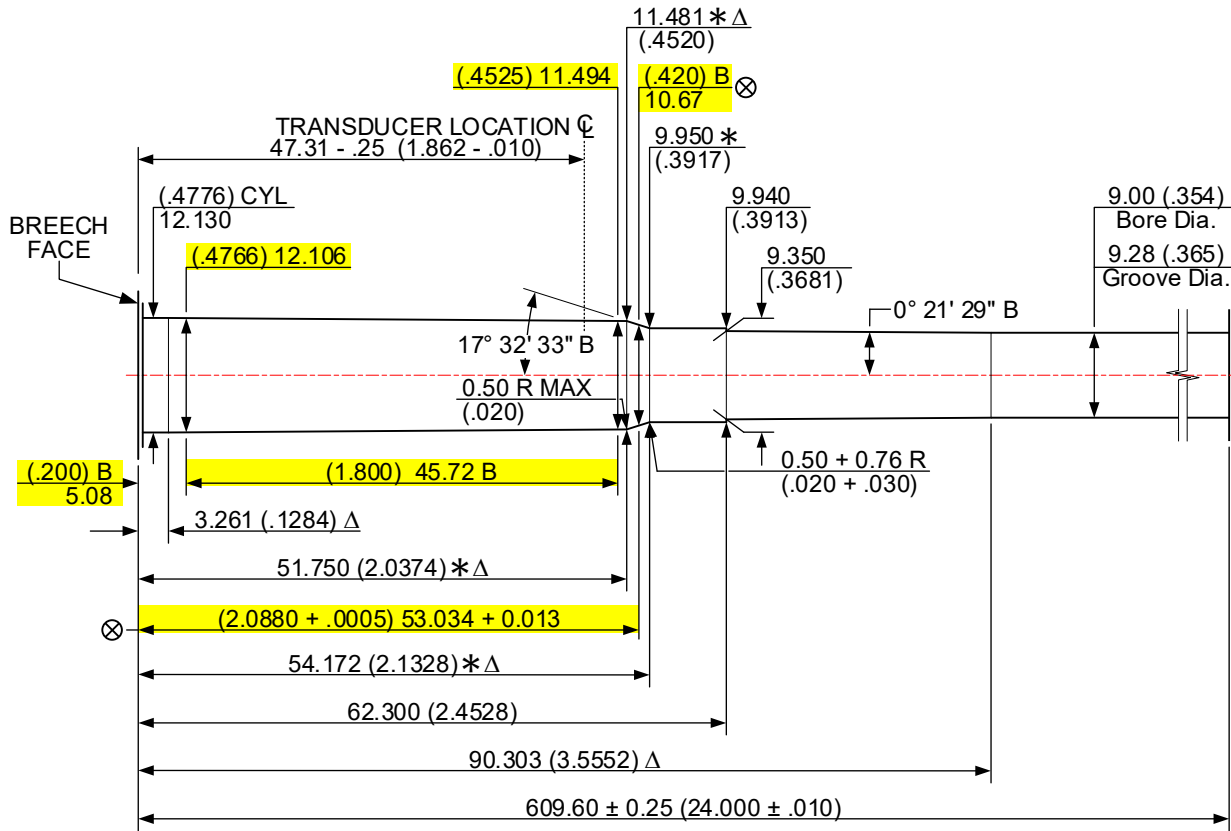

HIGHLIGHTED DIMENSIONS HAVE NO CORRESPONDING C.I.P. ANALOG. THE ENGLISH UNITS FOR THESE ARE THE ORIGINAL VALUES; METRIC VALUES ARE CALCULATED AND ROUNDED.

NUMBER OF GROOVES: 4
 WIDTH OF GROOVES: 4.60 + .05 (.181 + 0.002)
 TWIST RATE: 360.0 (14.17) R.H.
 DIAMETER OF PISTON HOLE: Crusher pressure not established.
 TRANSDUCER DIAMETER: 6.35 (.250)

LAND AND GROOVE DIMENSIONS TO BE
 WITHIN TOLERANCES THROUGHOUT
 LENGTH OF BARREL.

UNLESS OTHERWISE NOTED,
 ALL DIAMETERS +.0005 (0.013)
 LENGTH TOLERANCE + .005 (0.13)

DO NOT SCALE FROM DRAWING

NOTES:

- B = BASIC
- * DIMENSIONS ARE TO INTERSECTIONS OF LINES
- ALL CALCULATIONS APPLY AT MAXIMUM MATERIAL CONDITION (MMC)
- Δ = REFERENCE DIMENSION
- \otimes = HEADSPACE DIMENSION
- (XX.XX) = MILLIMETERS

17 HORNET [17 HORNET]
 ISSUED: 06/06/2012 V&P TEST BARREL REVISED: 11/07/2022

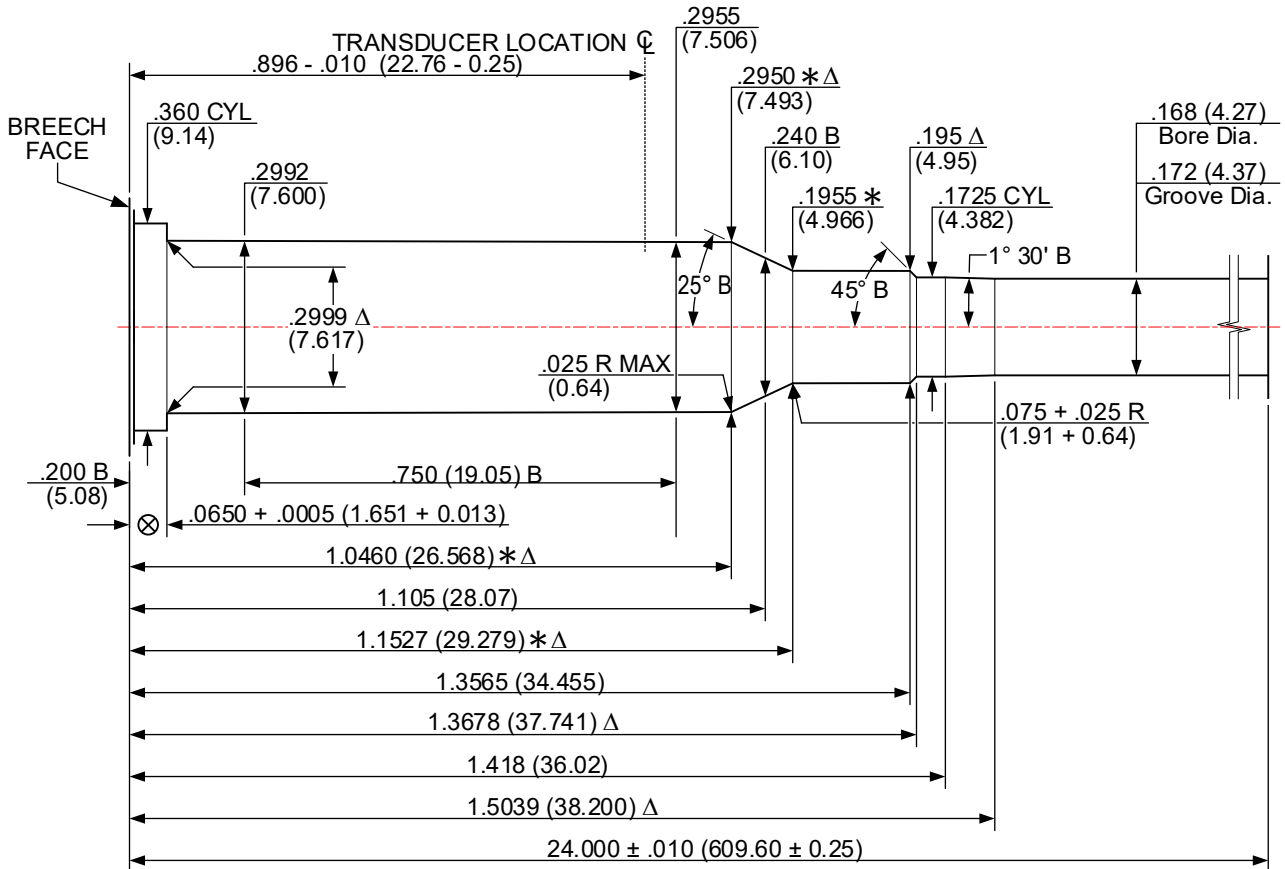

NUMBER OF GROOVES: 6
 WIDTH OF GROOVES: .062 + .002 (1.58 + 0.05)
 TWIST RATE: 9.00 (228.6) R.H.
 DIAMETER OF PISTON HOLE: Crusher Pressures Not Established
TRANSDUCER DIAMETER: .194 (4.93)

LAND AND GROOVE DIMENSIONS TO BE
 WITHIN TOLERANCES THROUGHOUT
 LENGTH OF BARREL.

UNLESS OTHERWISE NOTED,
 ALL DIAMETERS +.0005 (0.013)
 LENGTH TOLERANCE + .005 (0.13)

DO NOT SCALE FROM DRAWING

NOTES:
 B = BASIC Δ = REFERENCE DIMENSION ⊗ = HEADSPACE DIMENSION
 * DIMENSIONS ARE TO INTERSECTIONS OF LINES (XX.XX) = MILLIMETERS
 ALL CALCULATIONS APPLY AT MAXIMUM MATERIAL CONDITION (MMC)

NOTICE: This drawing is subject to change.
 Revisions, if applicable, are available at www.saami.org.

17 REMINGTON [17 REM]
V&P TEST BARREL REVISED: 11/07/2022

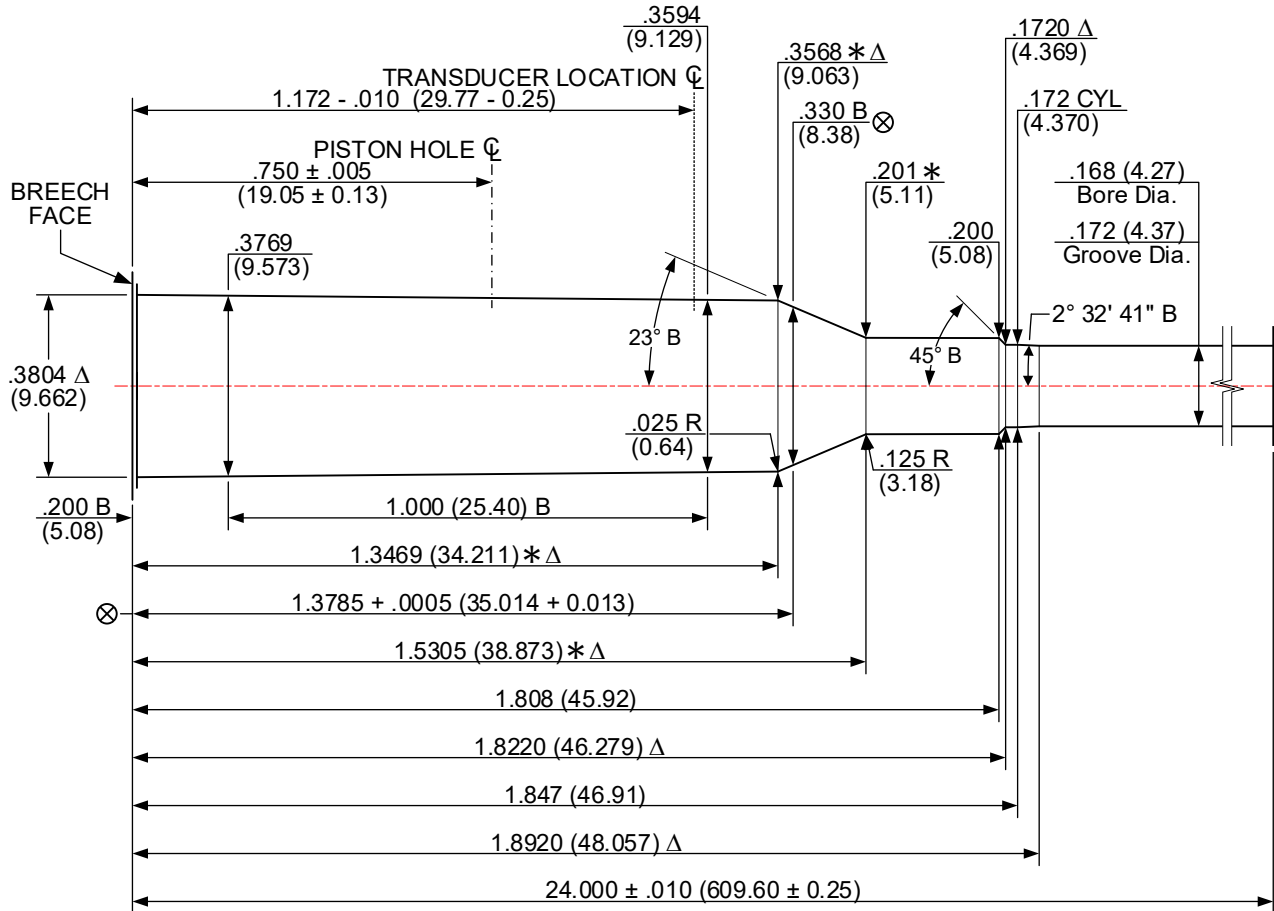

NUMBER OF GROOVES: 6
 WIDTH OF GROOVES: $.062 + .002$ (1.57 + 0.05)
 TWIST RATE: 9.00 (228.6) R.H.
 DIAMETER OF PISTON HOLE: $.206$ (5.23)
 TRANSDUCER DIAMETER: $.250$ (6.35)

LAND AND GROOVE DIMENSIONS TO BE
 WITHIN TOLERANCES THROUGHOUT
 LENGTH OF BARREL.

UNLESS OTHERWISE NOTED,
 ALL DIAMETERS $+ .0005$ (0.013)
 LENGTH TOLERANCE $+ .005$ (0.13)

DO NOT SCALE FROM DRAWING

NOTES:

B = BASIC

Δ = REFERENCE DIMENSION

\otimes = HEADSPACE DIMENSION

* DIMENSIONS ARE TO INTERSECTIONS OF LINES

(XX.XX) = MILLIMETERS

ALL CALCULATIONS APPLY AT MAXIMUM MATERIAL CONDITION (MMC)

17 REMINGTON FIREBALL [17 REM FB]
 ISSUED: 01/04/2007 V&P TEST BARREL REVISED: 11/09/2022

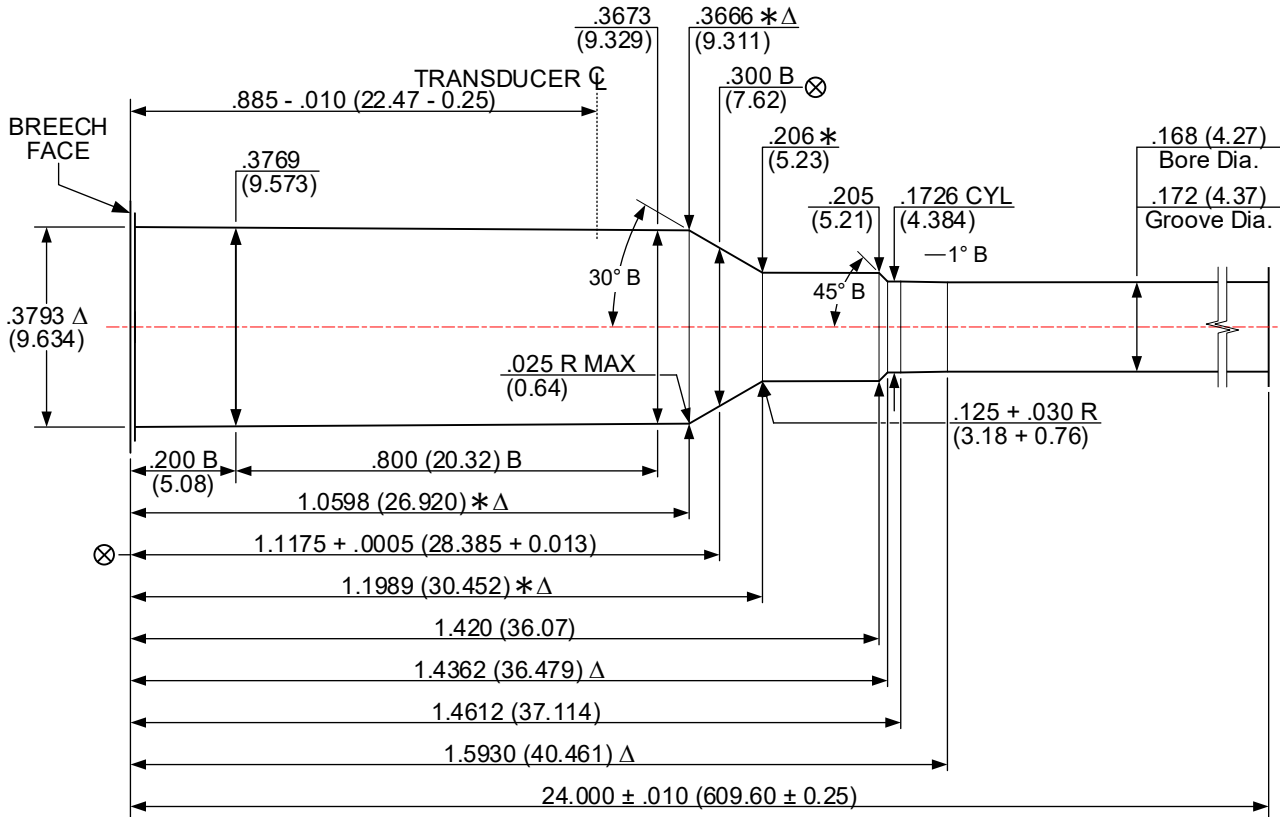

NUMBER OF GROOVES: 6
 WIDTH OF GROOVES: .062 + .002 (1.57 + 0.05)
 TWIST RATE: 9.00 (228.6) R.H.
 DIAMETER OF PISTON HOLE: Crusher pressures not established.
 TRANSDUCER DIAMETER: .250 (6.35)

LAND AND GROOVE DIMENSIONS TO BE
 WITHIN TOLERANCES THROUGHOUT
 LENGTH OF BARREL.

UNLESS OTHERWISE NOTED,
 ALL DIAMETERS +.0005 (0.013)
 LENGTH TOLERANCE + .005 (0.13)

DO NOT SCALE FROM DRAWING

NOTES:
 B = BASIC Δ = REFERENCE DIMENSION ⊗ = HEADSPACE DIMENSION
 * DIMENSIONS ARE TO INTERSECTIONS OF LINES (XX.XX) = MILLIMETERS
 ALL CALCULATIONS APPLY AT MAXIMUM MATERIAL CONDITION (MMC)

204 RUGER [204 RUGER]
 ISSUED: 06/12/2004 V&P TEST BARREL REVISED: 08/04/2023

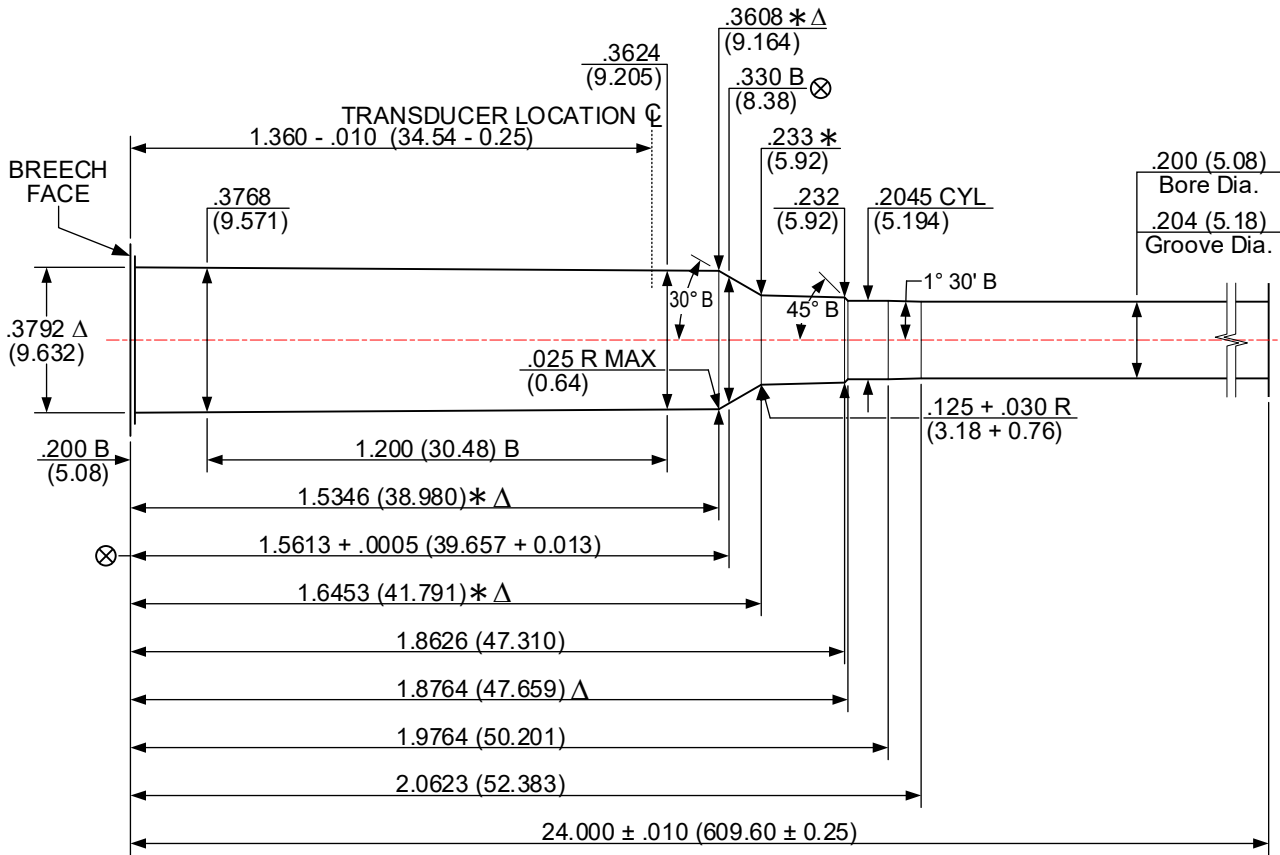

NUMBER OF GROOVES: 6
 WIDTH OF GROOVES: .054 + .002 (1.37 + 0.05)
 TWIST RATE: 12.00 (304.8) R.H.
 DIAMETER OF PISTON HOLE: Crusher pressures not established
 TRANSDUCER DIAMETER: .250 (6.35)

LAND AND GROOVE DIMENSIONS TO BE
 WITHIN TOLERANCES THROUGHOUT
 LENGTH OF BARREL.

UNLESS OTHERWISE NOTED,
 ALL DIAMETERS +.0005 (0.013)
 LENGTH TOLERANCE + .005 (0.13)

DO NOT SCALE FROM DRAWING

NOTES:
 B = BASIC Δ = REFERENCE DIMENSION ⊗ = HEADSPACE DIMENSION
 * DIMENSIONS ARE TO INTERSECTIONS OF LINES (XX.XX) = MILLIMETERS
 ALL CALCULATIONS APPLY AT MAXIMUM MATERIAL CONDITION (MMC)

218 BEE [218 BEE]
V&P TEST BARREL

ISSUED: 05/20/1980

REVISED: 11/10/2022

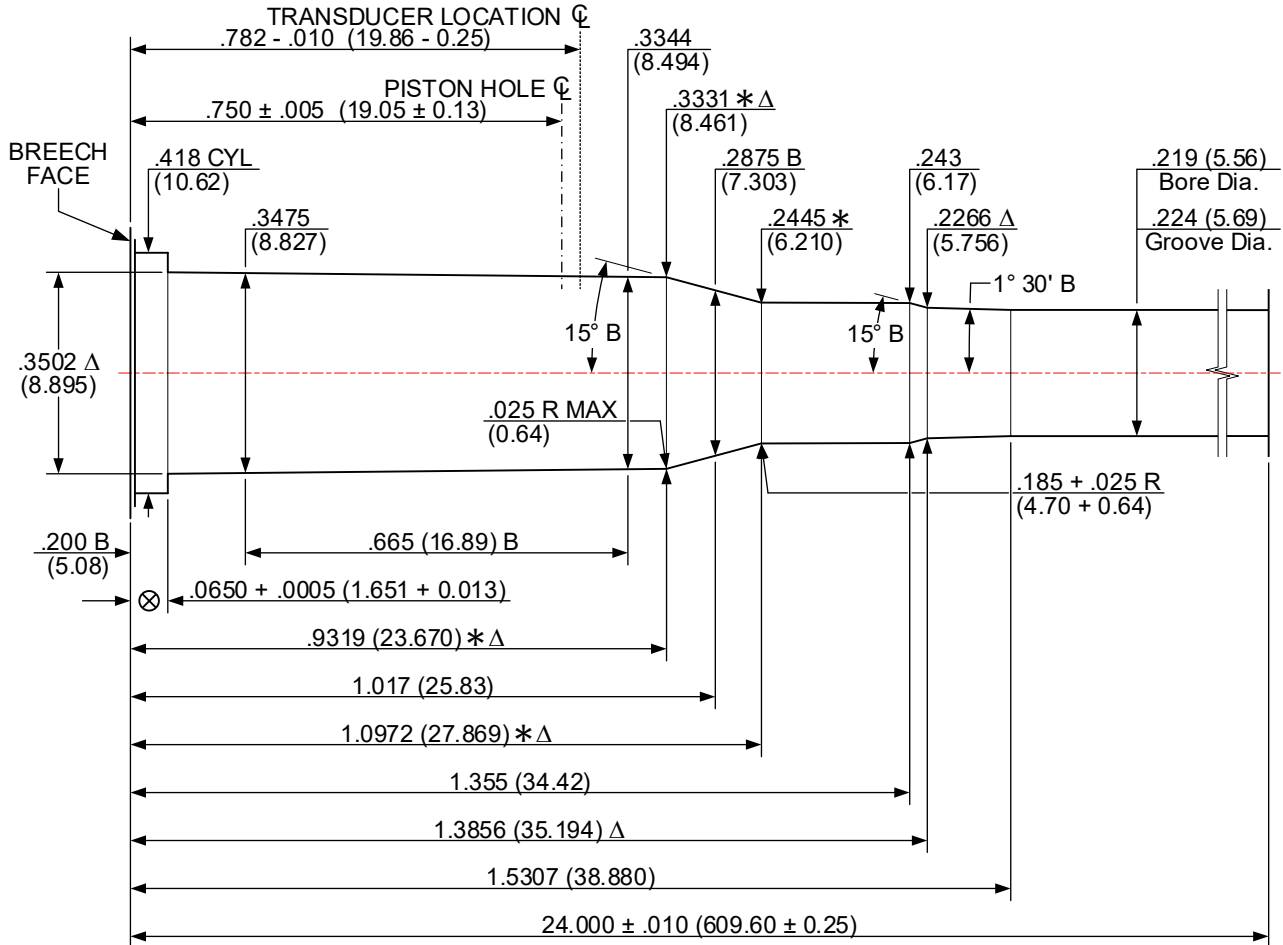

NUMBER OF GROOVES: 6
 WIDTH OF GROOVES: $.074 + .002$ (1.88 + 0.05)
 TWIST RATE: 16.00 (406.4) R.H.
 DIAMETER OF PISTON HOLE: $.206$ (5.23)
TRANSDUCER DIAMETER: $.194$ (4.93)

LAND AND GROOVE DIMENSIONS TO BE
 WITHIN TOLERANCES THROUGHOUT
 LENGTH OF BARREL.

UNLESS OTHERWISE NOTED,
 ALL DIAMETERS $+0.005$ (0.013)
 LENGTH TOLERANCE $+ .005$ (0.13)

DO NOT SCALE FROM DRAWING

NOTES:

B = BASIC

Δ = REFERENCE DIMENSION

\otimes = HEADSPACE DIMENSION

* DIMENSIONS ARE TO INTERSECTIONS OF LINES

(XX.XX) = MILLIMETERS

ALL CALCULATIONS APPLY AT MAXIMUM MATERIAL CONDITION (MMC)

22 ADVANCED RIFLE CARTRIDGE [22 ARC]

ISSUED: 01/21/2024 V&P TEST BARREL REVISED: - / - / - - -

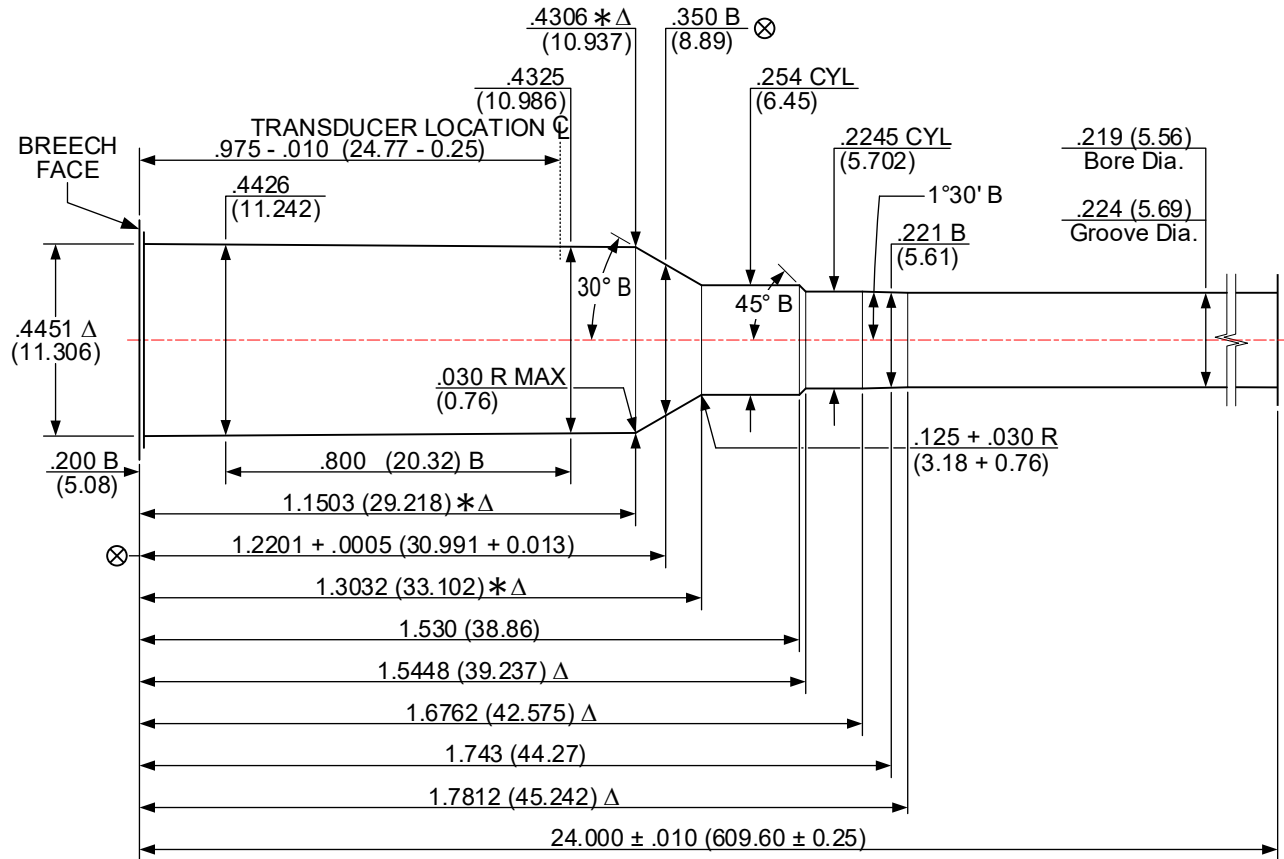

NUMBER OF GROOVES: 6
 WIDTH OF GROOVES: .074 + .002 (1.88 + 0.05)
 TWIST RATE: 7.00 (177.8) R.H.
 DIAMETER OF PISTON HOLE: Crusher pressures not established
 TRANSDUCER DIAMETER: .250 (6.35)

LAND AND GROOVE DIMENSIONS TO BE
 WITHIN TOLERANCES THROUGHOUT
 LENGTH OF BARREL.

UNLESS OTHERWISE NOTED,
 ALL DIAMETERS +.0005 (0.013)
 LENGTH TOLERANCE + .005 (0.13)

DO NOT SCALE FROM DRAWING

NOTE:

B = BASIC Δ = REFERENCE DIMENSION ⊗ = HEADSPACE DIMENSION
 * DIMENSIONS ARE TO INTERSECTIONS OF LINES (XX.XX) = MILLIMETERS
 ALL CALCULATIONS APPLY AT MAXIMUM MATERIAL CONDITION (MMC)

22 CREEDMOOR [22 CM]

V&P TEST BARREL

ISSUED: 01/21/2024 REVISED: - / - / - - -

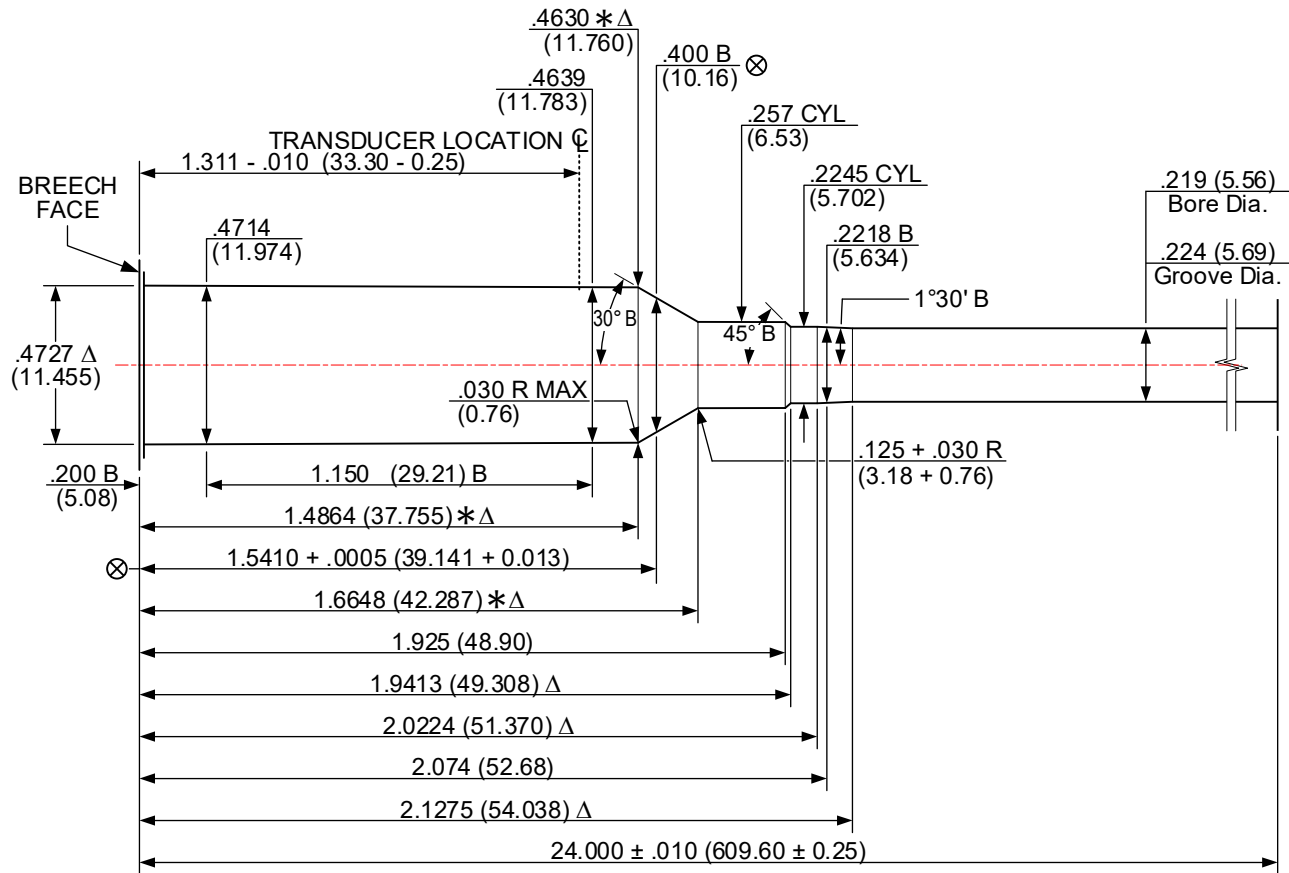

NUMBER OF GROOVES: 6

WIDTH OF GROOVES: .074 + .002 (1.88 + 0.05)

TWIST RATE: 8.00 (203.2) R.H.

DIAMETER OF PISTON HOLE: Crusher pressures not established

TRANSDUCER DIAMETER: .250 (6.35)

LAND AND GROOVE DIMENSIONS TO BE
 WITHIN TOLERANCES THROUGHOUT
 LENGTH OF BARREL.

UNLESS OTHERWISE NOTED,
 ALL DIAMETERS +.0005 (0.013)
 LENGTH TOLERANCE + .005 (0.13)

DO NOT SCALE FROM DRAWING

NOTE:

B = BASIC

Δ = REFERENCE DIMENSION

⊗ = HEADSPACE DIMENSION

* DIMENSIONS ARE TO INTERSECTIONS OF LINES

(XX.XX) = MILLIMETERS

ALL CALCULATIONS APPLY AT MAXIMUM MATERIAL CONDITION (MMC)

22 HORNET [22 HORNET]
 ISSUED: 05/20/1980 V&P TEST BARREL REVISED: 11/10/2022

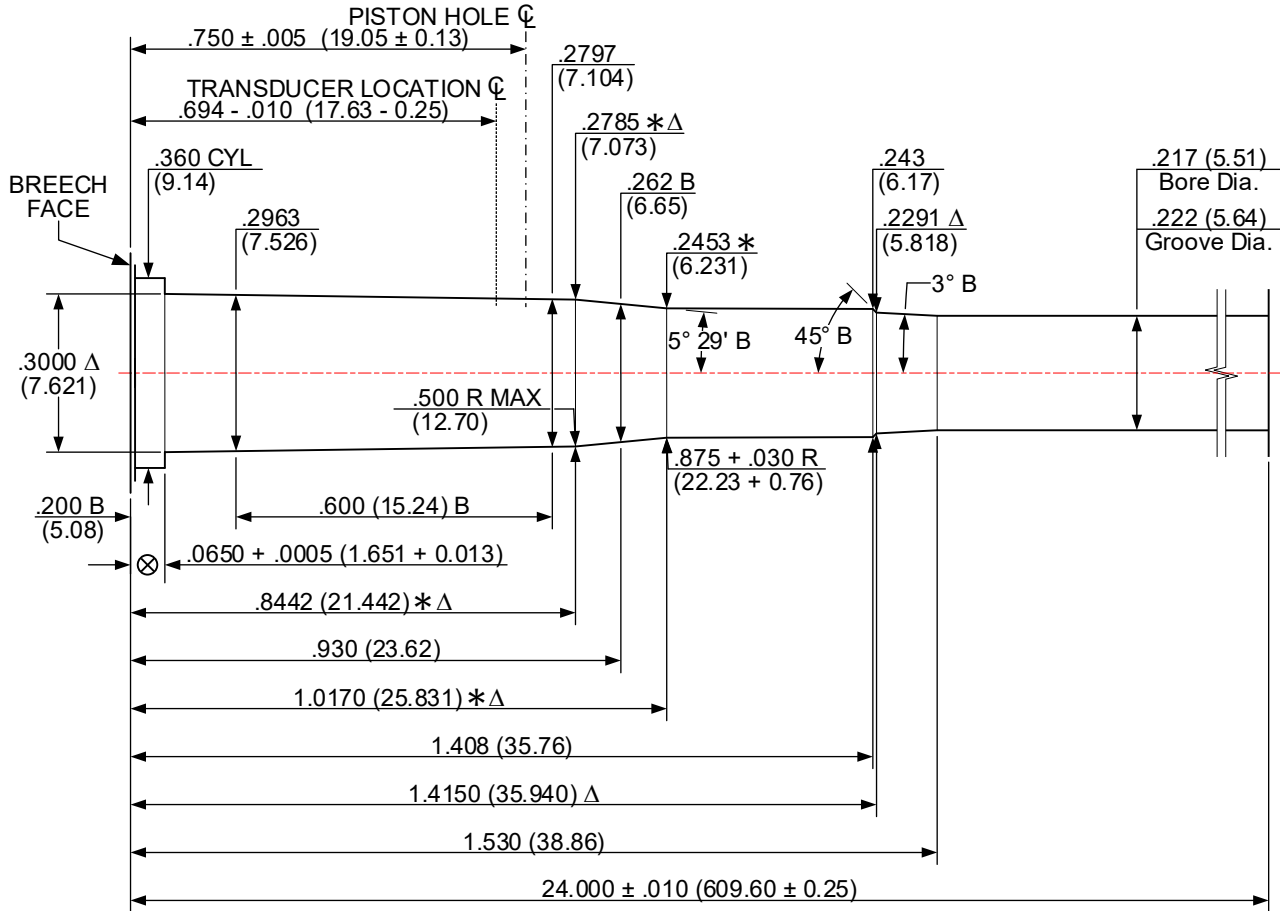

NUMBER OF GROOVES: 6
 WIDTH OF GROOVES: .068 + .002 (1.73 + 0.05)
 TWIST RATE: 16.00 (406.4) R.H.
 DIAMETER OF PISTON HOLE: .206 (5.23)
TRANSDUCER DIAMETER: .194 (4.93)

LAND AND GROOVE DIMENSIONS TO BE
 WITHIN TOLERANCES THROUGHOUT
 LENGTH OF BARREL.

UNLESS OTHERWISE NOTED,
 ALL DIAMETERS +.0005 (0.013)
 LENGTH TOLERANCE + .005 (0.13)

DO NOT SCALE FROM DRAWING

NOTES:

B = BASIC

Δ = REFERENCE DIMENSION

⊗ = HEADSPACE DIMENSION

* DIMENSIONS ARE TO INTERSECTIONS OF LINES

(XX.XX) = MILLIMETERS

ALL CALCULATIONS APPLY AT MAXIMUM MATERIAL CONDITION (MMC)

22 Nosler [22 NOSLER]
 ISSUED: 01/16/2017 V&P TEST BARREL REVISED: 12/06/2022

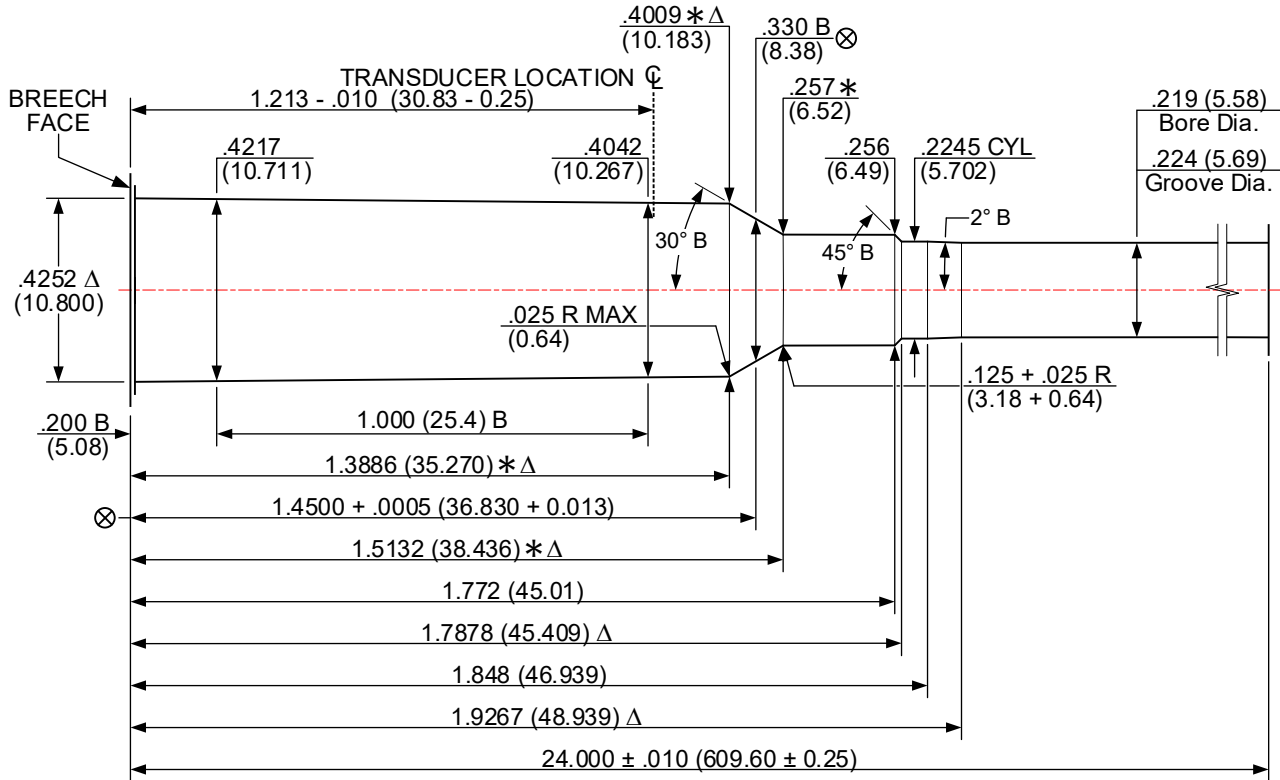

NUMBER OF GROOVES: 6
 WIDTH OF GROOVES: .074 + .002 (1.88 + 0.05)
 TWIST RATE: 8.00 (203.2) R.H.
 DIAMETER OF PISTON HOLE: Crusher pressures not established
 TRANSDUCER DIAMETER: .250 (6.35)

LAND AND GROOVE DIMENSIONS TO BE
 WITHIN TOLERANCES THROUGHOUT
 LENGTH OF BARREL.

UNLESS OTHERWISE NOTED,
 ALL DIAMETERS +.0005 (0.013)
 LENGTH TOLERANCE + .005 (0.13)

DO NOT SCALE FROM DRAWING

NOTES:
 B = BASIC Δ = REFERENCE DIMENSION ⊗ = HEADSPACE DIMENSION
 * DIMENSIONS ARE TO INTERSECTIONS OF LINES (XX.XX) = MILLIMETERS
 ALL CALCULATIONS APPLY AT MAXIMUM MATERIAL CONDITION (MMC)

220 SWIFT [220 SWIFT]
V&P TEST BARREL

ISSUED: 05/20/1980

REVISED: 03/24/2023

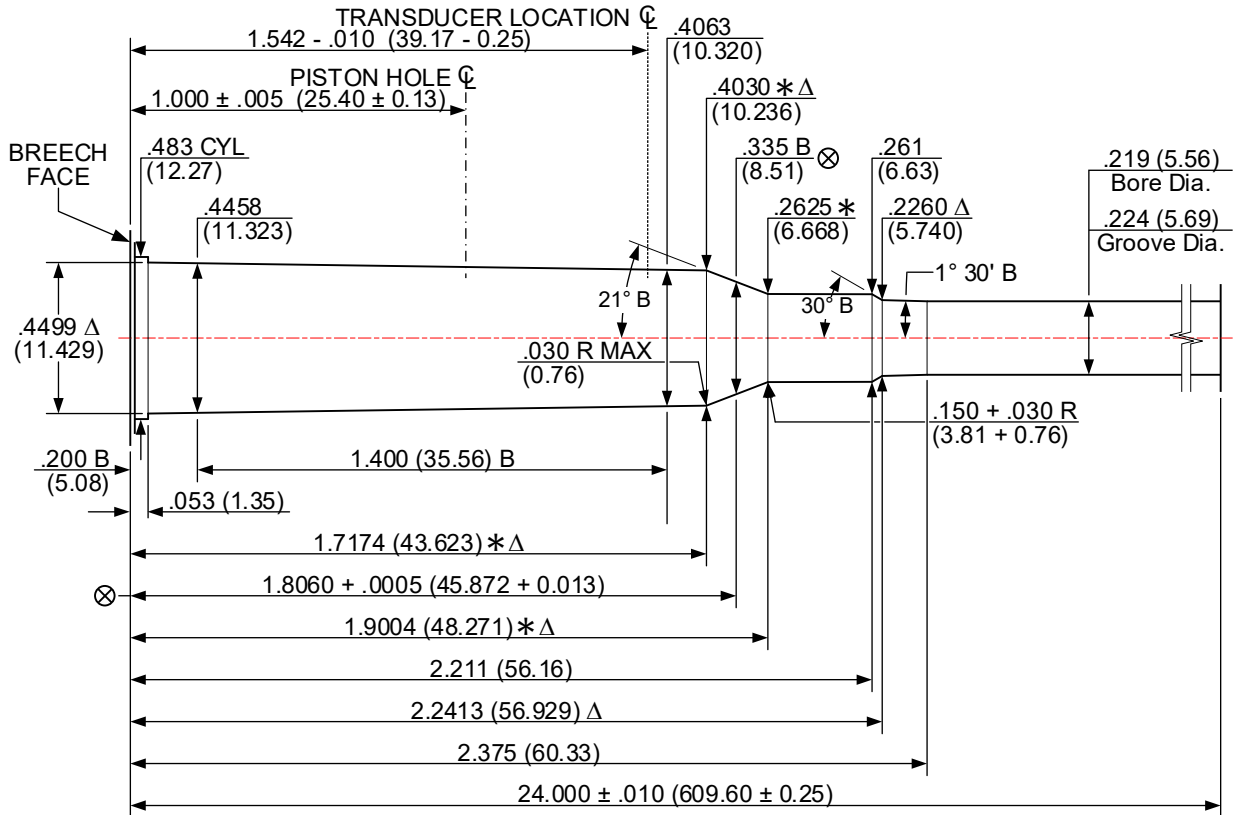

NUMBER OF GROOVES: 6
 WIDTH OF GROOVES: .074 + .002 (1.88 + 0.05)
 TWIST RATE: 14.00 (355.6) R.H.
 DIAMETER OF PISTON HOLE: .206 (5.23)
 TRANSDUCER DIAMETER: .250 (6.35)

LAND AND GROOVE DIMENSIONS TO BE
 WITHIN TOLERANCES THROUGHOUT
 LENGTH OF BARREL.

UNLESS OTHERWISE NOTED,
 ALL DIAMETERS +.0005 (0.013)
 LENGTH TOLERANCE + .005 (0.13)

DO NOT SCALE FROM DRAWING

NOTE:

B = BASIC

Δ = REFERENCE DIMENSION

⊗ = HEADSPACE DIMENSION

* DIMENSIONS ARE TO INTERSECTIONS OF LINES

(XX.XX) = MILLIMETERS

ALL CALCULATIONS APPLY AT MAXIMUM MATERIAL CONDITION (MMC)

221 REMINGTON FIREBALL [221 REM FB]
 ISSUED: 01/16/2005 RIFLE V&P TEST BARREL REVISED: 06/27/2023

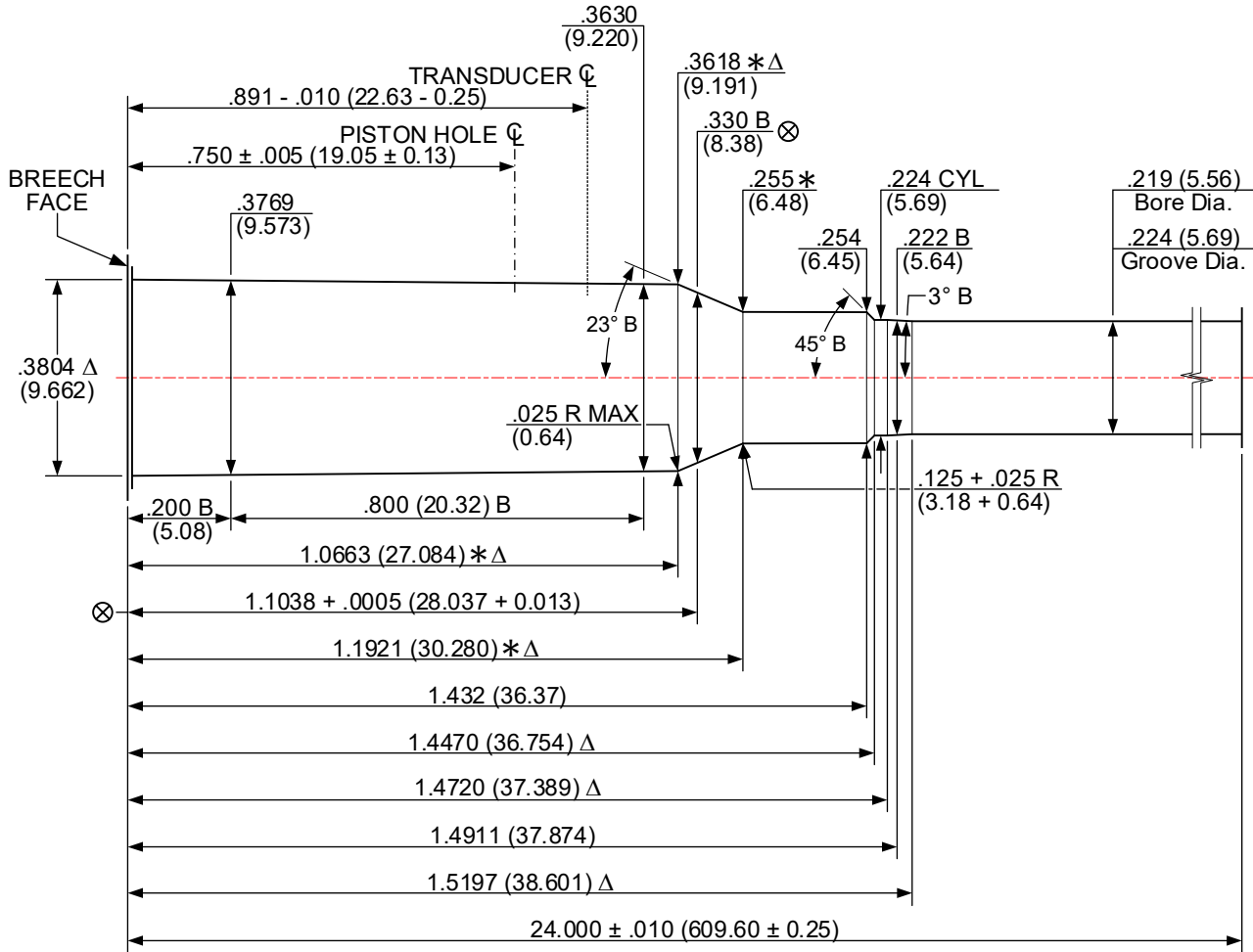

NUMBER OF GROOVES: 6
 WIDTH OF GROOVES: .080 + .002 (2.03 + 0.05)
 TWIST RATE: 14.00 (355.6) R.H.
 DIAMETER OF PISTON HOLE: .206 (5.23)
 TRANSDUCER DIAMETER: .250 (6.35)

LAND AND GROOVE DIMENSIONS TO BE
 WITHIN TOLERANCES THROUGHOUT
 LENGTH OF BARREL.

UNLESS OTHERWISE NOTED,
 ALL DIAMETERS +.0005 (0.013)
 LENGTH TOLERANCE + .005 (0.13)

DO NOT SCALE FROM DRAWING

NOTES:
 B = BASIC Δ = REFERENCE DIMENSION ⊗ = HEADSPACE DIMENSION
 * DIMENSIONS ARE TO INTERSECTIONS OF LINES (XX.XX) = MILLIMETERS
 ALL CALCULATIONS APPLY AT MAXIMUM MATERIAL CONDITION (MMC)

222 REMINGTON [222 REM]
 ISSUED: 05/20/1980 V&P TEST BARREL REVISED: 06/28/2023

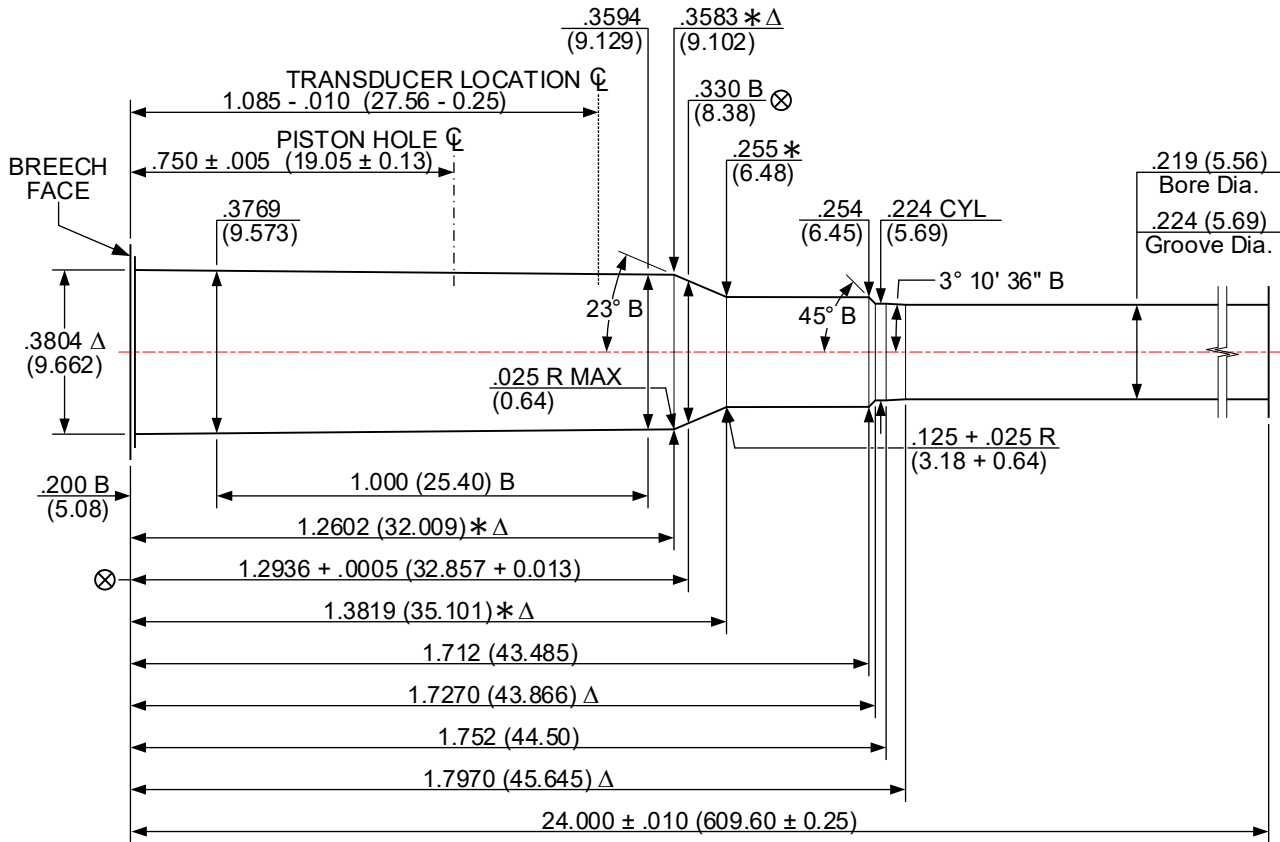

NUMBER OF GROOVES: 6
 WIDTH OF GROOVES: $.080 + .002$ (2.03 + 0.05)
 TWIST RATE: 14.00 (355.6) R.H.
 DIAMETER OF PISTON HOLE: $.206$ (5.23)
 TRANSDUCER DIAMETER: $.250$ (6.35)

LAND AND GROOVE DIMENSIONS TO BE
 WITHIN TOLERANCES THROUGHOUT
 LENGTH OF BARREL.

UNLESS OTHERWISE NOTED,
 ALL DIAMETERS $+ .0005$ (0.013)
 LENGTH TOLERANCE $+ .005$ (0.13)

DO NOT SCALE FROM DRAWING

NOTES:

B = BASIC

Δ = REFERENCE DIMENSION

\otimes = HEADSPACE DIMENSION

* DIMENSIONS ARE TO INTERSECTIONS OF LINES

(XX.XX) = MILLIMETERS

ALL CALCULATIONS APPLY AT MAXIMUM MATERIAL CONDITION (MMC)

222 REMINGTON MAGNUM [222 REM MAG]
 ISSUED: 05/20/1980 V&P TEST BARREL REVISED: 06/28/2023

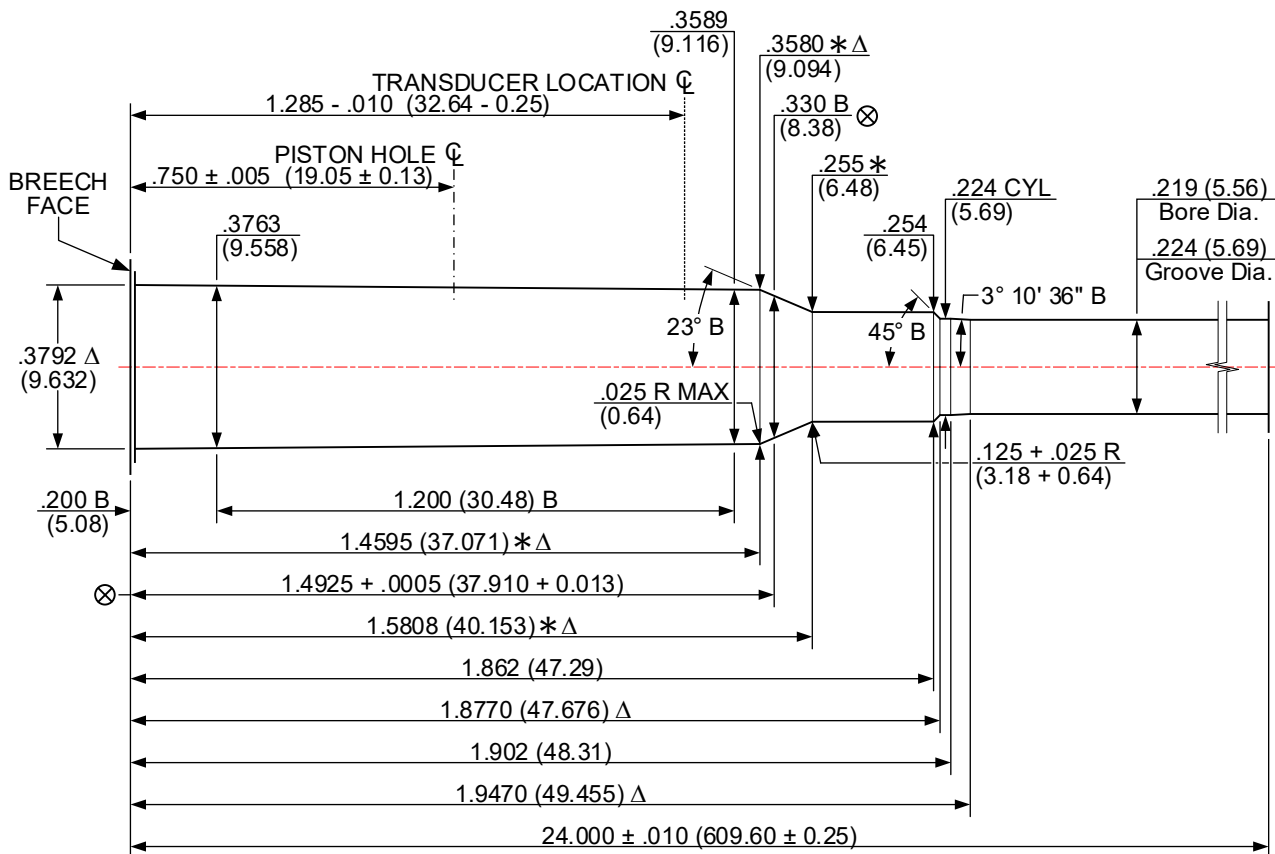

NUMBER OF GROOVES: 6
 WIDTH OF GROOVES: .080 + .002 (2.03 + 0.05)
 TWIST RATE: 14.00 (355.6) R.H.
 DIAMETER OF PISTON HOLE: .206 (5.23)
 TRANSDUCER DIAMETER: .250 (6.35)

LAND AND GROOVE DIMENSIONS TO BE
 WITHIN TOLERANCES THROUGHOUT
 LENGTH OF BARREL.

UNLESS OTHERWISE NOTED,
 ALL DIAMETERS +.0005 (0.013)
 LENGTH TOLERANCE + .005 (0.13)

DO NOT SCALE FROM DRAWING

NOTES:

- B = BASIC
- * DIMENSIONS ARE TO INTERSECTIONS OF LINES
- ALL CALCULATIONS APPLY AT MAXIMUM MATERIAL CONDITION (MMC)
- Δ = REFERENCE DIMENSION
- ⊗ = HEADSPACE DIMENSION
- (XX.XX) = MILLIMETERS

223 REMINGTON [223 REM]
 ISSUED: 05/20/1980 V&P TEST BARREL REVISED: 06/28/2023

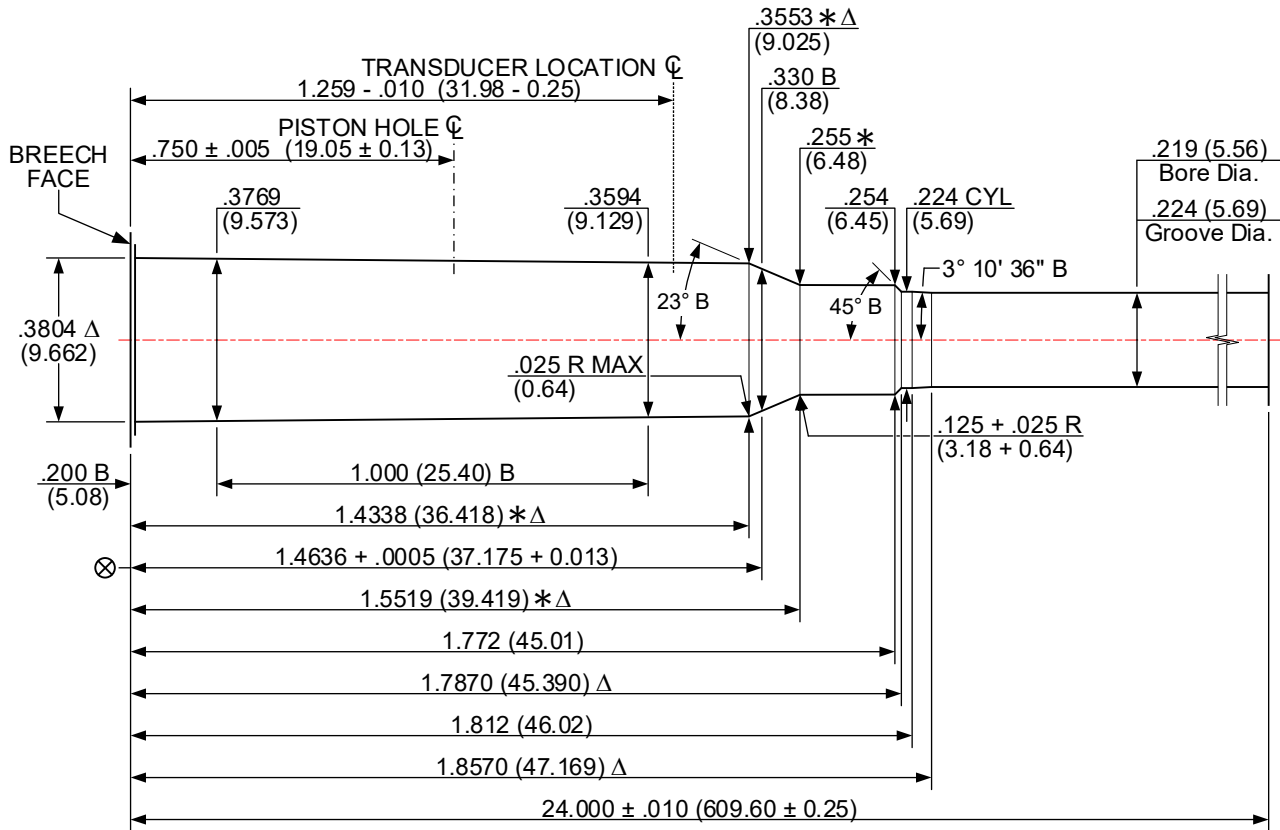

NUMBER OF GROOVES: 6
 WIDTH OF GROOVES: $.074 + .002$ (1.88 + 0.05)
 TWIST RATE: 12.00 (304.8) R.H.
 DIAMETER OF PISTON HOLE: $.206$ (5.23)
 TRANSDUCER DIAMETER: $.250$ (6.35)

LAND AND GROOVE DIMENSIONS TO BE
 WITHIN TOLERANCES THROUGHOUT
 LENGTH OF BARREL.

UNLESS OTHERWISE NOTED,
 ALL DIAMETERS $+ .0005$ (0.013)
 LENGTH TOLERANCE $+ .005$ (0.13)

DO NOT SCALE FROM DRAWING

NOTES:

B = BASIC

Δ = REFERENCE DIMENSION

⊗ = HEADSPACE DIMENSION

* DIMENSIONS ARE TO INTERSECTIONS OF LINES

(XX.XX) = MILLIMETERS

ALL CALCULATIONS APPLY AT MAXIMUM MATERIAL CONDITION (MMC)

223 WINCHESTER SUPER SHORT MAGNUM [223 WSSM]
 ISSUED: 05/31/2003 V&P TEST BARREL REVISED: 06/28/2023

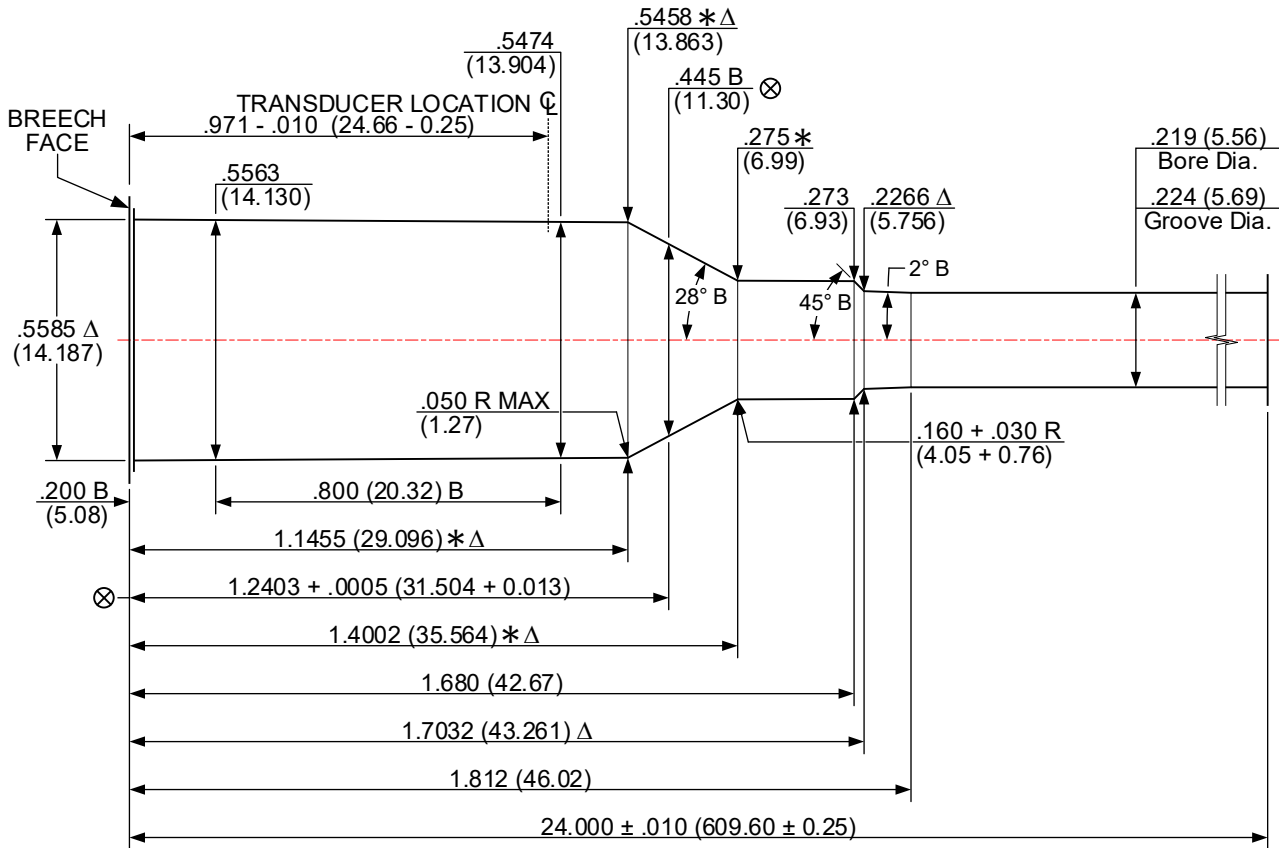

NUMBER OF GROOVES: 6
 WIDTH OF GROOVES: .080 + .002 (2.03 + 0.05)
 TWIST RATE: 10.00 (254.0) R.H.
 DIAMETER OF PISTON HOLE: Crusher pressures not established
 TRANSDUCER DIAMETER: .250 (6.35)

LAND AND GROOVE DIMENSIONS TO BE
 WITHIN TOLERANCES THROUGHOUT
 LENGTH OF BARREL.

UNLESS OTHERWISE NOTED,
 ALL DIAMETERS +.0005 (0.013)
 LENGTH TOLERANCE + .005 (0.13)

DO NOT SCALE FROM DRAWING

NOTES:

B = BASIC

Δ = REFERENCE DIMENSION

\otimes = HEADSPACE DIMENSION

* DIMENSIONS ARE TO INTERSECTIONS OF LINES

(XX.XX) = MILLIMETERS

ALL CALCULATIONS APPLY AT MAXIMUM MATERIAL CONDITION (MMC)

224 VALKYRIE [224 VLK]
 ISSUED: 01/22/2018 V&P TEST BARREL REVISED: 06/28/2023

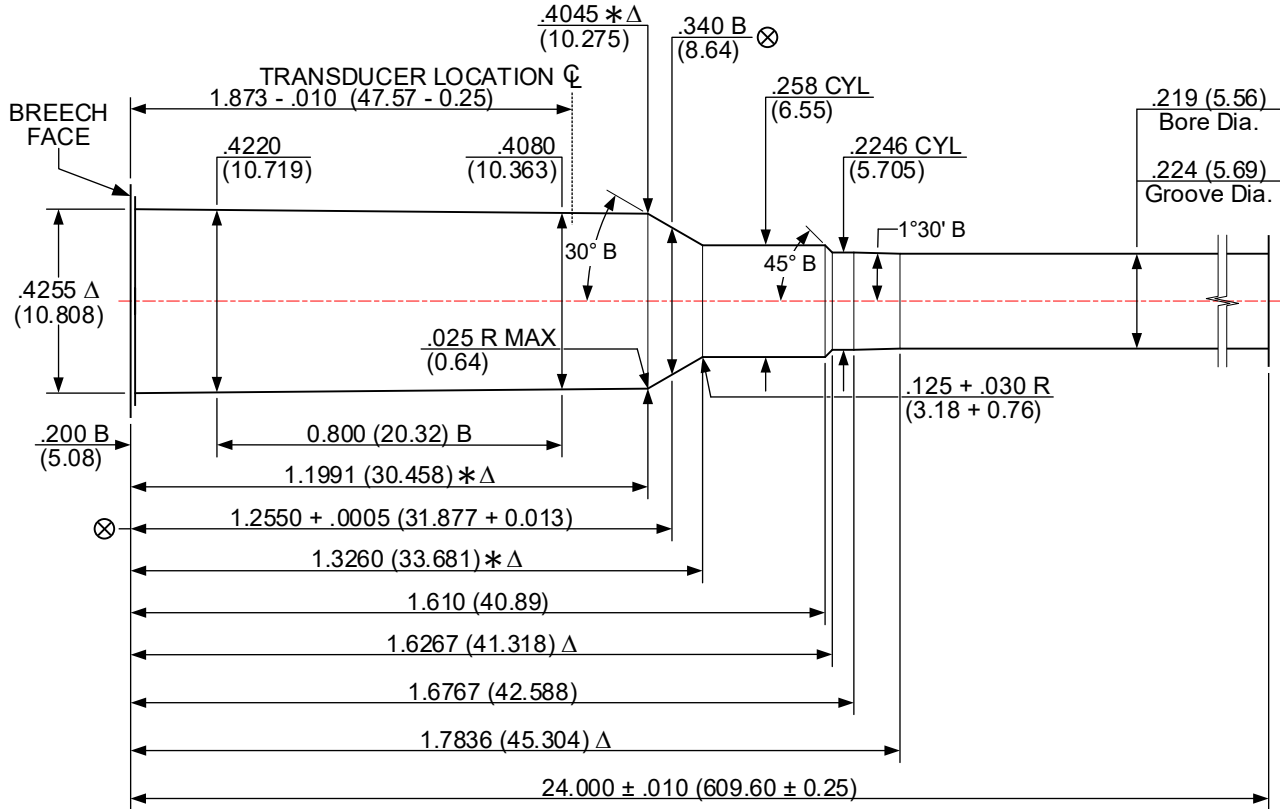

NUMBER OF GROOVES: 6
 WIDTH OF GROOVES: .074 + .002 (1.88 + 0.05)
 TWIST RATE: 7.00 (177.8) R.H.
 DIAMETER OF PISTON HOLE: Crusher pressures not established
 TRANSDUCER DIAMETER: .250 (6.35)

LAND AND GROOVE DIMENSIONS TO BE
 WITHIN TOLERANCES THROUGHOUT
 LENGTH OF BARREL.

UNLESS OTHERWISE NOTED,
 ALL DIAMETERS +.0005 (0.013)
 LENGTH TOLERANCE + .005 (0.13)

DO NOT SCALE FROM DRAWING

NOTES:

B = BASIC

Δ = REFERENCE DIMENSION

⊗ = HEADSPACE DIMENSION

* DIMENSIONS ARE TO INTERSECTIONS OF LINES

(XX.XX) = MILLIMETERS

ALL CALCULATIONS APPLY AT MAXIMUM MATERIAL CONDITION (MMC)

243 WINCHESTER [243 WIN]
 ISSUED: 05/20/1980 V&P TEST BARREL REVISED: 06/26/2023

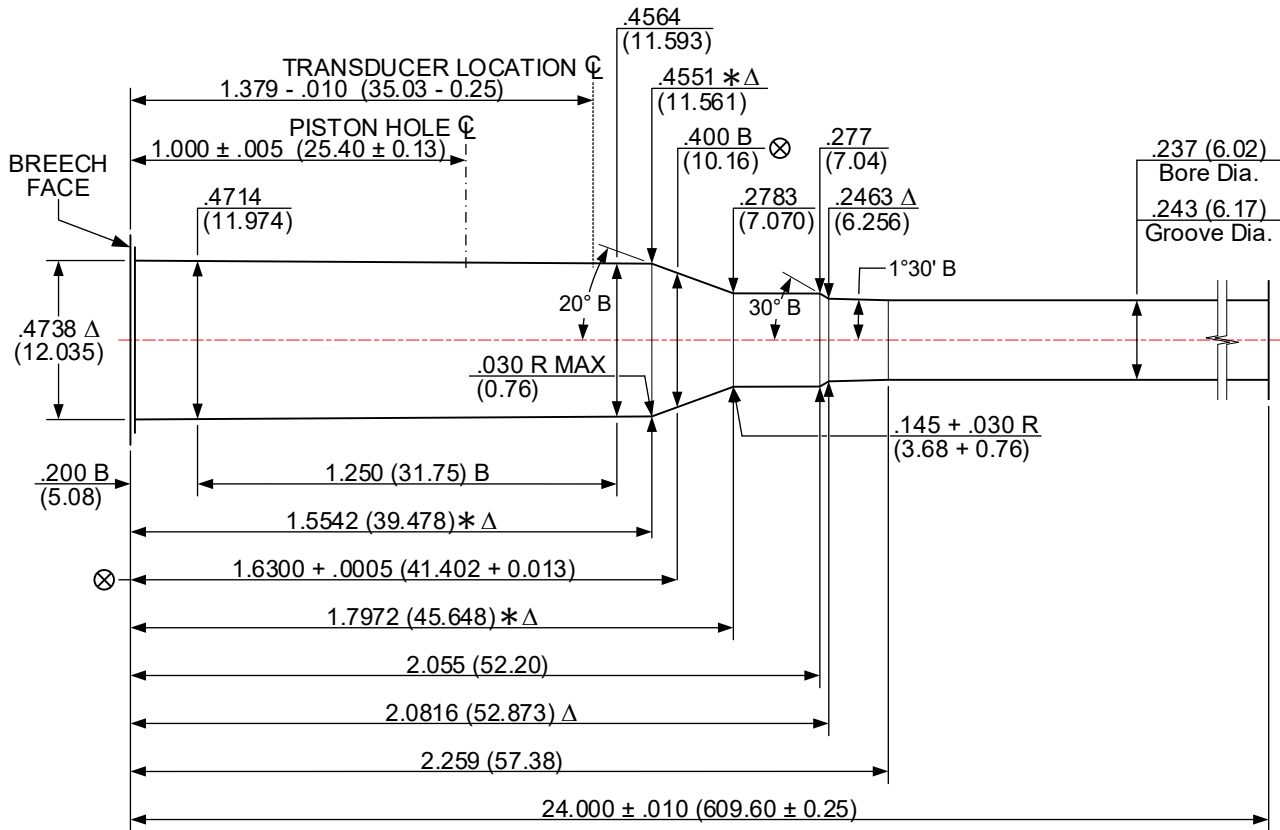

NUMBER OF GROOVES: 6
 WIDTH OF GROOVES: $.068 + .002$ (1.73 + 0.05)
 TWIST RATE: 10.00 (254.0) R.H.
 DIAMETER OF PISTON HOLE: $.206$ (5.23)
 TRANSDUCER DIAMETER: $.250$ (6.35)

LAND AND GROOVE DIMENSIONS TO BE
 WITHIN TOLERANCES THROUGHOUT
 LENGTH OF BARREL.

UNLESS OTHERWISE NOTED,
 ALL DIAMETERS $+ .0005$ (0.013)
 LENGTH TOLERANCE $+ .005$ (0.13)

DO NOT SCALE FROM DRAWING

NOTES:

B = BASIC

Δ = REFERENCE DIMENSION

\otimes = HEADSPACE DIMENSION

* DIMENSIONS ARE TO INTERSECTIONS OF LINES

(XX.XX) = MILLIMETERS

ALL CALCULATIONS APPLY AT MAXIMUM MATERIAL CONDITION (MMC)

243 WINCHESTER SUPER SHORT MAGNUM [243 WSSM]
 ISSUED: 02/11/2004 V&P TEST BARREL REVISED: 06/28/2023

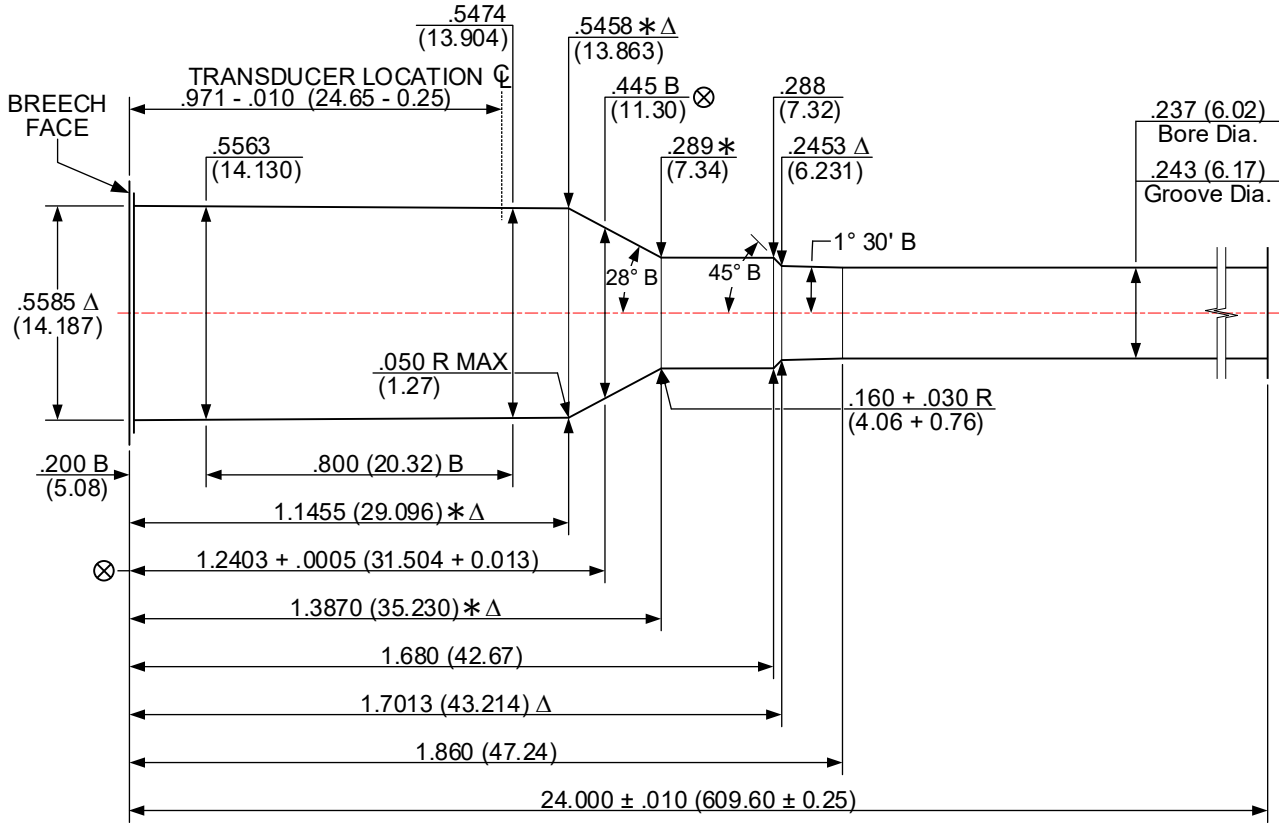

NUMBER OF GROOVES: 4
 WIDTH OF GROOVES: .100 + .002 (2.54 + 0.05)
 TWIST RATE: 10.00 (254.0) R.H.
 DIAMETER OF PISTON HOLE: Crusher pressures not established
 TRANSDUCER DIAMETER: .250 (6.35)

LAND AND GROOVE DIMENSIONS TO BE
 WITHIN TOLERANCES THROUGHOUT
 LENGTH OF BARREL.

UNLESS OTHERWISE NOTED,
 ALL DIAMETERS +.0005 (0.013)
 LENGTH TOLERANCE + .005 (0.13)

DO NOT SCALE FROM DRAWING

NOTES:

B = BASIC

Δ = REFERENCE DIMENSION

⊗ = HEADSPACE DIMENSION

* DIMENSIONS ARE TO INTERSECTIONS OF LINES

(XX.XX) = MILLIMETERS

ALL CALCULATIONS APPLY AT MAXIMUM MATERIAL CONDITION (MMC)

25 WINCHESTER SUPER SHORT MAGNUM [25 WSSM]
 ISSUED: 06/23/2004 V&P TEST BARREL REVISED: 06/23/2023

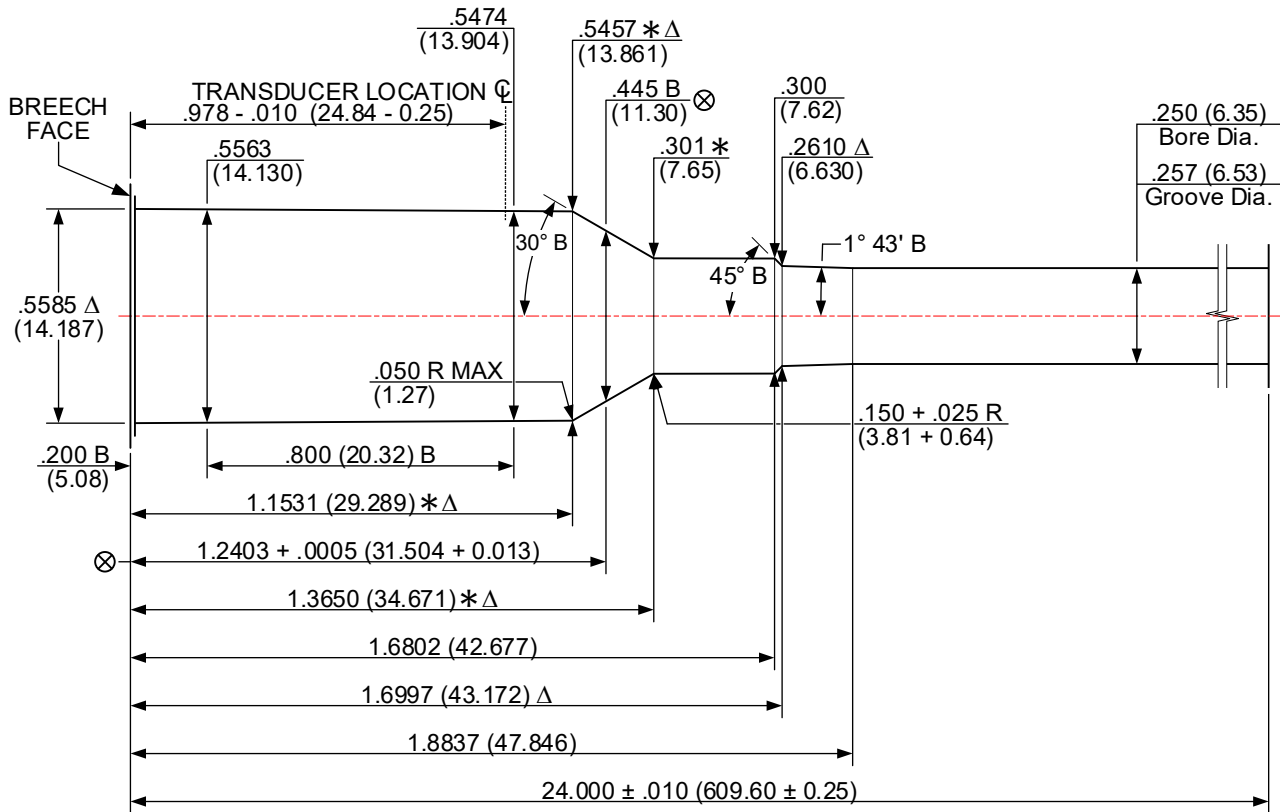

NUMBER OF GROOVES: 6
 WIDTH OF GROOVES: .096 + .002 (2.44 + 0.05)
 TWIST RATE: 10.00 (254.0) R.H.
 DIAMETER OF PISTON HOLE: Crusher pressures not established
 TRANSDUCER DIAMETER: .250 (6.35)

LAND AND GROOVE DIMENSIONS TO BE
 WITHIN TOLERANCES THROUGHOUT
 LENGTH OF BARREL.

UNLESS OTHERWISE NOTED,
 ALL DIAMETERS +.0005 (0.013)
 LENGTH TOLERANCE + .005 (0.13)

DO NOT SCALE FROM DRAWING

NOTES:

B = BASIC

Δ = REFERENCE DIMENSION

⊗ = HEADSPACE DIMENSION

* DIMENSIONS ARE TO INTERSECTIONS OF LINES

(XX.XX) = MILLIMETERS

ALL CALCULATIONS APPLY AT MAXIMUM MATERIAL CONDITION (MMC)

25-06 REMINGTON [25-06 REM]
 ISSUED: 05/20/1980 V&P TEST BARREL REVISED: 03/24/2023

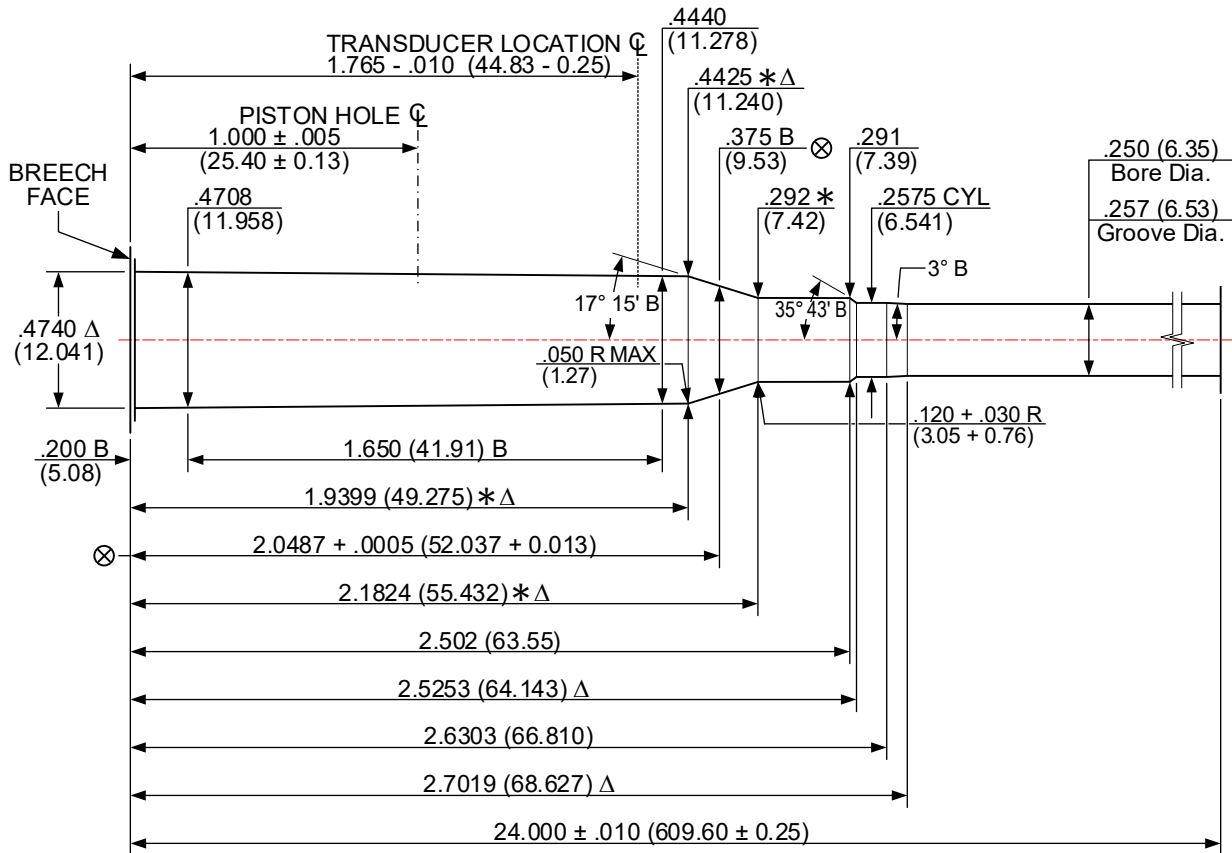

NUMBER OF GROOVES: 6
 WIDTH OF GROOVES: .096 + .002 (2.44 + 0.05)
 TWIST RATE: 10.00 (254.0) R.H.
 DIAMETER OF PISTON HOLE: .206 (5.23)
 TRANSDUCER DIAMETER: .250 (6.35)

LAND AND GROOVE DIMENSIONS TO BE
 WITHIN TOLERANCES THROUGHOUT
 LENGTH OF BARREL.

UNLESS OTHERWISE NOTED,
 ALL DIAMETERS +.0005 (0.013)
 LENGTH TOLERANCE + .005 (0.13)

DO NOT SCALE FROM DRAWING

NOTES:

B = BASIC

Δ = REFERENCE DIMENSION

⊗ = HEADSPACE DIMENSION

* DIMENSIONS ARE TO INTERSECTIONS OF LINES

(XX.XX) = MILLIMETERS

ALL CALCULATIONS APPLY AT MAXIMUM MATERIAL CONDITION (MMC)

25-20 WINCHESTER [25-20 WIN] V&P TEST BARREL
 ISSUED: 05/20/1980 V&P TEST BARREL REVISED: 03/24/2023

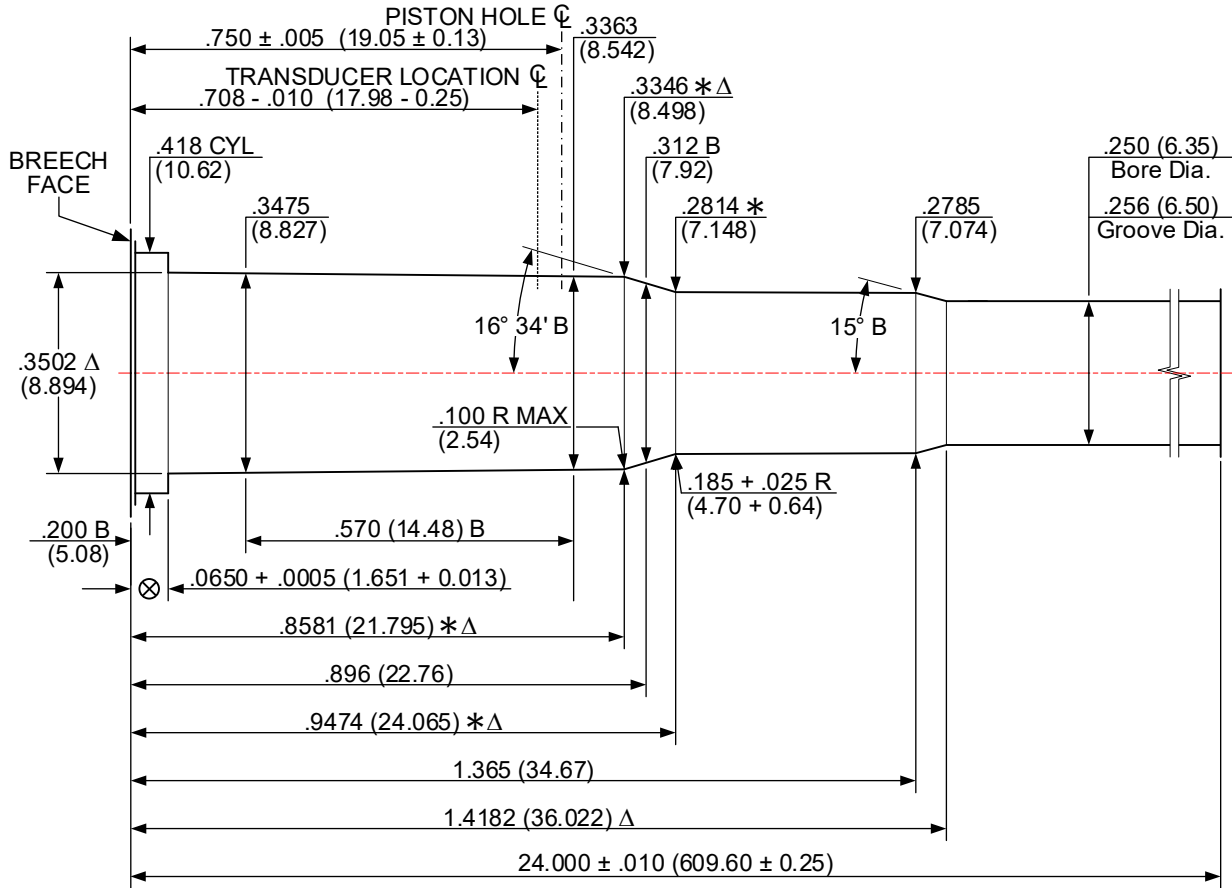

- NUMBER OF GROOVES: 6
- WIDTH OF GROOVES: .078 + .002 (1.98 + 0.05)
- TWIST RATE: 14.00 (355.6) R.H.
- DIAMETER OF PISTON HOLE: .206 (5.23)
- TRANSDUCER DIAMETER: .194 (4.94)**

LAND AND GROOVE DIMENSIONS TO BE WITHIN TOLERANCES THROUGHOUT LENGTH OF BARREL.

UNLESS OTHERWISE NOTED, ALL DIAMETERS +.0005 (0.013) LENGTH TOLERANCE + .005 (0.13)

DO NOT SCALE FROM DRAWING

- NOTES:**
- B = BASIC
 - Δ = REFERENCE DIMENSION
 - ⊗ = HEADSPACE DIMENSION
 - * DIMENSIONS ARE TO INTERSECTIONS OF LINES
 - (XX.XX) = MILLIMETERS
 - ALL CALCULATIONS APPLY AT MAXIMUM MATERIAL CONDITION (MMC)

25-35 WINCHESTER [25-35 WIN]

ISSUED: 01/25/2005 V&P TEST BARREL REVISED: 06/23/2023

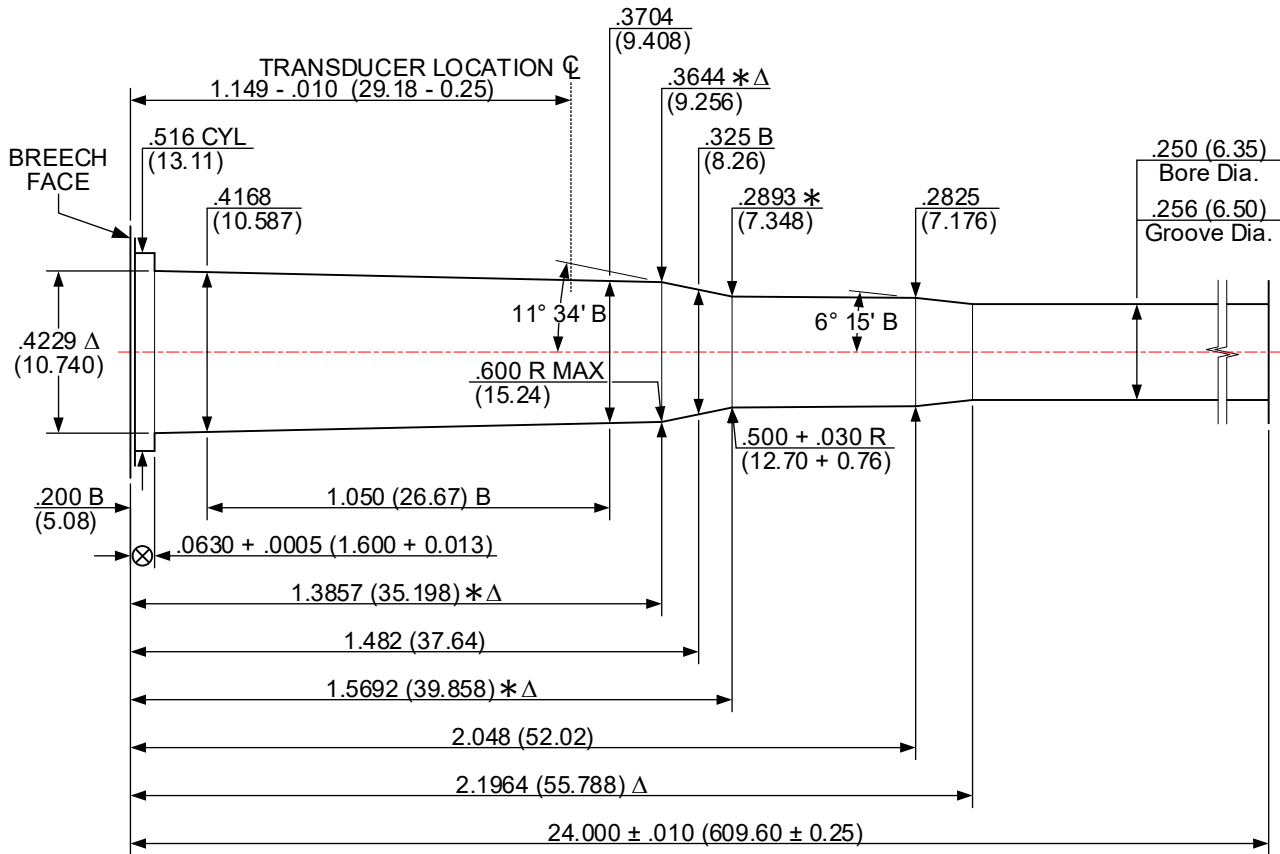

NUMBER OF GROOVES: 6
 WIDTH OF GROOVES: .0786 + .0020 (1.996 + 0.051)
 TWIST RATE: 8.00 (203.2) R.H.
 DIAMETER OF PISTON HOLE: .206 (5.23)
 TRANSDUCER DIAMETER: .250 (6.35)

LAND AND GROOVE DIMENSIONS TO BE
 WITHIN TOLERANCES THROUGHOUT
 LENGTH OF BARREL.

UNLESS OTHERWISE NOTED,
 ALL DIAMETERS +.0005 (0.013)
 LENGTH TOLERANCE + .005 (0.13)

DO NOT SCALE FROM DRAWING

NOTES:

B = BASIC

Δ = REFERENCE DIMENSION

⊗ = HEADSPACE DIMENSION

* DIMENSIONS ARE TO INTERSECTIONS OF LINES

(XX.XX) = MILLIMETERS

ALL CALCULATIONS APPLY AT MAXIMUM MATERIAL CONDITION (MMC)

250 SAVAGE [250 SAV]
V&P TEST BARREL

ISSUED: 05/20/1980

REVISED: 06/23/2023

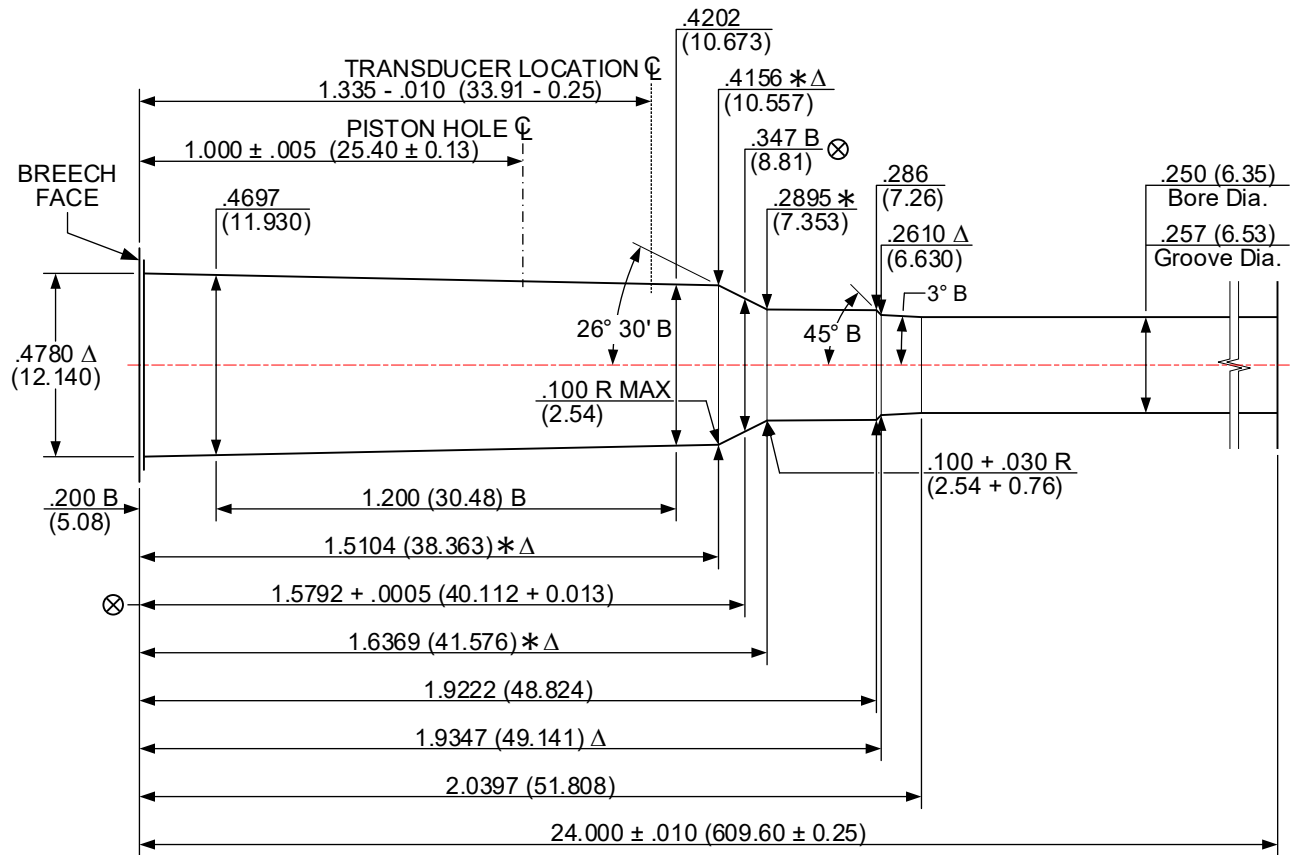

NUMBER OF GROOVES: 6
 WIDTH OF GROOVES: .088 + .002 (2.24 + 0.05)
 TWIST RATE: 14.00 (355.6) R.H.
 DIAMETER OF PISTON HOLE: .206 (5.23)
 TRANSDUCER DIAMETER: .250 (6.35)

LAND AND GROOVE DIMENSIONS TO BE
 WITHIN TOLERANCES THROUGHOUT
 LENGTH OF BARREL.

UNLESS OTHERWISE NOTED,
 ALL DIAMETERS +.0005 (0.013)
 LENGTH TOLERANCE + .005 (0.13)

DO NOT SCALE FROM DRAWING

NOTES:

B = BASIC

Δ = REFERENCE DIMENSION

\otimes = HEADSPACE DIMENSION

* DIMENSIONS ARE TO INTERSECTIONS OF LINES

(XX.XX) = MILLIMETERS

ALL CALCULATIONS APPLY AT MAXIMUM MATERIAL CONDITION (MMC)

257 ROBERTS [257 ROB] / 257 ROBERTS +P [257 ROB +P]
 ISSUED: 05/20/1980 V&P TEST BARREL REVISED: 07/07/2023

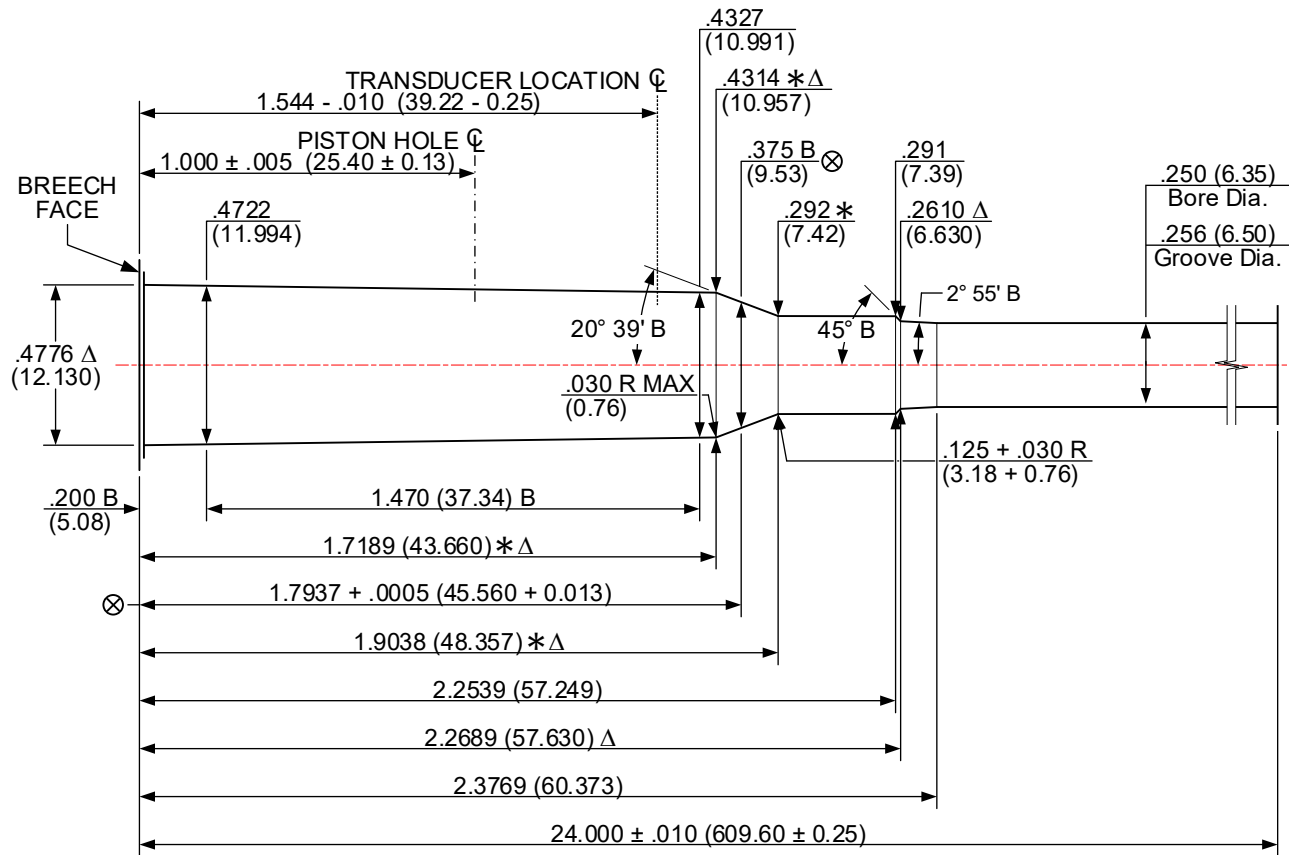

NUMBER OF GROOVES: 6
 WIDTH OF GROOVES: .095 + .002 (2.41 + 0.05)
 TWIST RATE: 10.00 (254.0) R.H.
 DIAMETER OF PISTON HOLE: .206 (5.23)
 TRANSDUCER DIAMETER: .250 (6.35)

LAND AND GROOVE DIMENSIONS TO BE
 WITHIN TOLERANCES THROUGHOUT
 LENGTH OF BARREL.

UNLESS OTHERWISE NOTED,
 ALL DIAMETERS +.0005 (0.013)
 LENGTH TOLERANCE + .005 (0.13)

DO NOT SCALE FROM DRAWING

NOTE:

B = BASIC

Δ = REFERENCE DIMENSION

⊗ = HEADSPACE DIMENSION

* DIMENSIONS ARE TO INTERSECTIONS OF LINES

(XX.XX) = MILLIMETERS

ALL CALCULATIONS APPLY AT MAXIMUM MATERIAL CONDITION (MMC)

257 WEATHERBY MAGNUM [257 WBY MAG]
 ISSUED: 01/12/1984 V&P TEST BARREL REVISED: 01/21/2024

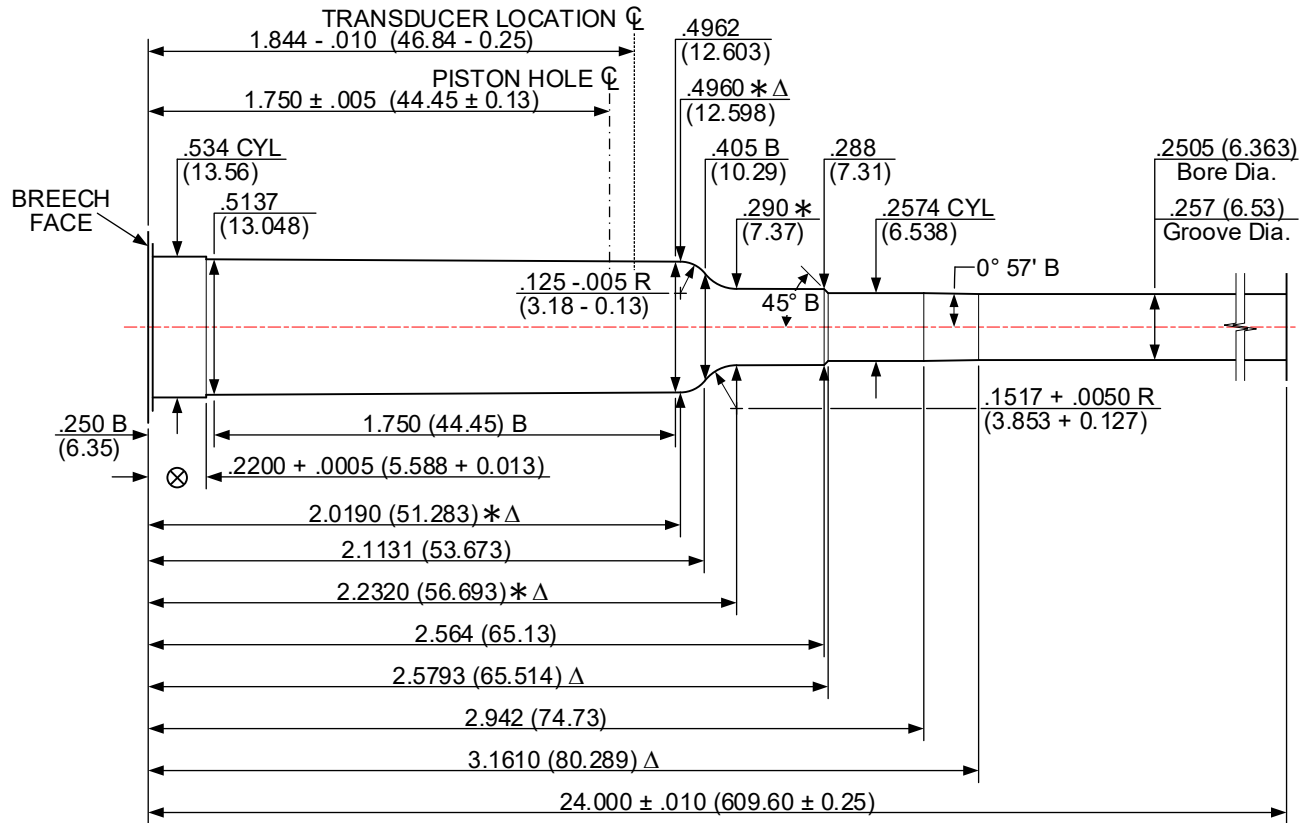

NUMBER OF GROOVES: 6
 WIDTH OF GROOVES: .098 + .002 (2.49 + 0.05)
 TWIST RATE: 10.00 (254.0) R.H.
 DIAMETER OF PISTON HOLE: .206 (5.23)
 TRANSDUCER DIAMETER: .250 (6.35)

LAND AND GROOVE DIMENSIONS TO BE
 WITHIN TOLERANCES THROUGHOUT
 LENGTH OF BARREL.

UNLESS OTHERWISE NOTED,
 ALL DIAMETERS +.0005 (0.013)
 LENGTH TOLERANCE + .005 (0.13)

DO NOT SCALE FROM DRAWING

NOTE:

B = BASIC

Δ = REFERENCE DIMENSION

⊗ = HEADSPACE DIMENSION

* DIMENSIONS ARE TO INTERSECTIONS OF LINES

(XX.XX) = MILLIMETERS

ALL CALCULATIONS APPLY AT MAXIMUM MATERIAL CONDITION (MMC)

26 Nosler (26 NOSLER)
 ISSUED: 01/01/2014 V&P TEST BARREL REVISED: 10/12/2021

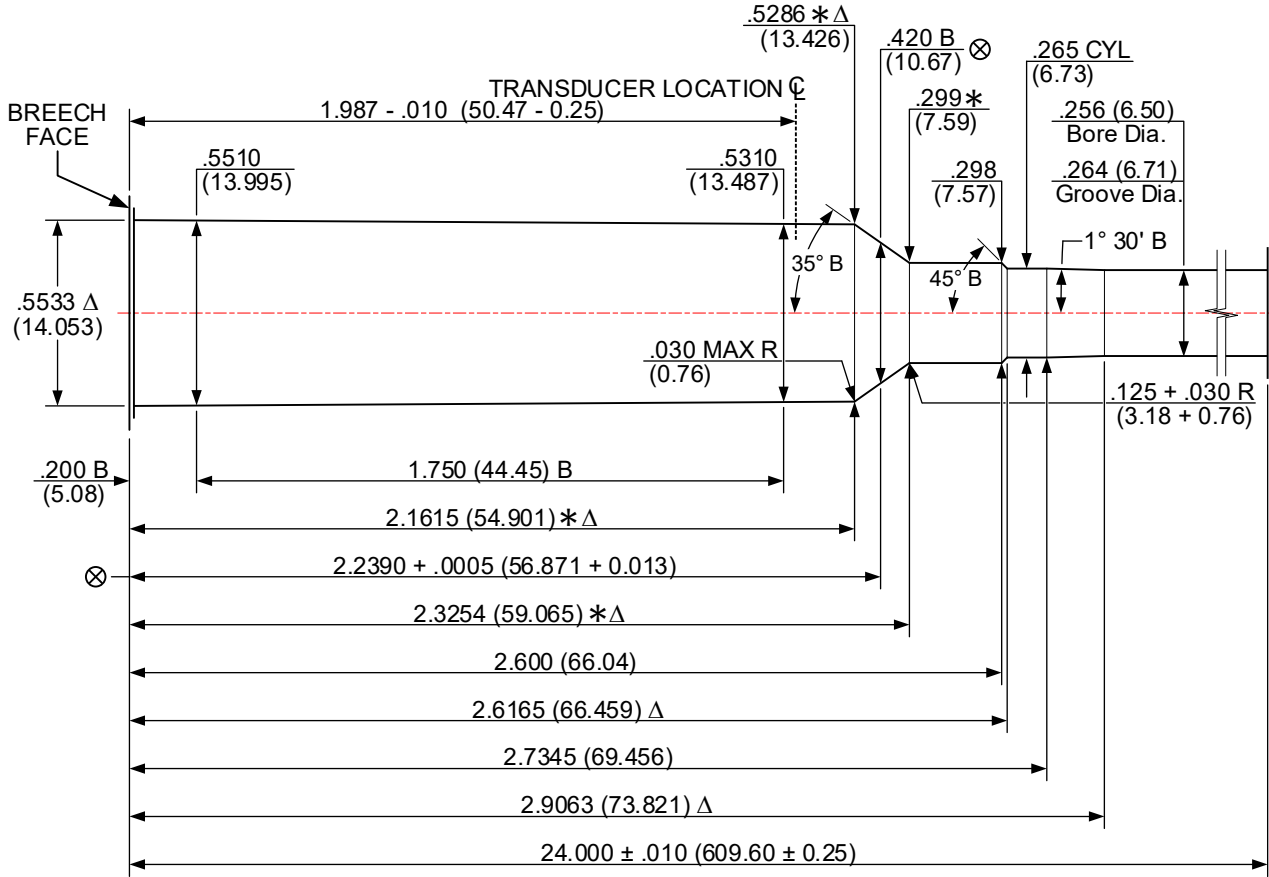

NUMBER OF GROOVES: 4
 WIDTH OF GROOVES: $.095 + .002$ (2.41 + 0.05)
 TWIST RATE: 8.00 (203.2) R.H.
 DIAMETER OF PISTON HOLE: Crusher pressures not established
 TRANSDUCER DIAMETER: $.250$ (6.35)

LAND AND GROOVE DIMENSIONS TO BE WITHIN TOLERANCES THROUGHOUT LENGTH OF BARREL.

UNLESS OTHERWISE NOTED, ALL DIAMETERS $+0.0005$ (0.013) LENGTH TOLERANCE $+ .005$ (0.13)

DO NOT SCALE FROM DRAWING

NOTES:

- B = BASIC Δ = REFERENCE DIMENSION \otimes = HEADSPACE DIMENSION
- * DIMENSIONS ARE TO INTERSECTIONS OF LINES (XX.XX) = MILLIMETERS
- ALL CALCULATIONS APPLY AT MAXIMUM MATERIAL CONDITION (MMC)

260 REMINGTON [260 REM]
 ISSUED: 01/29/1997 V&P TEST BARREL REVISED: 06/26/2023

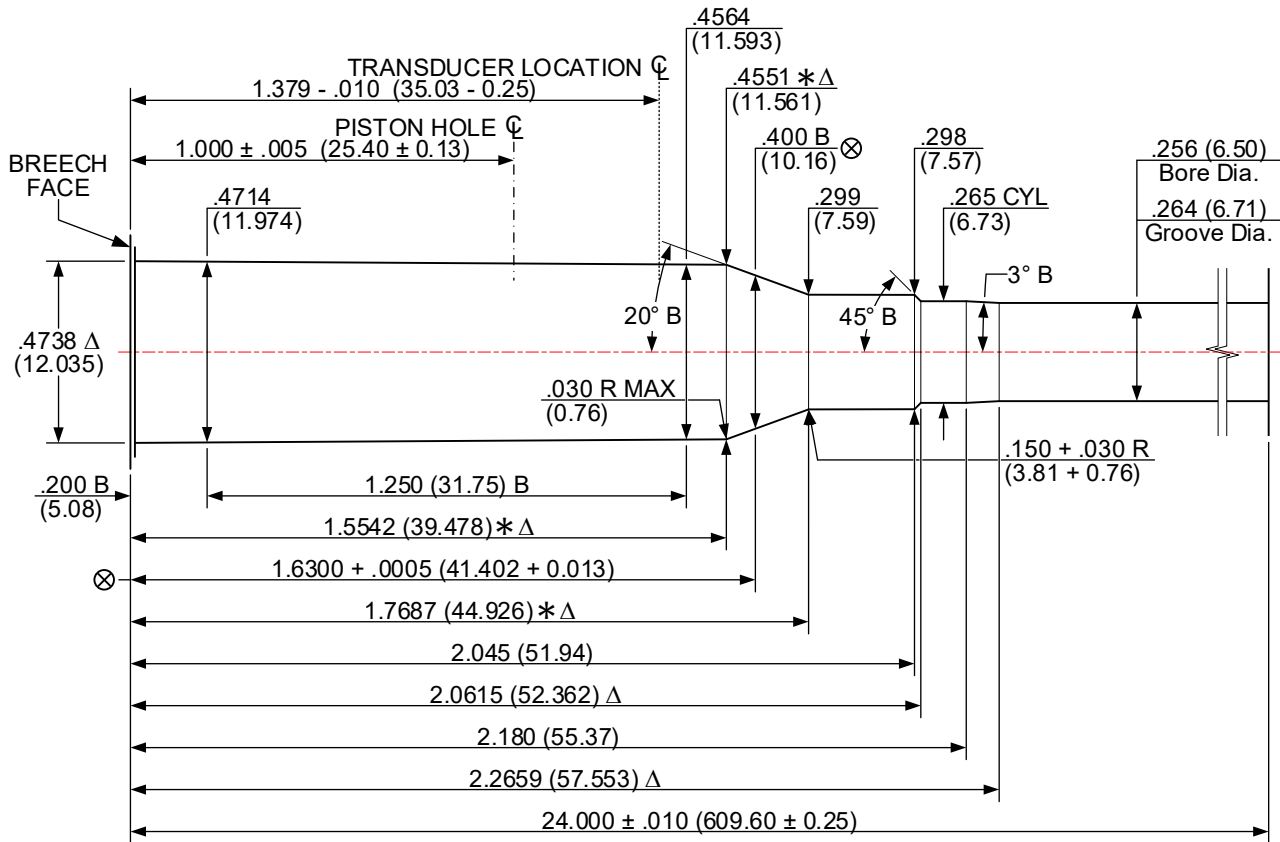

NUMBER OF GROOVES: 6
 WIDTH OF GROOVES: .095 + .002 (2.41 + 0.05)
 TWIST RATE: 9.00 (228.6) R.H.
 DIAMETER OF PISTON HOLE: .206 (5.23)
 TRANSDUCER DIAMETER: .250 (6.35)

LAND AND GROOVE DIMENSIONS TO BE
 WITHIN TOLERANCES THROUGHOUT
 LENGTH OF BARREL.

UNLESS OTHERWISE NOTED,
 ALL DIAMETERS +.0005 (0.013)
 LENGTH TOLERANCE + .005 (0.13)

DO NOT SCALE FROM DRAWING

NOTES:

B = BASIC

Δ = REFERENCE DIMENSION

\otimes = HEADSPACE DIMENSION

* DIMENSIONS ARE TO INTERSECTIONS OF LINES

(XX.XX) = MILLIMETERS

ALL CALCULATIONS APPLY AT MAXIMUM MATERIAL CONDITION (MMC)

264 WINCHESTER MAGNUM [264 WIN MAG]
 ISSUED: 05/20/1980 V&P TEST BARREL REVISED: 06/26/2023

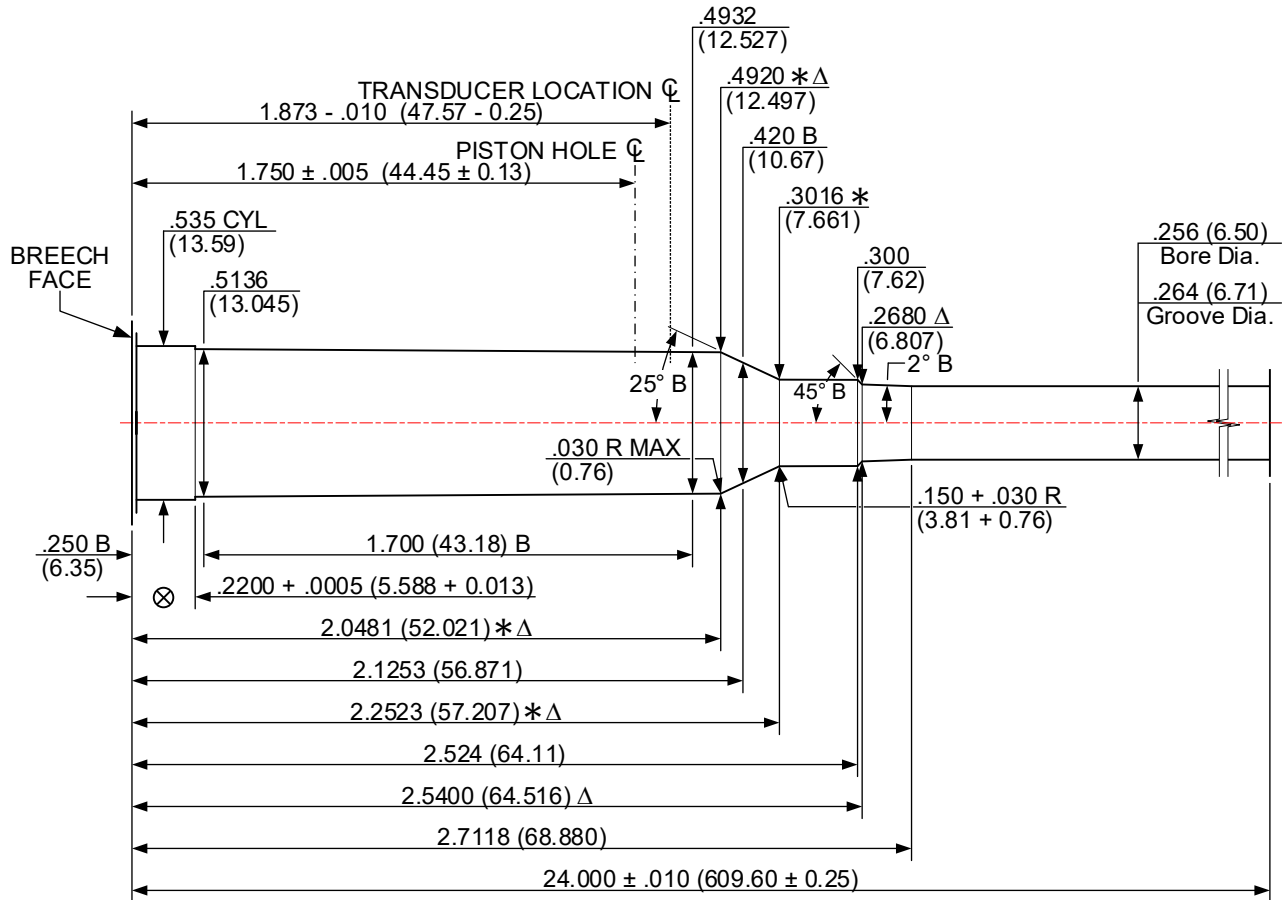

NUMBER OF GROOVES: 6
 WIDTH OF GROOVES: .090 + .002 (2.29 + 0.05)
 TWIST RATE: 9.00 (228.6) R.H.
 DIAMETER OF PISTON HOLE: .206 (5.23)
 TRANSDUCER DIAMETER: .250 (6.35)

LAND AND GROOVE DIMENSIONS TO BE
 WITHIN TOLERANCES THROUGHOUT
 LENGTH OF BARREL.

UNLESS OTHERWISE NOTED,
 ALL DIAMETERS +.0005 (0.013)
 LENGTH TOLERANCE + .005 (0.13)

DO NOT SCALE FROM DRAWING

NOTES:

- B = BASIC
- Δ = REFERENCE DIMENSION
- * DIMENSIONS ARE TO INTERSECTIONS OF LINES
- ⊗ = HEADSPACE DIMENSION
- (XX.XX) = MILLIMETERS
- ALL CALCULATIONS APPLY AT MAXIMUM MATERIAL CONDITION (MMC)

27 Nosler [27 NOSLER]
 ISSUED: 01/19/2015 V&P TEST BARREL REVISED: 06/26/2023

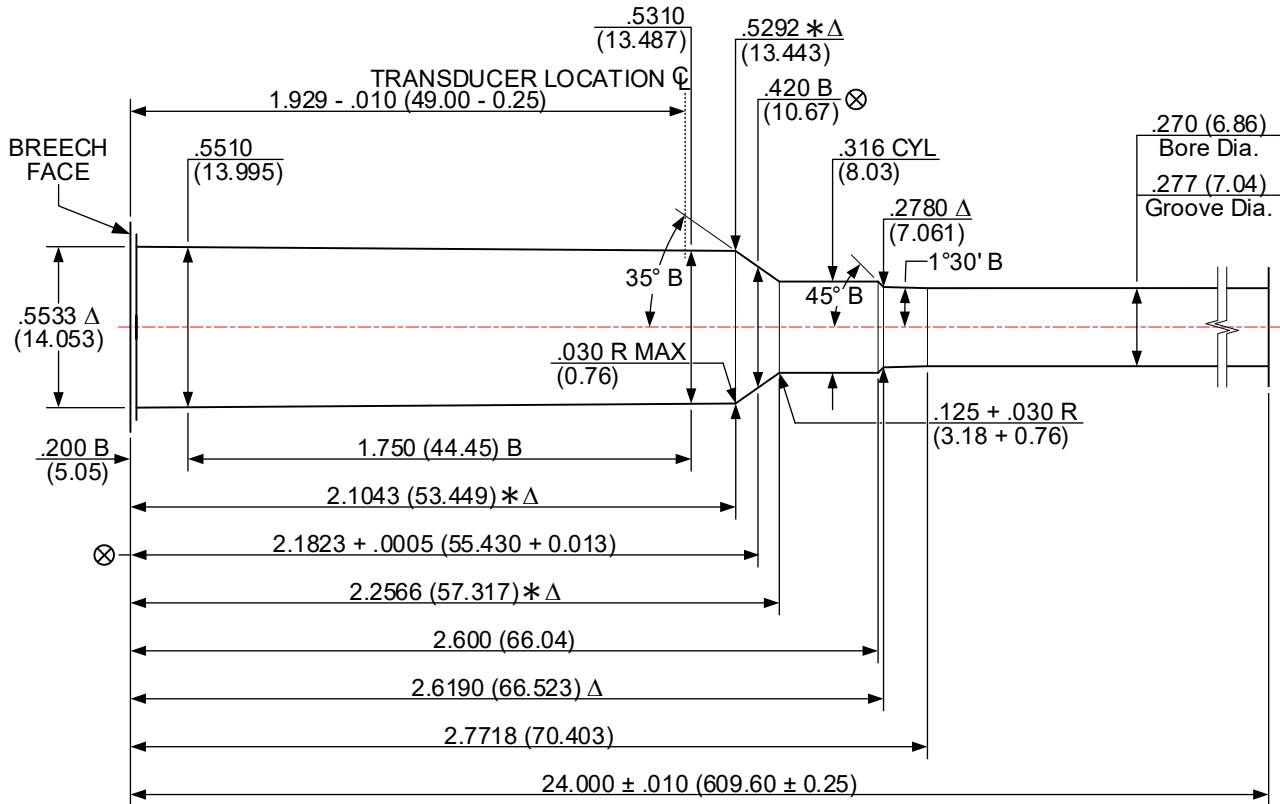

NUMBER OF GROOVES: 4
 WIDTH OF GROOVES: .160 + .002 (4.06 + 0.05)
 TWIST RATE: 8.50 (215.9) R.H.
 DIAMETER OF PISTON HOLE: Crusher pressures not established.
 TRANSDUCER DIAMETER: .250 (6.35)

LAND AND GROOVE DIMENSIONS TO BE
 WITHIN TOLERANCES THROUGHOUT
 LENGTH OF BARREL.

UNLESS OTHERWISE NOTED,
 ALL DIAMETERS +.0005 (0.013)
 LENGTH TOLERANCE + .005 (0.13)

DO NOT SCALE FROM DRAWING

NOTES:

B = BASIC

Δ = REFERENCE DIMENSION

⊗ = HEADSPACE DIMENSION

* DIMENSIONS ARE TO INTERSECTIONS OF LINES

(XX.XX) = MILLIMETERS

ALL CALCULATIONS APPLY AT MAXIMUM MATERIAL CONDITION (MMC)

270 WEATHERBY MAGNUM [270 WBY MAG]
 ISSUED: 09/16/1996 V&P TEST BARREL REVISED: 01/21/2024

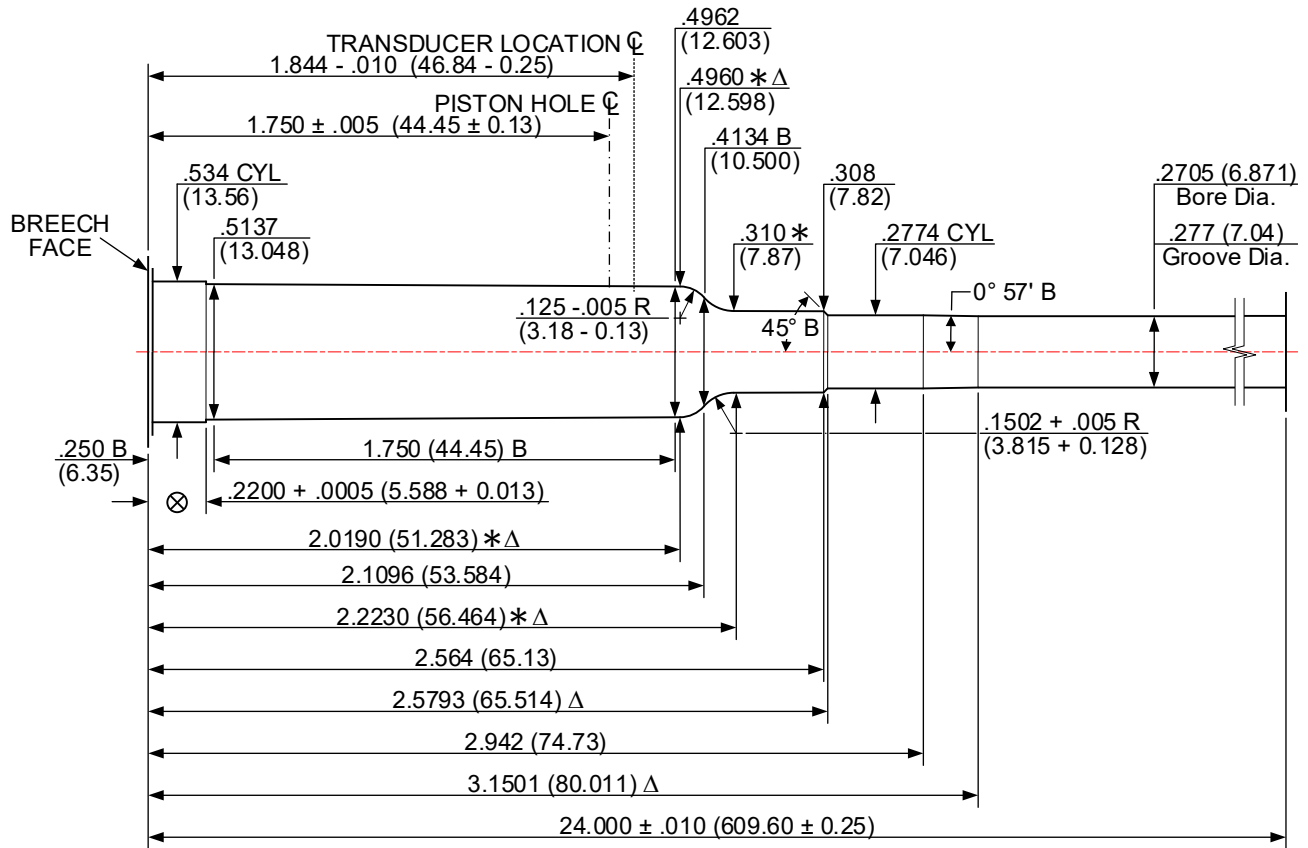

NUMBER OF GROOVES: 6
 WIDTH OF GROOVES: .108 + .002 (2.74 + 0.05)
 TWIST RATE: 10.00 (254.0) R.H.
 DIAMETER OF PISTON HOLE: .206 (5.23)
 TRANSDUCER DIAMETER: .250 (6.35)

LAND AND GROOVE DIMENSIONS TO BE
 WITHIN TOLERANCES THROUGHOUT
 LENGTH OF BARREL.

UNLESS OTHERWISE NOTED,
 ALL DIAMETERS +.0005 (0.013)
 LENGTH TOLERANCE + .005 (0.13)

DO NOT SCALE FROM DRAWING

NOTES:

B = BASIC

Δ = REFERENCE DIMENSION

⊗ = HEADSPACE DIMENSION

* DIMENSIONS ARE TO INTERSECTIONS OF LINES

(XX.XX) = MILLIMETERS

ALL CALCULATIONS APPLY AT MAXIMUM MATERIAL CONDITION (MMC)

270 WINCHESTER [270 WIN]
 ISSUED: 05/20/1980 V&P TEST BARREL REVISED: 06/26/2023

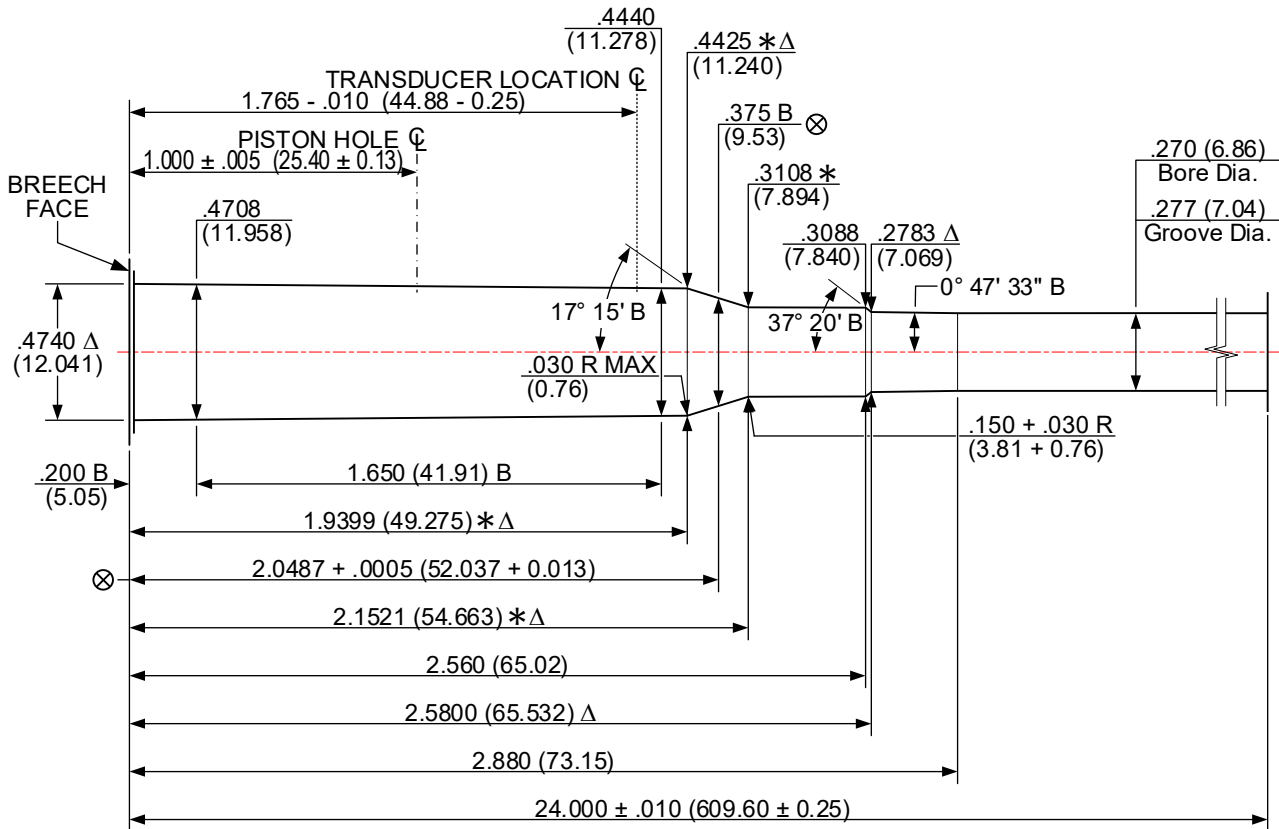

NUMBER OF GROOVES: 4
 WIDTH OF GROOVES: .160 + .002 (4.06 + 0.05)
 TWIST RATE: 10.00 (254.0) R.H.
 DIAMETER OF PISTON HOLE: .206 (5.23)
 TRANSDUCER DIAMETER: .250 (6.35)

LAND AND GROOVE DIMENSIONS TO BE
 WITHIN TOLERANCES THROUGHOUT
 LENGTH OF BARREL.

UNLESS OTHERWISE NOTED,
 ALL DIAMETERS +.0005 (0.013)
 LENGTH TOLERANCE + .005 (0.13)

DO NOT SCALE FROM DRAWING

NOTES:

B = BASIC

Δ = REFERENCE DIMENSION

⊗ = HEADSPACE DIMENSION

* DIMENSIONS ARE TO INTERSECTIONS OF LINES

(XX.XX) = MILLIMETERS

ALL CALCULATIONS APPLY AT MAXIMUM MATERIAL CONDITION (MMC)

270 WINCHESTER SHORT MAGNUM [270 WSM]
 ISSUED: 02/01/2002 V&P TEST BARREL REVISED: 06/27/2023

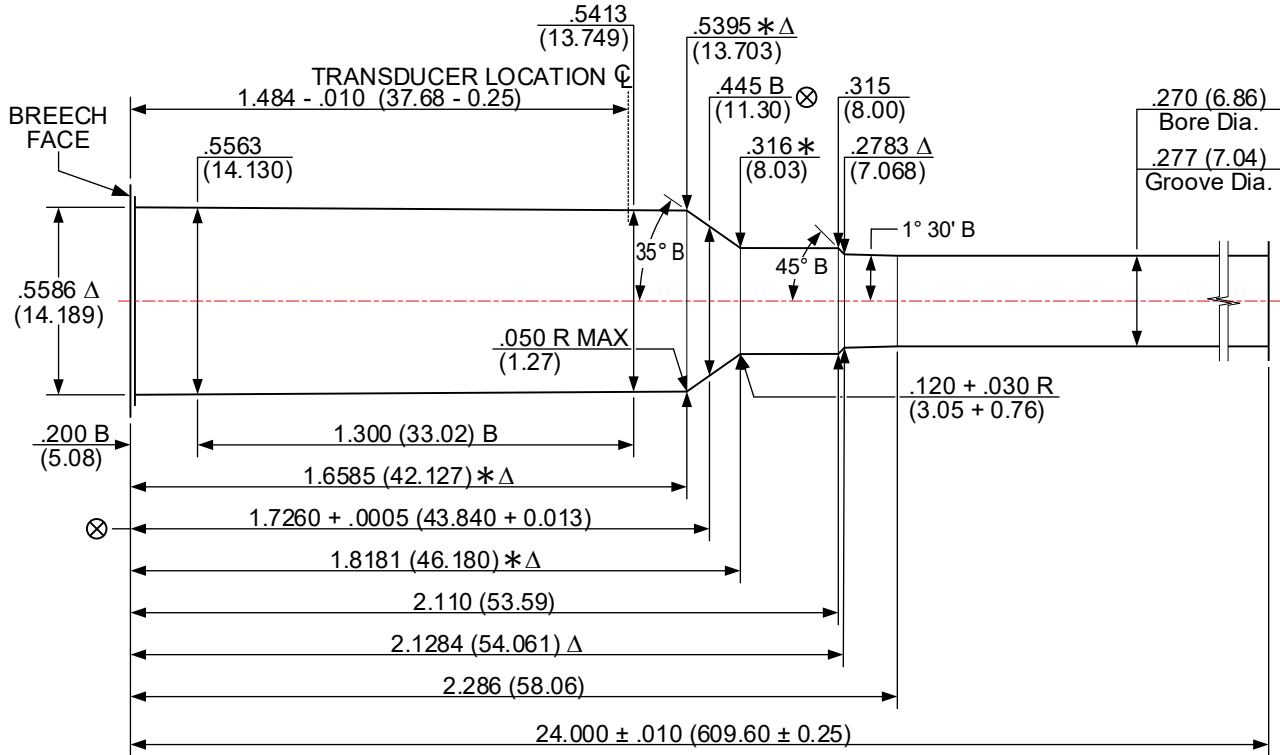

NUMBER OF GROOVES: 4
 WIDTH OF GROOVES: $.160 + .002$ (4.06 + 0.05)
 TWIST RATE: 10.00 (254.0) R.H.
 DIAMETER OF PISTON HOLE: Crusher pressures not established
 TRANSUDUCER DIAMETER: $.250$ (6.35)

LAND AND GROOVE DIMENSIONS TO BE
 WITHIN TOLERANCES THROUGHOUT
 LENGTH OF BARREL.

UNLESS OTHERWISE NOTED,
 ALL DIAMETERS $+ .0005$ (0.013)
 LENGTH TOLERANCE $+ .005$ (0.13)

DO NOT SCALE FROM DRAWING

NOTES:

B = BASIC

Δ = REFERENCE DIMENSION

\otimes = HEADSPACE DIMENSION

* DIMENSIONS ARE TO INTERSECTIONS OF LINES

(XX.XX) = MILLIMETERS

ALL CALCULATIONS APPLY AT MAXIMUM MATERIAL CONDITION (MMC)

277 SIG FURY [277 SIG FURY]

ISSUED: 09/23/2020

V&P TEST BARREL

REVISED: 07/07/2023

WARNING:

Maximum Average Pressure levels greater than 65,000 psi may present increased risk of unsafe cartridge case or firearm rupture and thus require cartridge case and/or firearm designs that depart from traditional practices (materials, construction, and other design criteria).

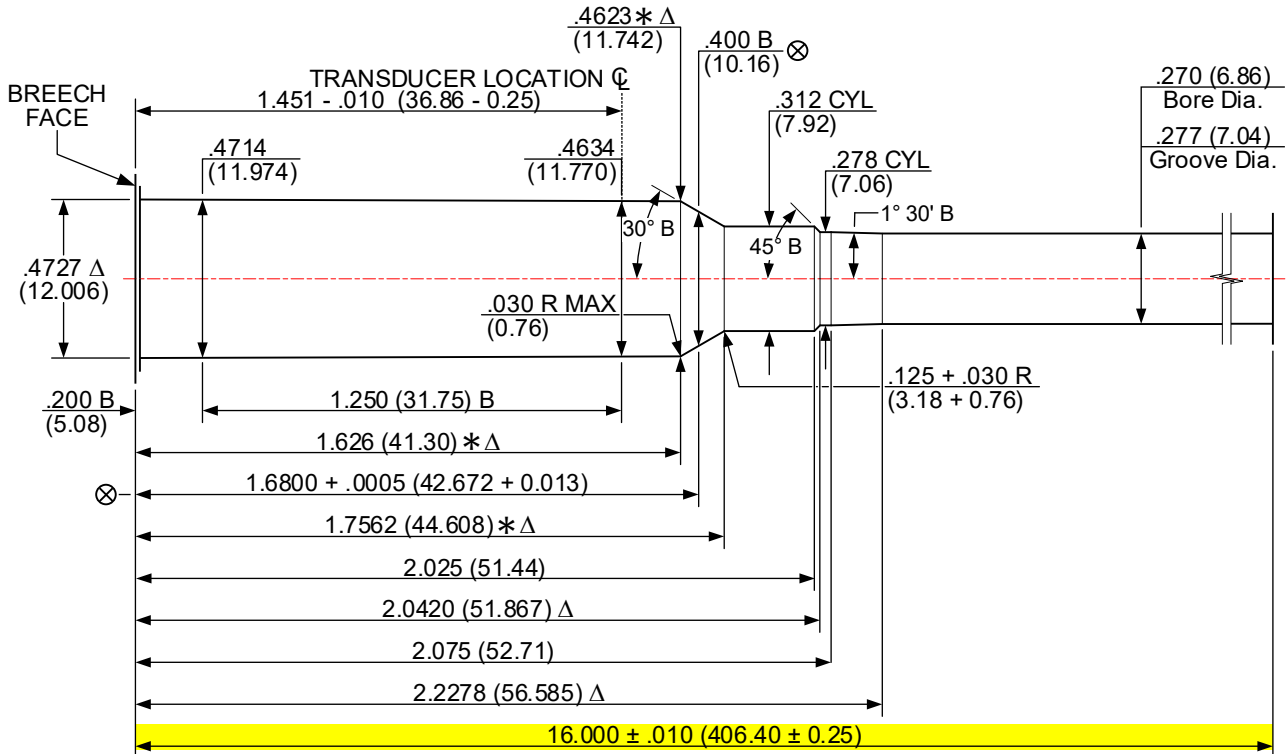

NUMBER OF GROOVES: 6
 WIDTH OF GROOVES: .108 + .002 (4.06 + 0.05)
 TWIST RATE: 7.00 (177.8) RH
 DIAMETER OF PISTON HOLE: Crusher pressures not established

TRANSUCER: .250 (6.35) DIAMETER / .50 (12.7) THREAD

LAND AND GROOVE DIMENSIONS TO BE
 WITHIN TOLERANCES THROUGHOUT
 LENGTH OF BARREL.

UNLESS OTHERWISE NOTED,
 ALL DIAMETERS +.0005 (0.013)
 LENGTH TOLERANCE + .005 (0.13)

DO NOT SCALE FROM DRAWING

NOTES:

B = BASIC

Δ = REFERENCE DIMENSION

⊗ = HEADSPACE DIMENSION

* DIMENSIONS ARE TO INTERSECTIONS OF LINES

(XX.XX) = MILLIMETERS

ALL CALCULATIONS APPLY AT MAXIMUM MATERIAL CONDITION (MMC)

28 Nosler [28 NOSLER]
ISSUED: 01/19/2015 **V&P TEST BARREL** **REVISED: 06/29/2023**

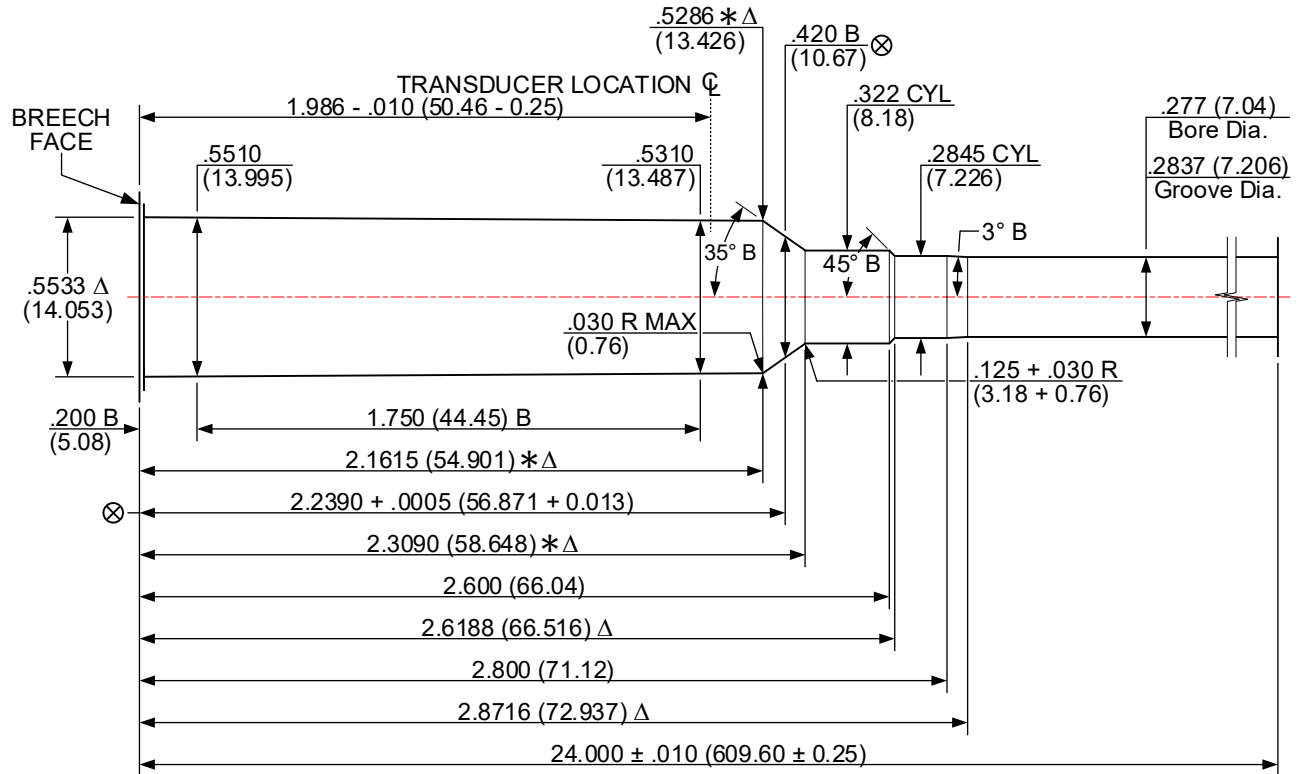

NUMBER OF GROOVES: 6
 WIDTH OF GROOVES: .110 + .002 (2.79 + 0.05)
 TWIST RATE: 9.00 (228.6) R.H.
 DIAMETER OF PISTON HOLE: Crusher pressures not established.
 TRANSDUCER DIAMETER: .250 (6.35)

LAND AND GROOVE DIMENSIONS TO BE
 WITHIN TOLERANCES THROUGHOUT
 LENGTH OF BARREL.

UNLESS OTHERWISE NOTED,
 ALL DIAMETERS +.0005 (0.013)
 LENGTH TOLERANCE + .005 (0.13)

DO NOT SCALE FROM DRAWING

NOTES:

B = BASIC

Δ = REFERENCE DIMENSION

⊗ = HEADSPACE DIMENSION

* DIMENSIONS ARE TO INTERSECTIONS OF LINES

(XX.XX) = MILLIMETERS

ALL CALCULATIONS APPLY AT MAXIMUM MATERIAL CONDITION (MMC)

280 ACKLEY IMPROVED [280 ACK IMP]
 ISSUED: 09/09/2007 V&P TEST BARREL REVISED: 06/29/2023

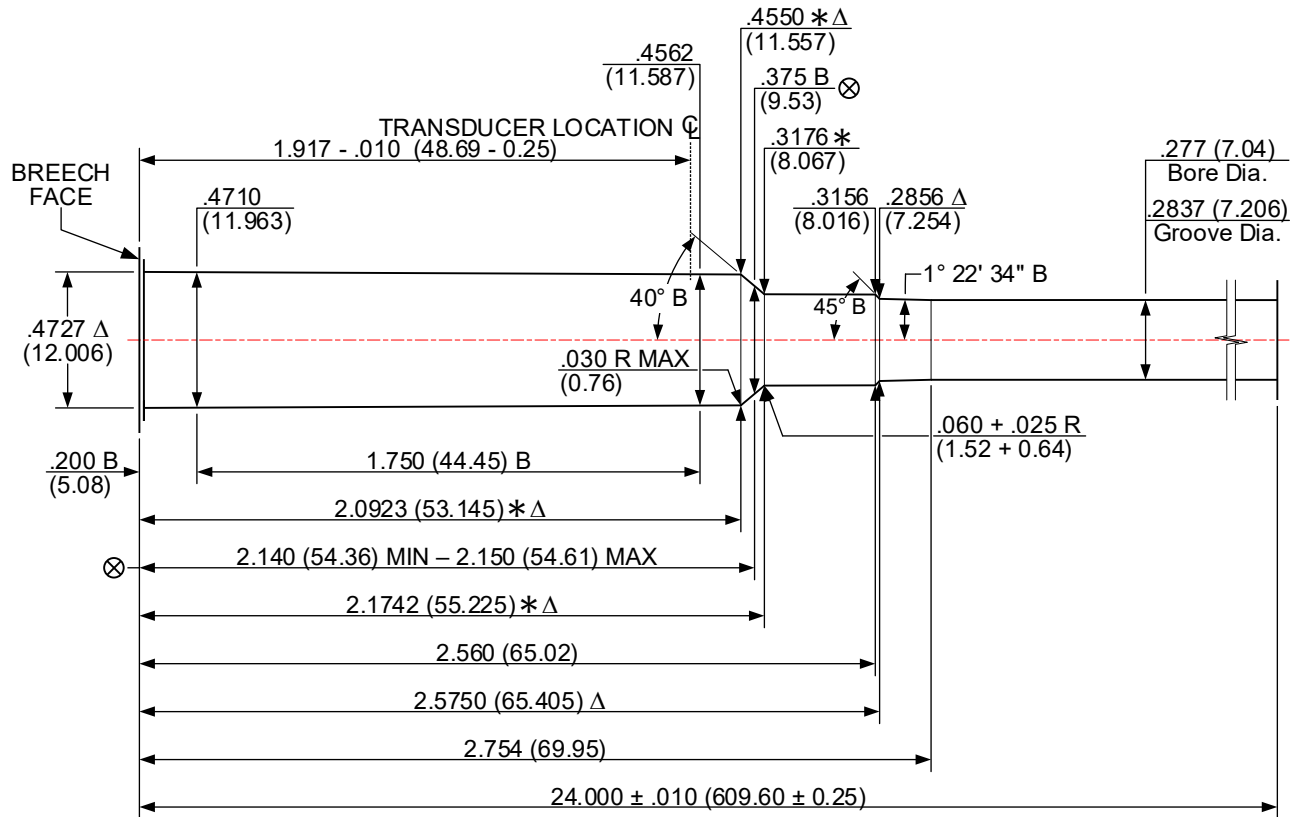

NUMBER OF GROOVES: 4
 WIDTH OF GROOVES: .160 + .002 (4.06 + 0.05)
 TWIST RATE: 9.00 (228.6) R.H.
 DIAMETER OF PISTON HOLE: Crusher pressures not established
 TRANSDUCER DIAMETER: .250 (6.35)

LAND AND GROOVE DIMENSIONS TO BE
 WITHIN TOLERANCES THROUGHOUT
 LENGTH OF BARREL.

UNLESS OTHERWISE NOTED,
 ALL DIAMETERS +.0005 (0.013)
 LENGTH TOLERANCE + .005 (0.13)

DO NOT SCALE FROM DRAWING

NOTES:

B = BASIC

Δ = REFERENCE DIMENSION

⊗ = HEADSPACE DIMENSION

* DIMENSIONS ARE TO INTERSECTIONS OF LINES

(XX.XX) = MILLIMETERS

ALL CALCULATIONS APPLY AT MAXIMUM MATERIAL CONDITION (MMC)

284 WINCHESTER [284 WIN]
 ISSUED: 05/20/1980 V&P TEST BARREL REVISED: 06/30/2023

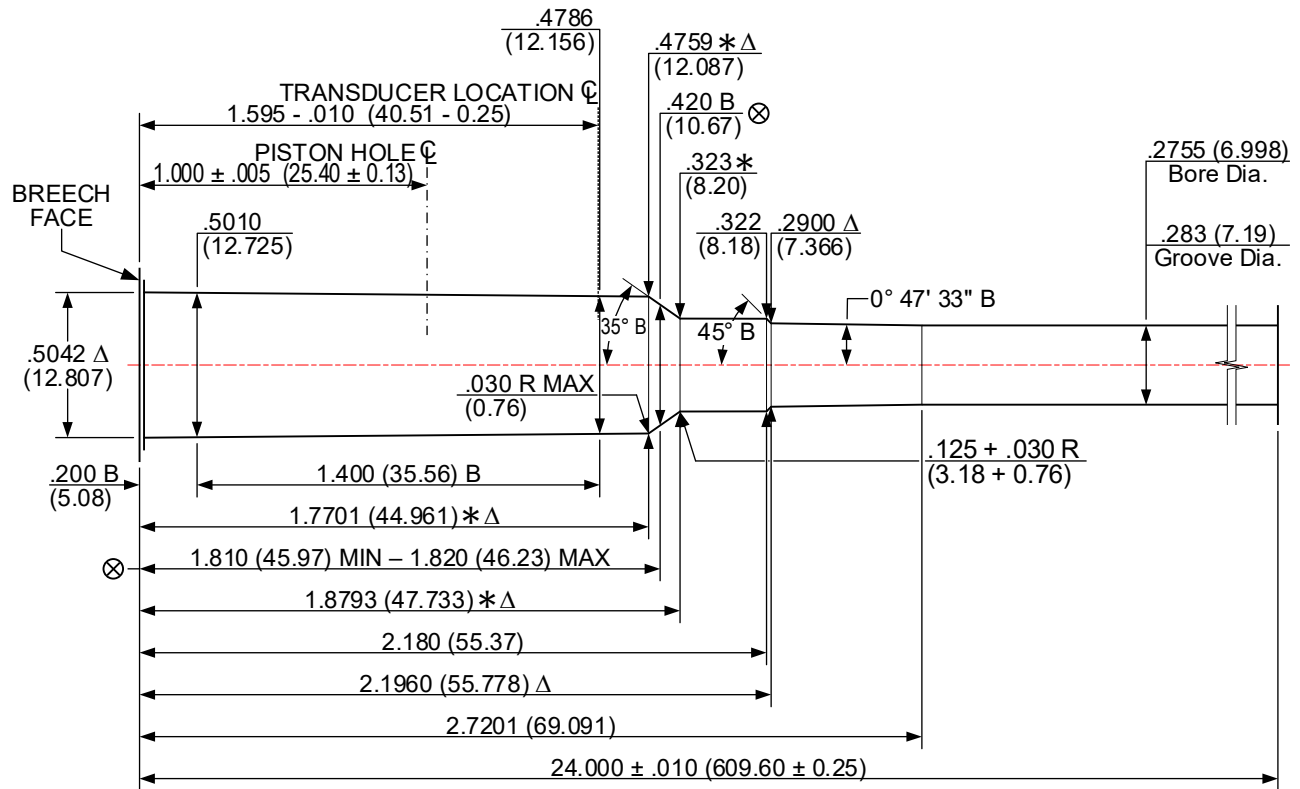

NUMBER OF GROOVES: 6
 WIDTH OF GROOVES: $.110 + .002$ (2.79 + 0.05)
 TWIST RATE: 10.00 (254.0) R.H.
 DIAMETER OF PISTON HOLE: $.206$ (5.23)
 TRANSDUCER DIAMETER: $.250$ (6.35)

LAND AND GROOVE DIMENSIONS TO BE
 WITHIN TOLERANCES THROUGHOUT
 LENGTH OF BARREL.

UNLESS OTHERWISE NOTED,
 ALL DIAMETERS $+0.005$ (0.013)
 LENGTH TOLERANCE $+ .005$ (0.13)

DO NOT SCALE FROM DRAWING

NOTES:

B = BASIC

Δ = REFERENCE DIMENSION

\otimes = HEADSPACE DIMENSION

* DIMENSIONS ARE TO INTERSECTIONS OF LINES

(XX.XX) = MILLIMETERS

ALL CALCULATIONS APPLY AT MAXIMUM MATERIAL CONDITION (MMC)

30 CARBINE [30 CARB]
V&P TEST BARREL

ISSUED: 05/20/1980

REVISED: 06/26/2023

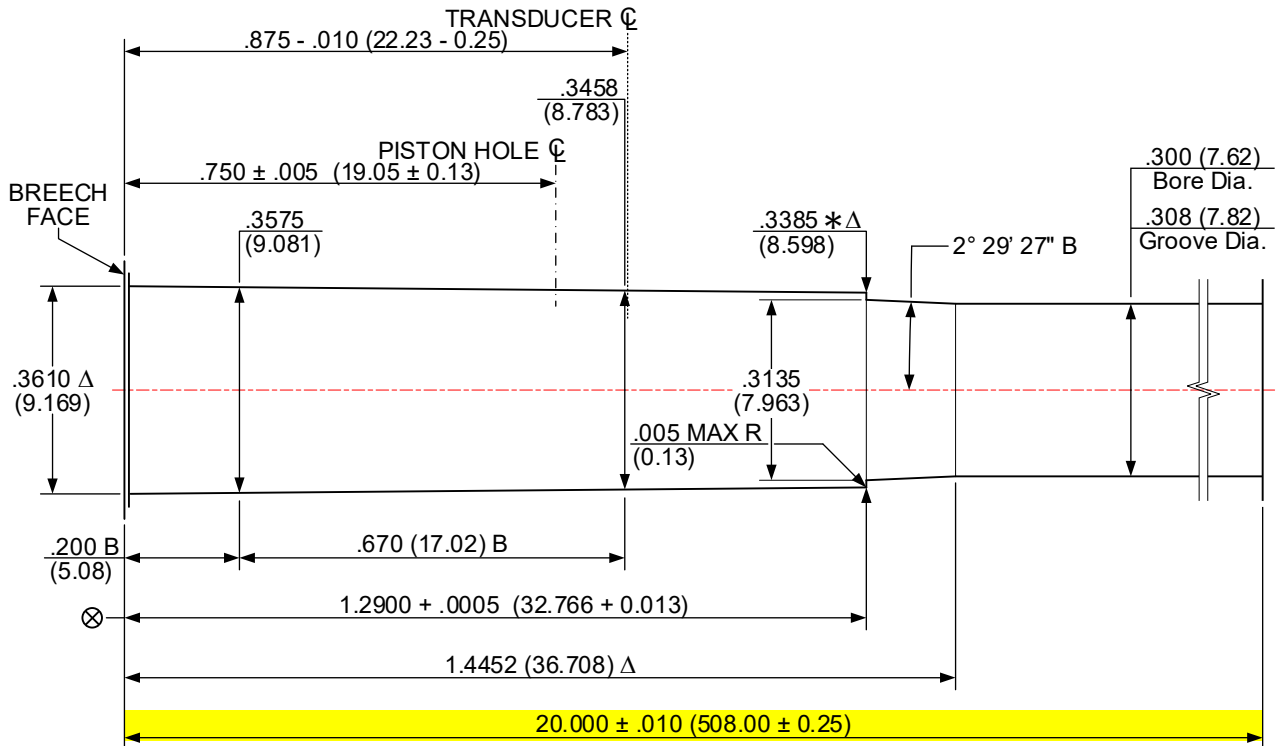

NUMBER OF GROOVES: 4
 WIDTH OF GROOVES: $.167 + .002$ (4.24 + 0.05)
 TWIST RATE: 20.00 (508.0) R.H.
 DIAMETER OF PISTON HOLE: $.206$ (5.23)
TRANSUDER DIAMETER: $.194$ (4.93)

LAND AND GROOVE DIMENSIONS TO BE
 WITHIN TOLERANCES THROUGHOUT
 LENGTH OF BARREL.

UNLESS OTHERWISE NOTED,
 ALL DIAMETERS $+ .0005$ (0.013)
 LENGTH TOLERANCE $+ .005$ (0.13)

DO NOT SCALE FROM DRAWING

NOTES:

B = BASIC

Δ = REFERENCE DIMENSION

⊗ = HEADSPACE DIMENSION

* DIMENSIONS ARE TO INTERSECTIONS OF LINES

(XX.XX) = MILLIMETERS

ALL CALCULATIONS APPLY AT MAXIMUM MATERIAL CONDITION (MMC)

30 Nosler [30 NOSLER]
 ISSUED: 01/19/2015 V&P TEST BARREL REVISED: 06/30/2023

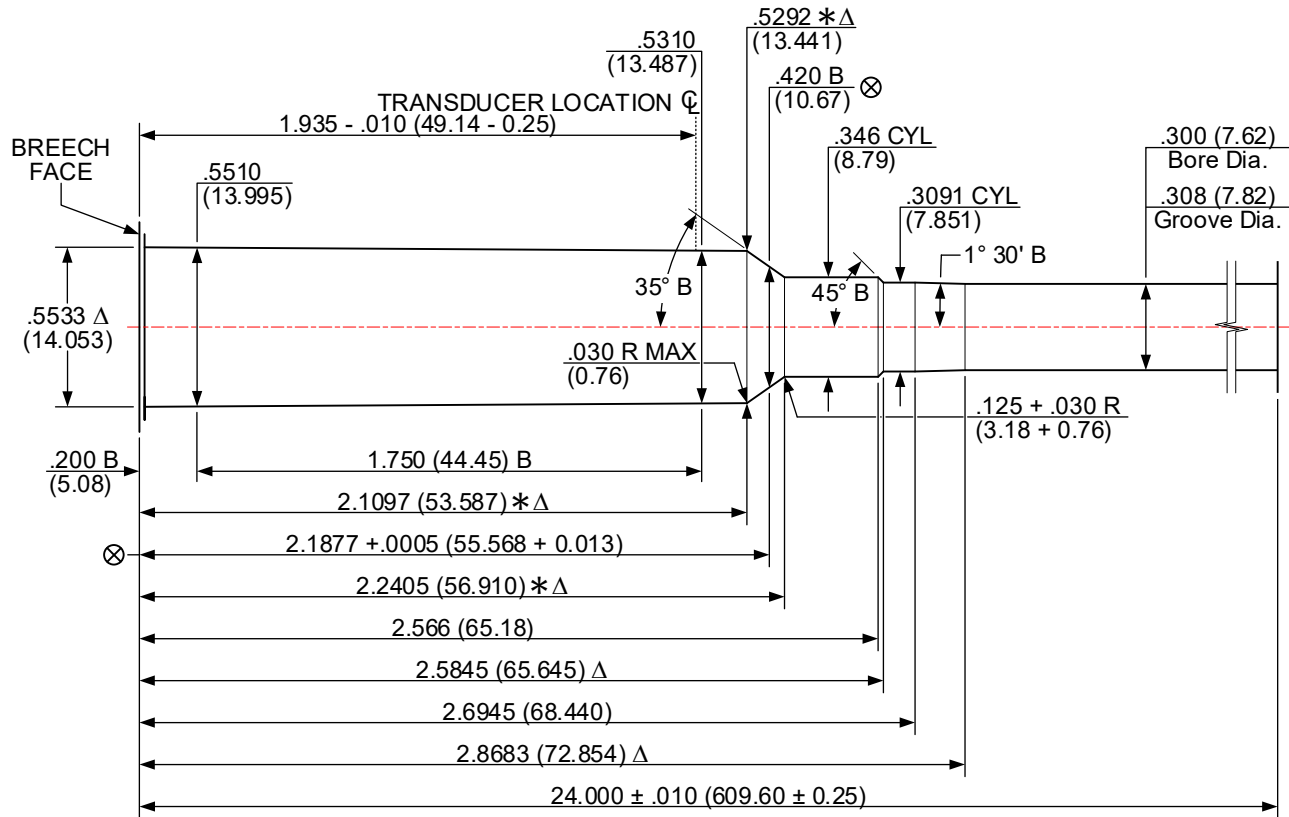

NUMBER OF GROOVES: 6
 WIDTH OF GROOVES: .110 + .002 (2.79 + 0.05)
 TWIST RATE: 10.00 (254.0) R.H.
 DIAMETER OF PISTON HOLE: Crusher pressures not established.
 TRANSDUCER DIAMETER: .250 (6.35)

LAND AND GROOVE DIMENSIONS TO BE
 WITHIN TOLERANCES THROUGHOUT
 LENGTH OF BARREL.

UNLESS OTHERWISE NOTED,
 ALL DIAMETERS +.0005 (0.013)
 LENGTH TOLERANCE + .005 (0.13)

DO NOT SCALE FROM DRAWING

NOTES:

B = BASIC

Δ = REFERENCE DIMENSION

⊗ = HEADSPACE DIMENSION

* DIMENSIONS ARE TO INTERSECTIONS OF LINES

(XX.XX) = MILLIMETERS

ALL CALCULATIONS APPLY AT MAXIMUM MATERIAL CONDITION (MMC)

30 REMINGTON AR [30 REM AR]
 ISSUED: 09/17/2009 V&P TEST BARREL REVISED: 07/05/2023

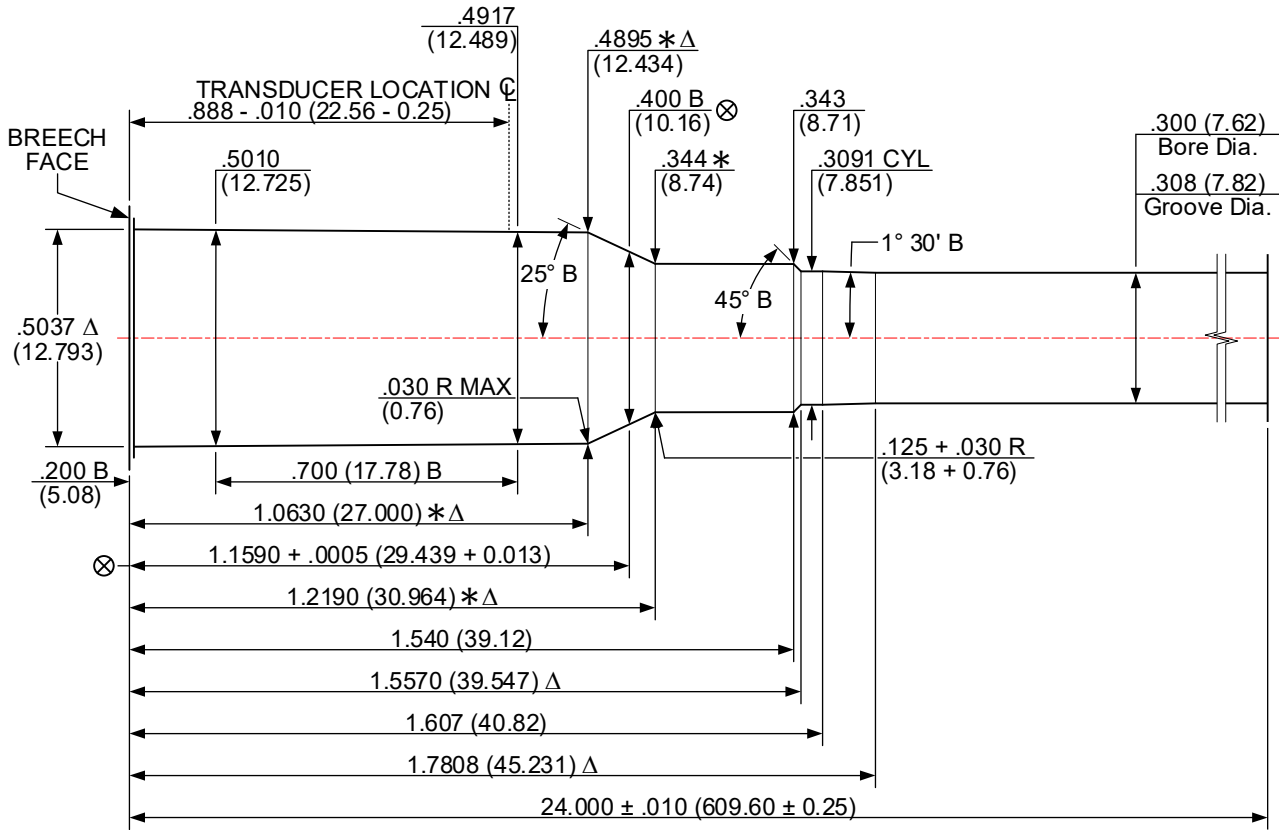

NUMBER OF GROOVES: 4
 WIDTH OF GROOVES: .176 + .002 (4.47 + 0.05)
 TWIST RATE: 10.00 (254.0) R.H.
 DIAMETER OF PISTON HOLE: Crusher pressures not established.
 TRANSDUCER DIAMETER: .250 (6.35)

LAND AND GROOVE DIMENSIONS TO BE
 WITHIN TOLERANCES THROUGHOUT
 LENGTH OF BARREL.

UNLESS OTHERWISE NOTED,
 ALL DIAMETERS +.0005 (0.013)
 LENGTH TOLERANCE + .005 (0.13)

DO NOT SCALE FROM DRAWING

NOTE:

B = BASIC

Δ = REFERENCE DIMENSION

⊗ = HEADSPACE DIMENSION

* DIMENSIONS ARE TO INTERSECTIONS OF LINES

(XX.XX) = MILLIMETERS

ALL CALCULATIONS APPLY AT MAXIMUM MATERIAL CONDITION (MMC)

30 THOMPSON CENTER [30 TC]
 ISSUED: 01/31/2008 V&P TEST BARREL REVISED: 07/05/2023

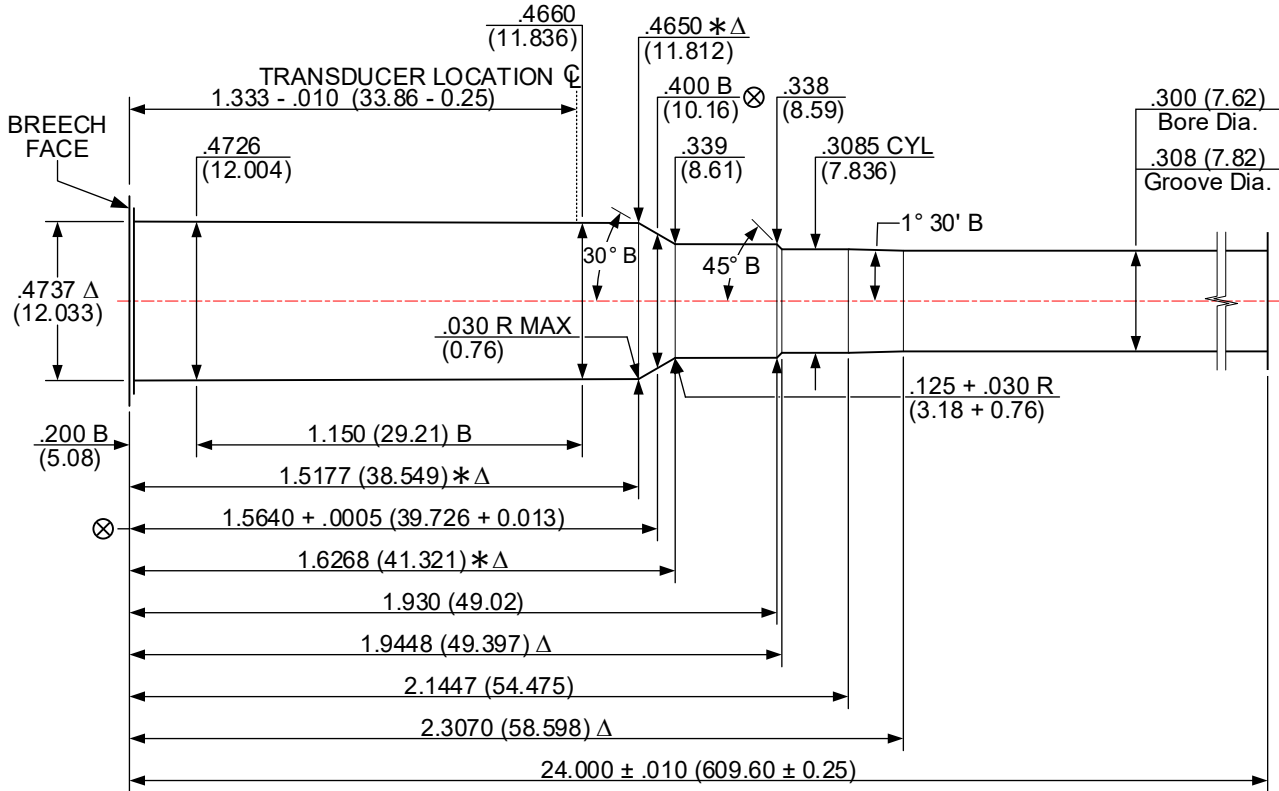

NUMBER OF GROOVES: 4
 WIDTH OF GROOVES: .176 + .002 (4.47 + 0.05)
 TWIST RATE: 12.00 (304.8) R.H.
 DIAMETER OF PISTON HOLE: Crusher pressures not established
 TRANSDUCER DIAMETER: .250 (6.35)

LAND AND GROOVE DIMENSIONS TO BE
 WITHIN TOLERANCES THROUGHOUT
 LENGTH OF BARREL.

UNLESS OTHERWISE NOTED,
 ALL DIAMETERS +.0005 (0.013)
 LENGTH TOLERANCE + .005 (0.13)

DO NOT SCALE FROM DRAWING

NOTES:

- B = BASIC
- * DIMENSIONS ARE TO INTERSECTIONS OF LINES
- ALL CALCULATIONS APPLY AT MAXIMUM MATERIAL CONDITION (MMC)
- Δ = REFERENCE DIMENSION
- ⊗ = HEADSPACE DIMENSION
- (XX.XX) = MILLIMETERS

30-06 SPRINGFIELD [30-06 SPRG]
 ISSUED: 05/20/1980 V&P TEST BARREL REVISED: 07/05/2023

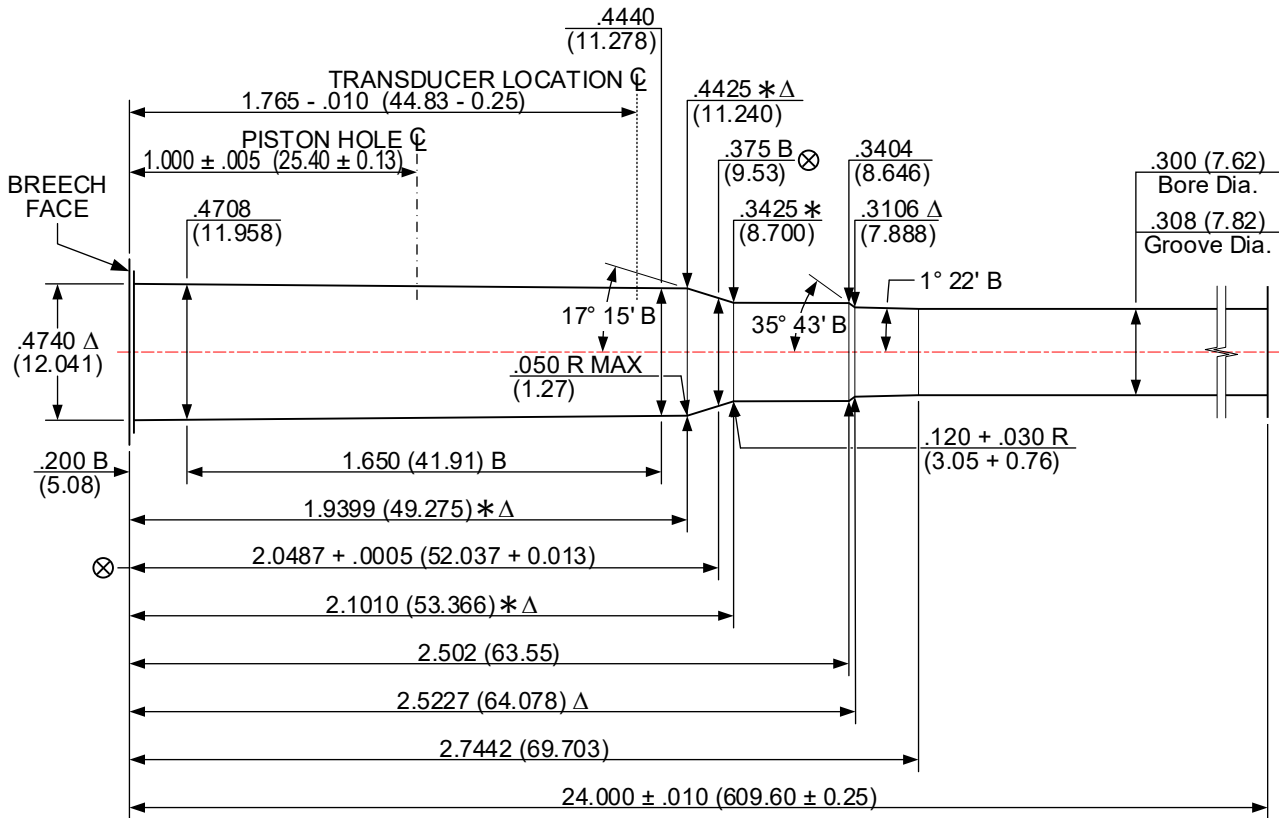

NUMBER OF GROOVES: 4
 WIDTH OF GROOVES: .1767 + .0020 (4.488 + 0.051)
 TWIST RATE: 10.00 (254.0) R.H.
 DIAMETER OF PISTON HOLE: .206 (5.23)
 TRANSDUCER DIAMETER: .250 (6.35)

LAND AND GROOVE DIMENSIONS TO BE
 WITHIN TOLERANCES THROUGHOUT
 LENGTH OF BARREL.

UNLESS OTHERWISE NOTED,
 ALL DIAMETERS +.0005 (0.013)
 LENGTH TOLERANCE + .005 (0.13)

DO NOT SCALE FROM DRAWING

NOTES:

B = BASIC

Δ = REFERENCE DIMENSION

⊗ = HEADSPACE DIMENSION

* DIMENSIONS ARE TO INTERSECTIONS OF LINES

(XX.XX) = MILLIMETERS

ALL CALCULATIONS APPLY AT MAXIMUM MATERIAL CONDITION (MMC)

30-30 WINCHESTER [30-30 WIN]
 ISSUED: 05/20/1980 V&P TEST BARREL REVISED: 07/05/2023

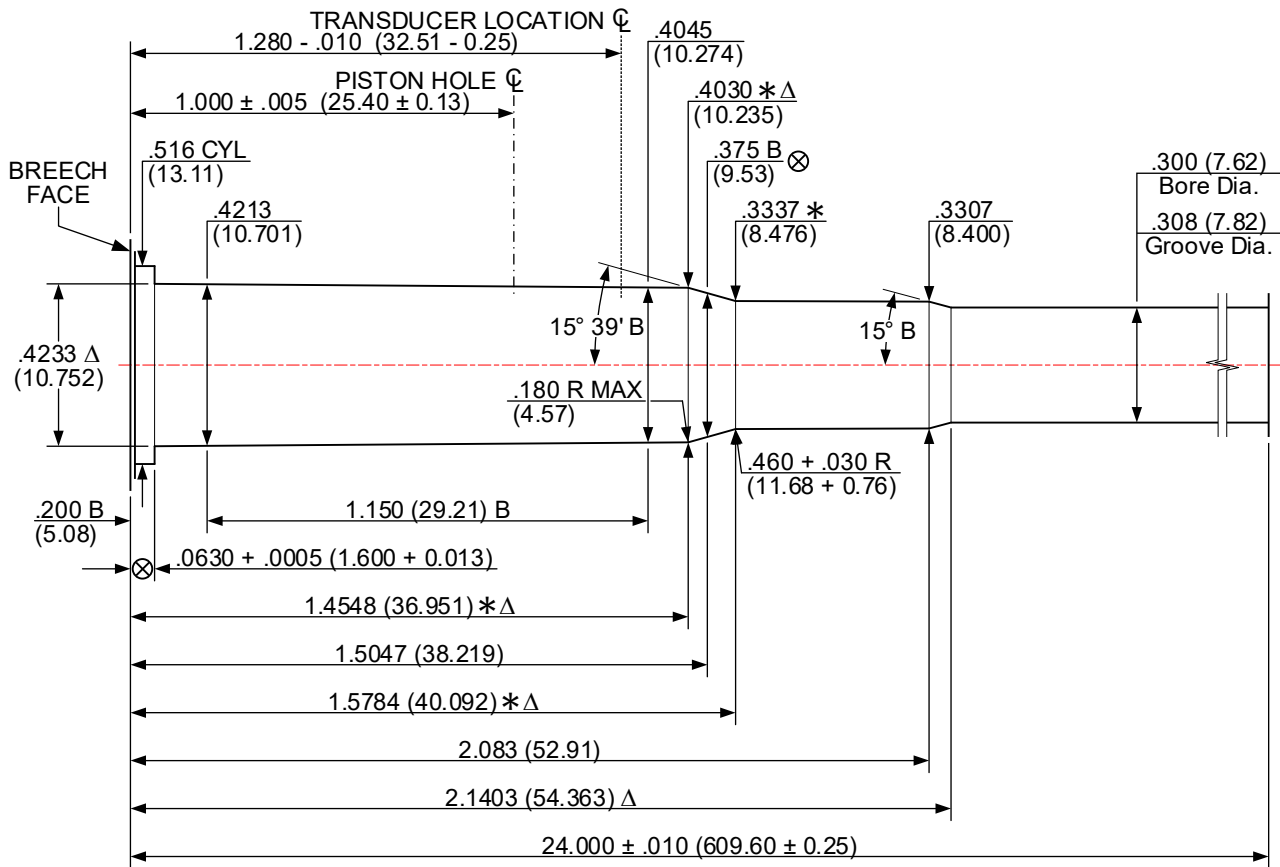

NUMBER OF GROOVES: 6
 WIDTH OF GROOVES: .0942 + .0020 (2.393 + 0.051)
 TWIST RATE: 12.00 (304.8) R.H.
 DIAMETER OF PISTON HOLE: .206 (5.23)
 TRANSDUCER DIAMETER: .250 (6.53)

LAND AND GROOVE DIMENSIONS TO BE
 WITHIN TOLERANCES THROUGHOUT
 LENGTH OF BARREL.

UNLESS OTHERWISE NOTED,
 ALL DIAMETERS +.0005 (0.013)
 LENGTH TOLERANCE + .005 (0.13)

DO NOT SCALE FROM DRAWING

NOTES:
 B = BASIC Δ = REFERENCE DIMENSION ⊗ = HEADSPACE DIMENSION
 * DIMENSIONS ARE TO INTERSECTIONS OF LINES (XX.XX) = MILLIMETERS
 ALL CALCULATIONS APPLY AT MAXIMUM MATERIAL CONDITION (MMC)

30-40 Krag [30-40 Krag]
 ISSUED: 05/20/1980 V&P TEST BARREL REVISED: 07/05/2023

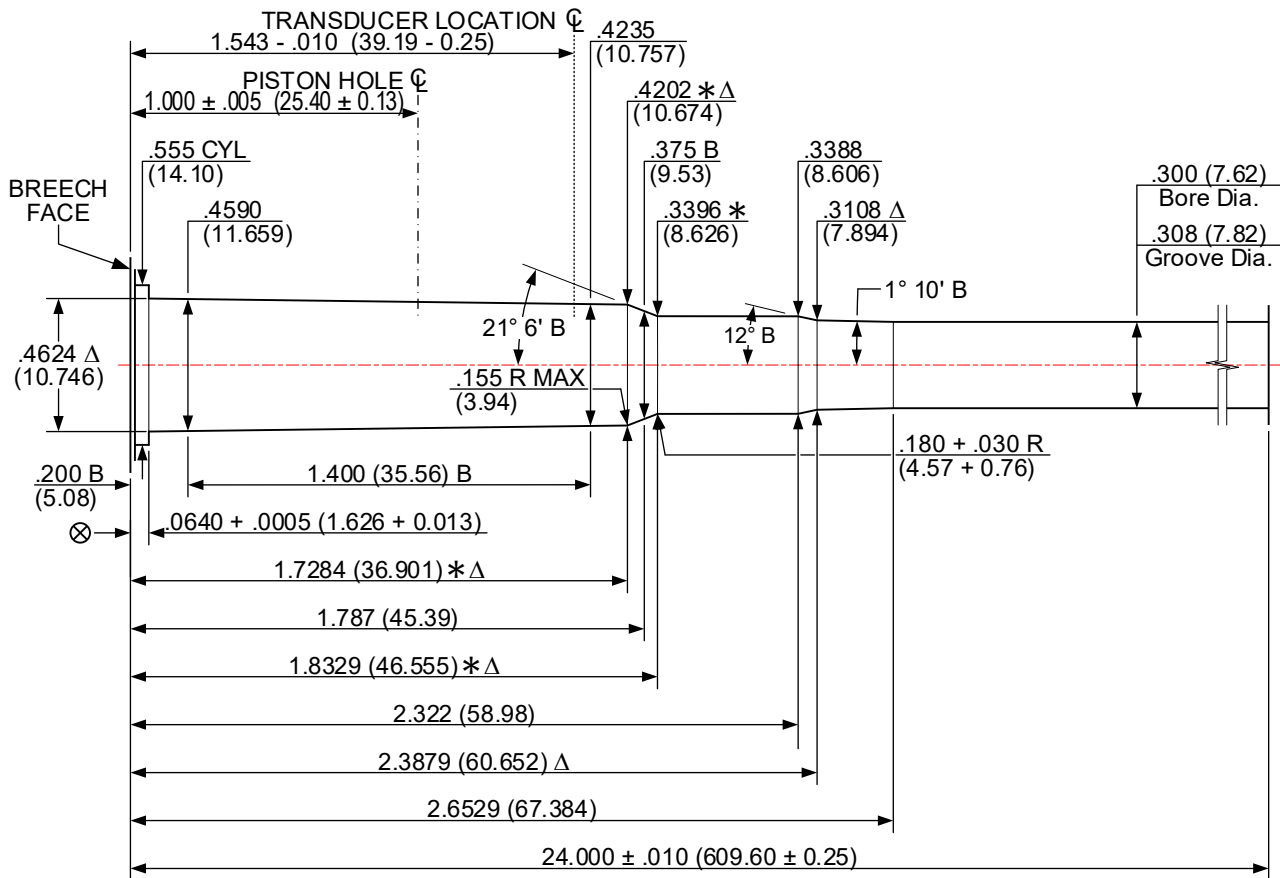

NUMBER OF GROOVES: 6
 WIDTH OF GROOVES: .094 + .002 (2.39 + 0.05)
 TWIST RATE: 10.00 (254.0) R.H.
 DIAMETER OF PISTON HOLE: .206 (5.23)
 TRANSDUCER DIAMETER: .250 (6.53)

LAND AND GROOVE DIMENSIONS TO BE
 WITHIN TOLERANCES THROUGHOUT
 LENGTH OF BARREL.

UNLESS OTHERWISE NOTED,
 ALL DIAMETERS +.0005 (0.013)
 LENGTH TOLERANCE + .005 (0.13)

DO NOT SCALE FROM DRAWING

NOTES:
 B = BASIC Δ = REFERENCE DIMENSION ⊗ = HEADSPACE DIMENSION
 * DIMENSIONS ARE TO INTERSECTIONS OF LINES (XX.XX) = MILLIMETERS
 ALL CALCULATIONS APPLY AT MAXIMUM MATERIAL CONDITION (MMC)

300 AAC BLACKOUT [300 BLK]
 ISSUED: 01/20/2011 V&P TEST BARREL REVISED: 07/05/2023

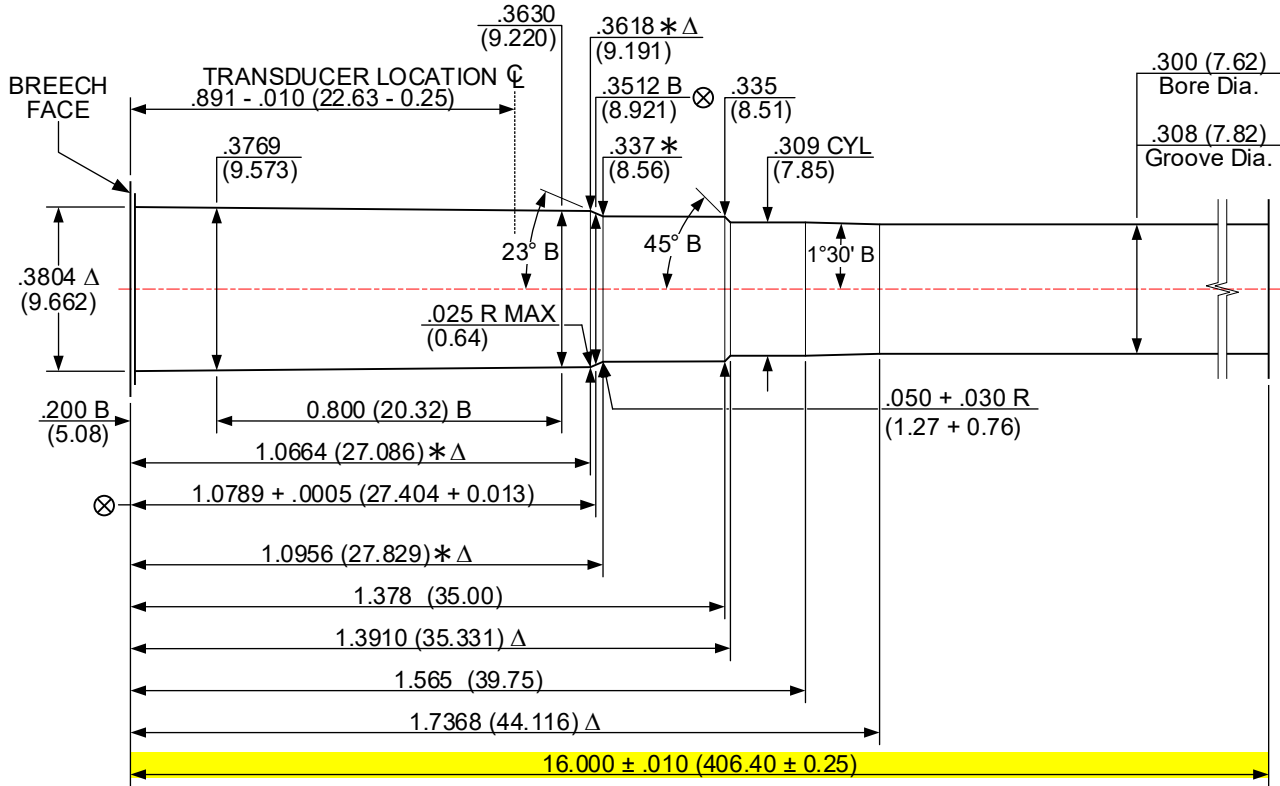

NUMBER OF GROOVES: 5
 WIDTH OF GROOVES: .146 + .002 (3.71 + 0.05)
 TWIST RATE: 8.00 (203.2) R.H.
 DIAMETER OF PISTON HOLE: Crusher pressures not established.
 TRANSDUCER DIAMETER: .250 (6.35)

LAND AND GROOVE DIMENSIONS TO BE
 WITHIN TOLERANCES THROUGHOUT
 LENGTH OF BARREL.

UNLESS OTHERWISE NOTED,
 ALL DIAMETERS +.0005 (0.013)
 LENGTH TOLERANCE + .005 (0.13)

DO NOT SCALE FROM DRAWING

NOTES:

B = BASIC

Δ = REFERENCE DIMENSION

⊗ = HEADSPACE DIMENSION

* DIMENSIONS ARE TO INTERSECTIONS OF LINES

(XX.XX) = MILLIMETERS

ALL CALCULATIONS APPLY AT MAXIMUM MATERIAL CONDITION (MMC)

300 HAM'R [300 HAMR] V&P TEST BARREL
 ISSUED: 01/20/2020 V&P TEST BARREL REVISED: 07/05/2023

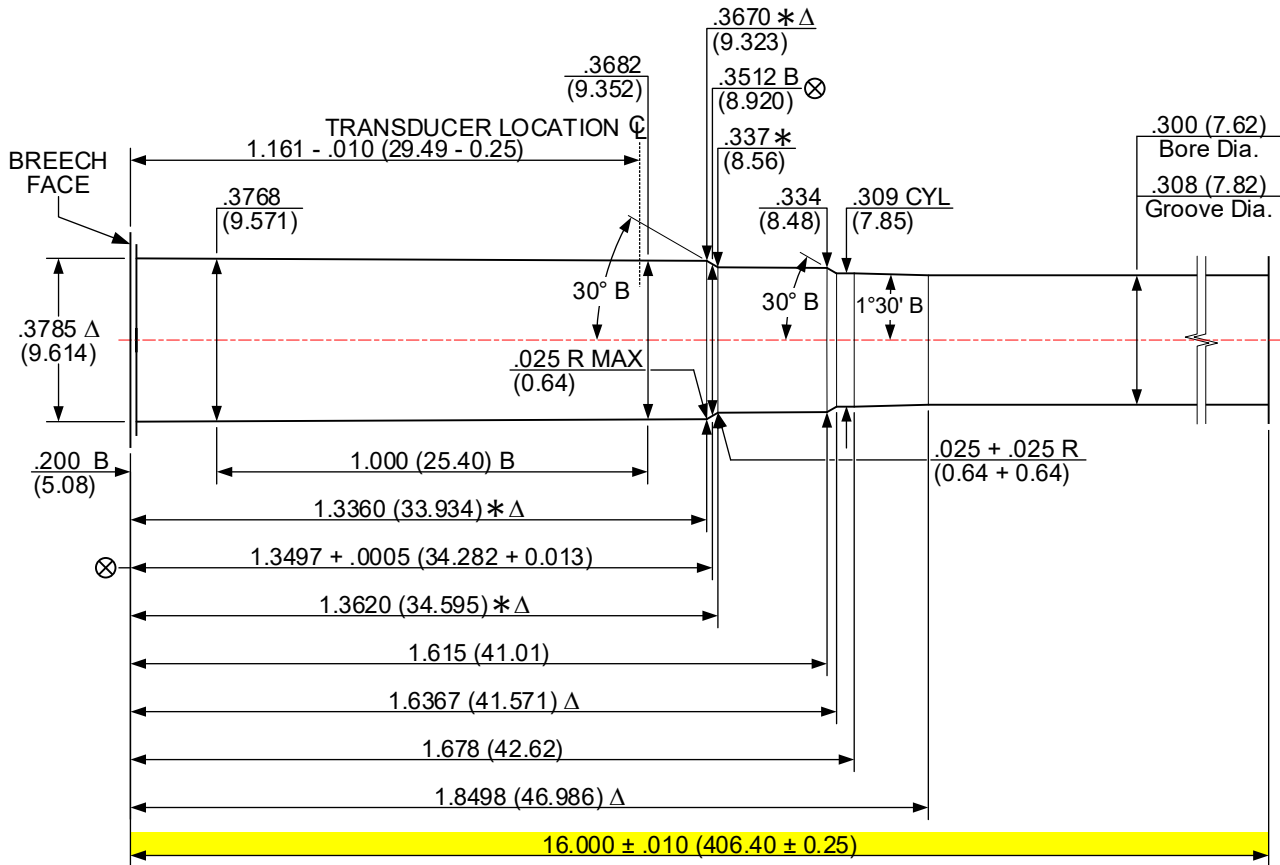

NUMBER OF GROOVES: 4
 WIDTH OF GROOVES: .176 + .002 (4.47 + 0.05)
 TWIST RATE: 12.00 (304.8) R.H.
 DIAMETER OF PISTON HOLE: Crusher pressures not established.
 TRANSDUCER DIAMETER: .250 (6.35)

LAND AND GROOVE DIMENSIONS TO BE
 WITHIN TOLERANCES THROUGHOUT
 LENGTH OF BARREL.

UNLESS OTHERWISE NOTED,
 ALL DIAMETERS +.0005 (0.013)
 LENGTH TOLERANCE + .005 (0.13)

DO NOT SCALE FROM DRAWING

NOTE:

B = BASIC

Δ = REFERENCE DIMENSION

⊗ = HEADSPACE DIMENSION

* DIMENSIONS ARE TO INTERSECTIONS OF LINES

(XX.XX) = MILLIMETERS

ALL CALCULATIONS APPLY AT MAXIMUM MATERIAL CONDITION (MMC)

300 HOLLAND & HOLLAND MAGNUM [300 H&H MAG]
 ISSUED: 05/20/1980 V&P TEST BARREL REVISED: 07/05/2023

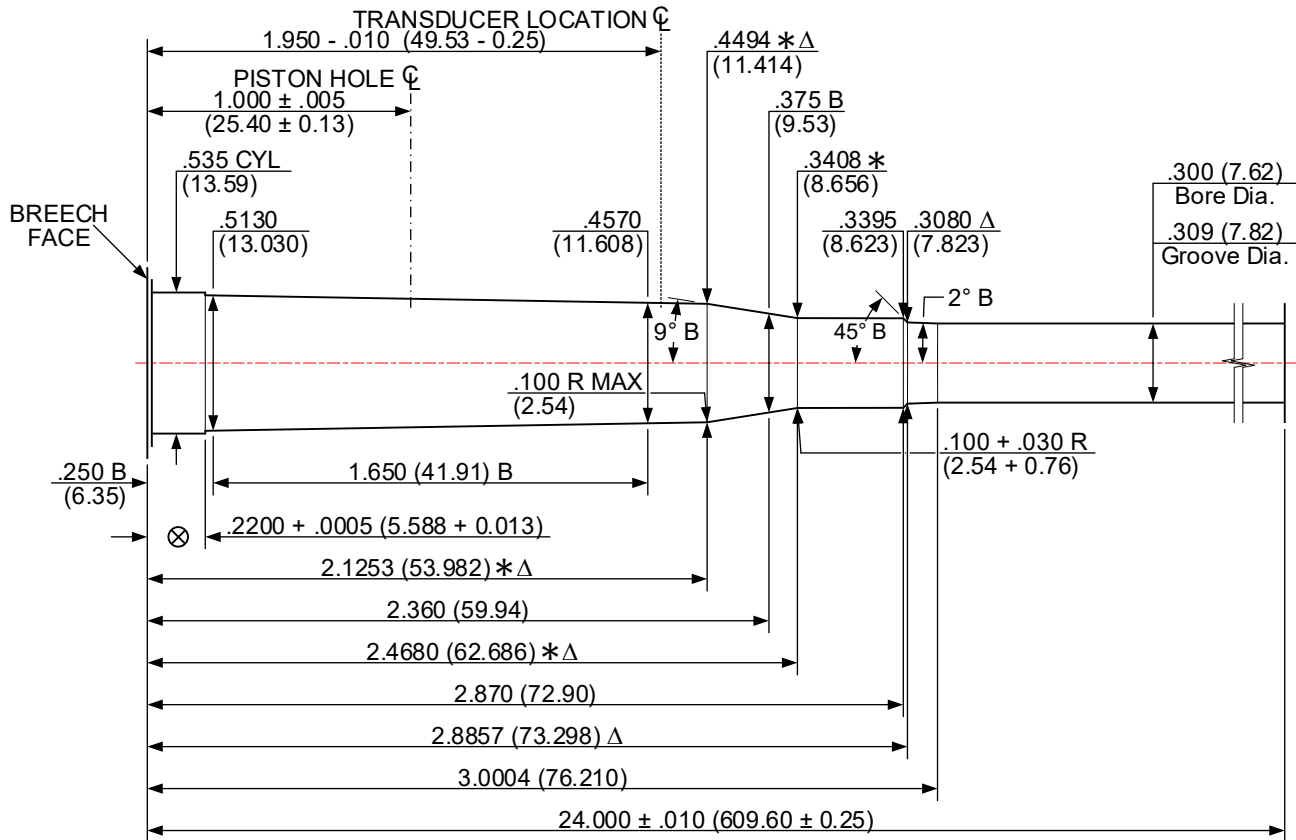

NUMBER OF GROOVES: 4
 WIDTH OF GROOVES: $.176 + .002$ (4.47 + 0.05)
 TWIST RATE: 10.00 (254.0) R.H.
 DIAMETER OF PISTON HOLE: $.206$ (5.23)
 TRANSDUCER DIAMETER: $.250$ (6.35)

LAND AND GROOVE DIMENSIONS TO BE
 WITHIN TOLERANCES THROUGHOUT
 LENGTH OF BARREL.

UNLESS OTHERWISE NOTED,
 ALL DIAMETERS $+ .0005$ (0.013)
 LENGTH TOLERANCE $+ .005$ (0.13)

DO NOT SCALE FROM DRAWING

NOTES:
 B = BASIC Δ = REFERENCE DIMENSION \otimes = HEADSPACE DIMENSION
 * DIMENSIONS ARE TO INTERSECTIONS OF LINES (XX.XX) = MILLIMETERS
 ALL CALCULATIONS APPLY AT MAXIMUM MATERIAL CONDITION (MMC)

300 NORMA MAGNUM [300 NM]
 ISSUED: 09/23/2020 V&P TEST BARREL REVISED: 10/11/2024

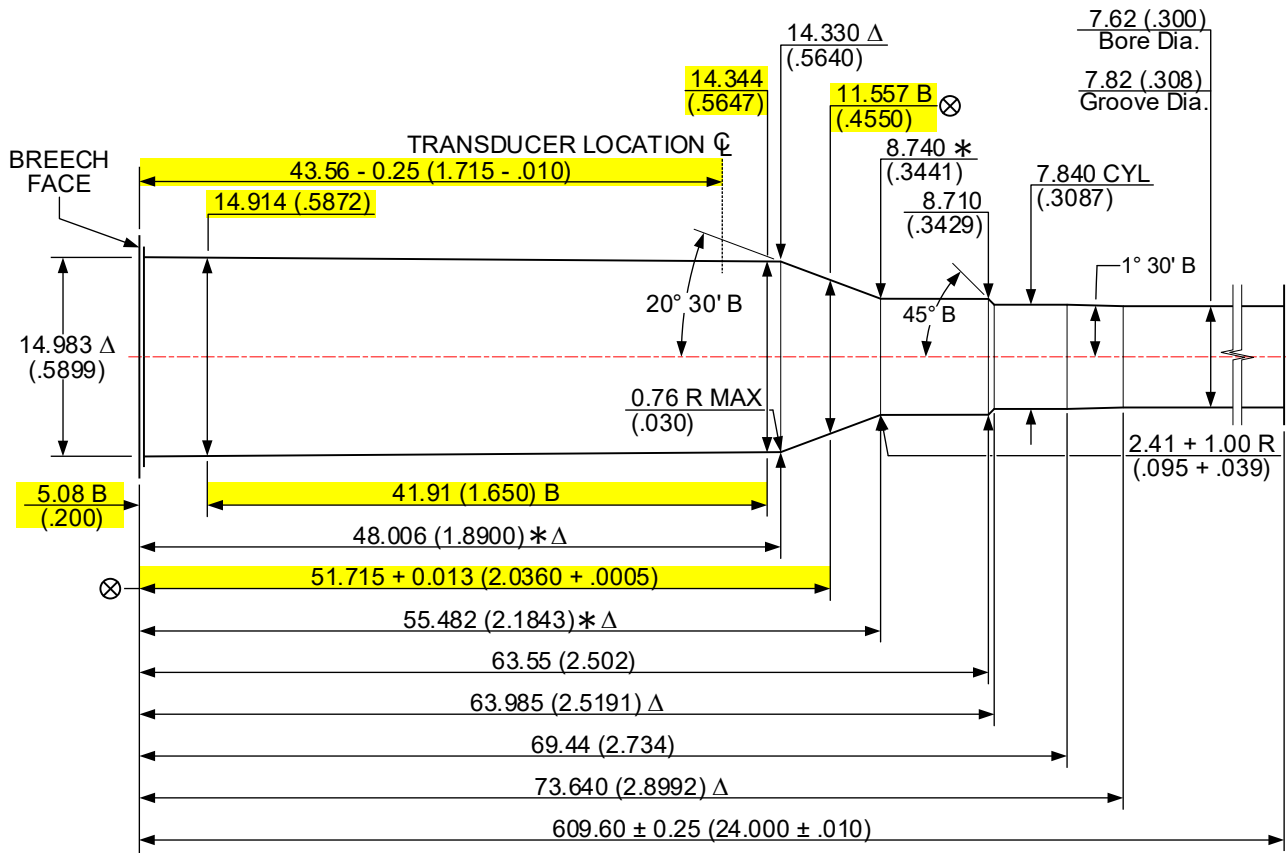

HIGHLIGHTED DIMENSIONS HAVE NO CORRESPONDING C.I.P. ANALOG. THE METRIC UNITS FOR THESE ARE THE ORIGINAL VALUES; U.S. CUSTOMARY VALUES ARE CALCULATED AND ROUNDED.

NUMBER OF GROOVES: 4
 WIDTH OF GROOVES: 4.47+0.05 (.176+.002)
 TWIST RATE: 229.0 (9.02) RH
 DIAMETER OF PISTON HOLE: Crusher pressures not established
 TRANSDUCER DIAMETER: 6.35 (.250)

LAND AND GROOVE DIMENSIONS TO BE WITHIN TOLERANCES THROUGHOUT LENGTH OF BARREL.

UNLESS OTHERWISE NOTED, ALL DIAMETERS +0.013 (.0005) LENGTH TOLERANCE +0.13 (.005)

DO NOT SCALE FROM DRAWING

NOTES:

B = BASIC

Δ = REFERENCE DIMENSION

⊗ = HEADSPACE DIMENSION

* DIMENSIONS ARE TO INTERSECTIONS OF LINES

(XX.XX) = MILLIMETERS

ALL CALCULATIONS APPLY AT MAXIMUM MATERIAL CONDITION (MMC)

300 PRECISION RIFLE CARTRIDGE [300 PRC]
 ISSUED: 06/13/2018 V&P TEST BARREL REVISED: 07/10/2023

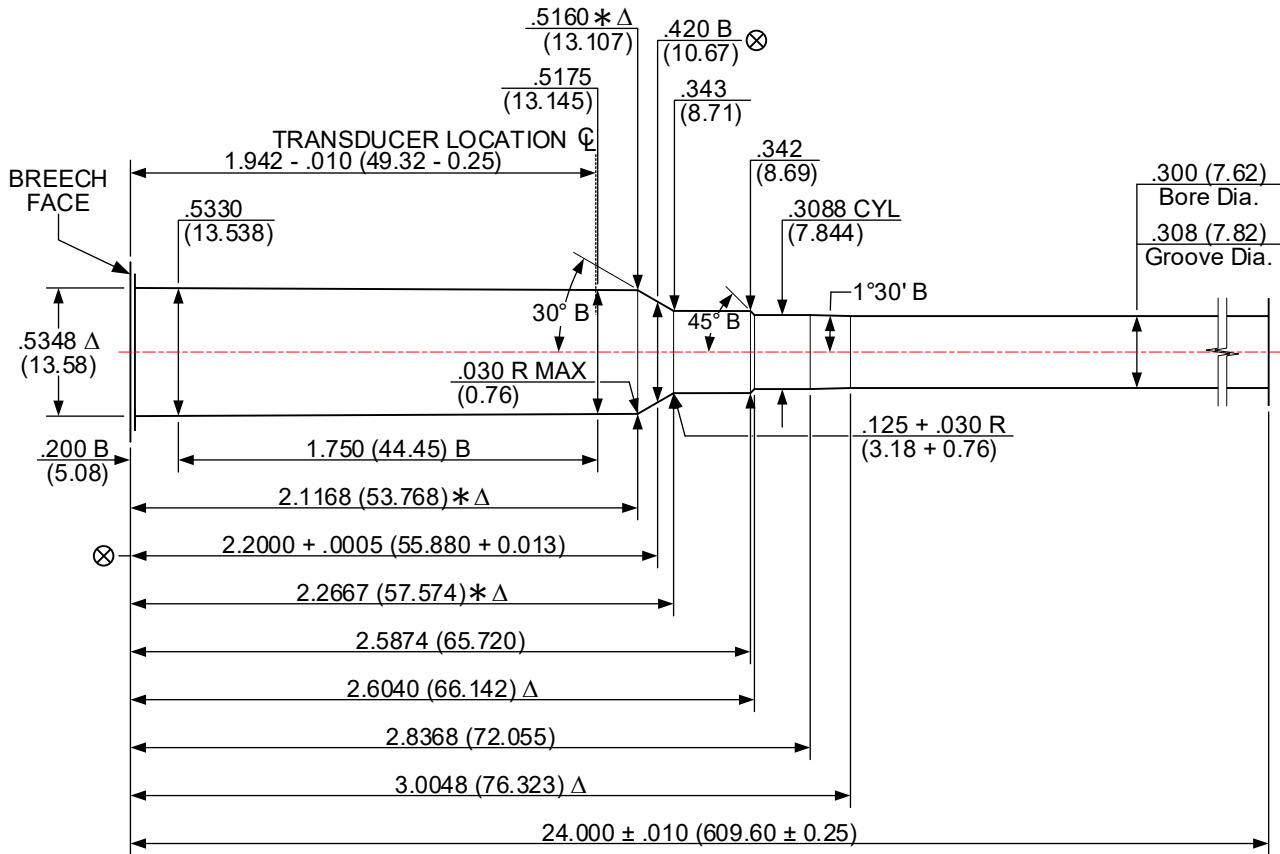

NUMBER OF GROOVES: 6
 WIDTH OF GROOVES: .115 + .002 (2.92 + 0.05)
 TWIST RATE: 8.50 (215.9) R.H.
 DIAMETER OF PISTON HOLE: Crusher pressures not established.
 TRANSDUCER DIAMETER: .250 (6.35)

LAND AND GROOVE DIMENSIONS TO BE
 WITHIN TOLERANCES THROUGHOUT
 LENGTH OF BARREL.

UNLESS OTHERWISE NOTED,
 ALL DIAMETERS +.0005 (0.013)
 LENGTH TOLERANCE + .005 (0.13)

DO NOT SCALE FROM DRAWING

NOTES:

B = BASIC

Δ = REFERENCE DIMENSION

⊗ = HEADSPACE DIMENSION

* DIMENSIONS ARE TO INTERSECTIONS OF LINES

(XX.XX) = MILLIMETERS

ALL CALCULATIONS APPLY AT MAXIMUM MATERIAL CONDITION (MMC)

300 REMINGTON SHORT ACTION ULTRA MAGNUM [300 REM SA ULTRA MAGNUM]

ISSUED: 02/01/2002

V&P TEST BARREL

REVISED: 07/10/2023

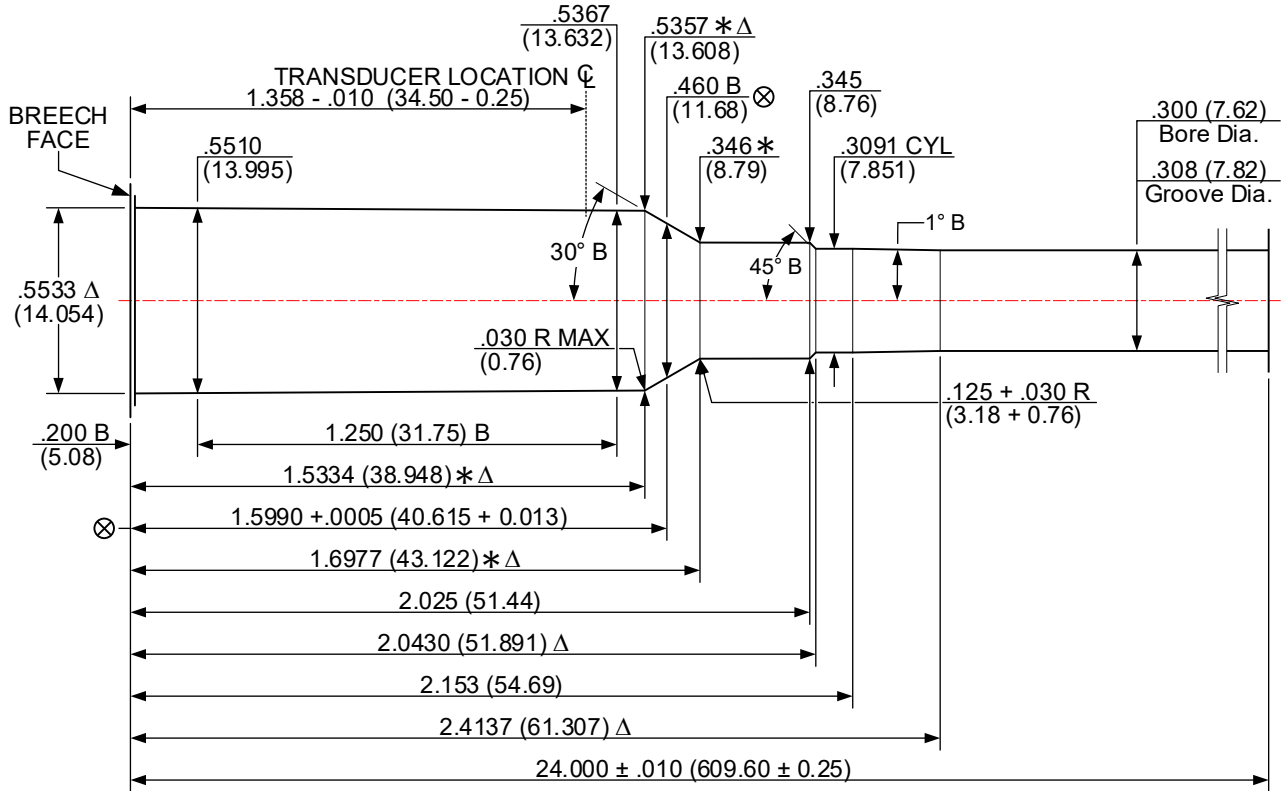

NUMBER OF GROOVES: 6

WIDTH OF GROOVES: .110 + .002 (2.79 + 0.05)

TWIST RATE: 10.00 (254.0) R.H.

DIAMETER OF PISTON HOLE: Crusher pressures not established

TRANSDUCER DIAMETER: .250 (6.35)

LAND AND GROOVE DIMENSIONS TO BE
 WITHIN TOLERANCES THROUGHOUT
 LENGTH OF BARREL.

UNLESS OTHERWISE NOTED,
 ALL DIAMETERS +.0005 (0.013)
 LENGTH TOLERANCE + .005 (0.13)

DO NOT SCALE FROM DRAWING

NOTES:

B = BASIC

Δ = REFERENCE DIMENSION

⊗ = HEADSPACE DIMENSION

* DIMENSIONS ARE TO INTERSECTIONS OF LINES

(XX.XX) = MILLIMETERS

ALL CALCULATIONS APPLY AT MAXIMUM MATERIAL CONDITION (MMC)

300 REMINGTON ULTRA MAGNUM [300 REM ULTRA MAG]
 ISSUED: 01/07/1999 V&P TEST BARREL REVISED: 07/10/2023

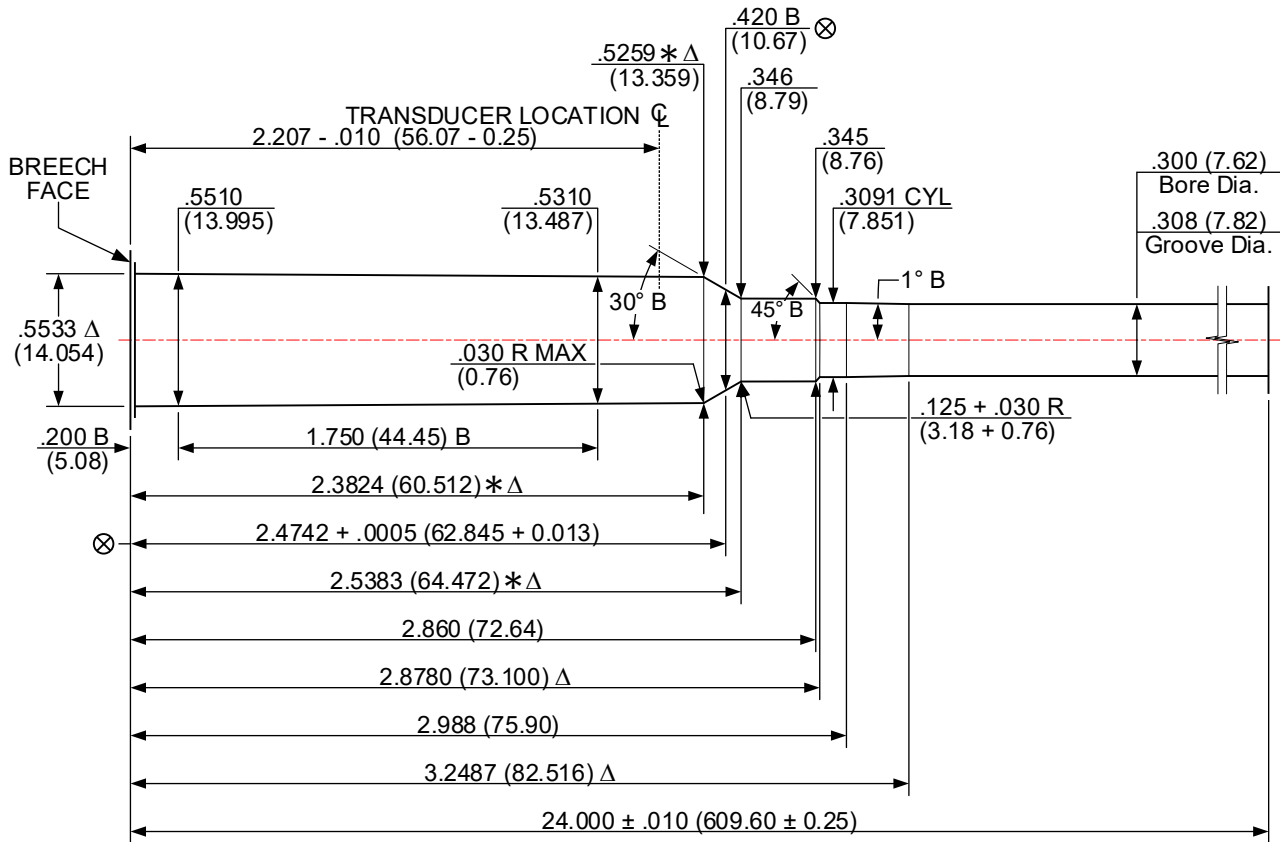

NUMBER OF GROOVES: 6
 WIDTH OF GROOVES: .115 + .002 (2.92 + 0.05)
 TWIST RATE: 10.00 (254.0) R.H.
 DIAMETER OF PISTON HOLE: Crusher pressure not established.
 TRANSDUCER DIAMETER: .250 (6.35)

LAND AND GROOVE DIMENSIONS TO BE
 WITHIN TOLERANCES THROUGHOUT
 LENGTH OF BARREL.

UNLESS OTHERWISE NOTED,
 ALL DIAMETERS +.0005 (0.013)
 LENGTH TOLERANCE + .005 (0.13)

DO NOT SCALE FROM DRAWING

NOTES:

B = BASIC

Δ = REFERENCE DIMENSION

⊗ = HEADSPACE DIMENSION

* DIMENSIONS ARE TO INTERSECTIONS OF LINES

(XX.XX) = MILLIMETERS

ALL CALCULATIONS APPLY AT MAXIMUM MATERIAL CONDITION (MMC)

300 RUGER COMPACT MAGNUM [300 RCM]

ISSUED: 12/30/2008

V&P TEST BARREL

REVISED: 07/10/2023

Note - The User's attention is called to the fact that an assurance has been provided by a person claiming to own intellectual property rights that will be necessarily infringed by use of this Standard, and that such person is prepared to grant non-exclusive licenses in connection with such intellectual property rights on reasonable terms and conditions, which may be royalty bearing or royalty free as shall be negotiated, and free of any demonstrably unfair discrimination. Further information may be obtained from SAAMI's Technical Office.

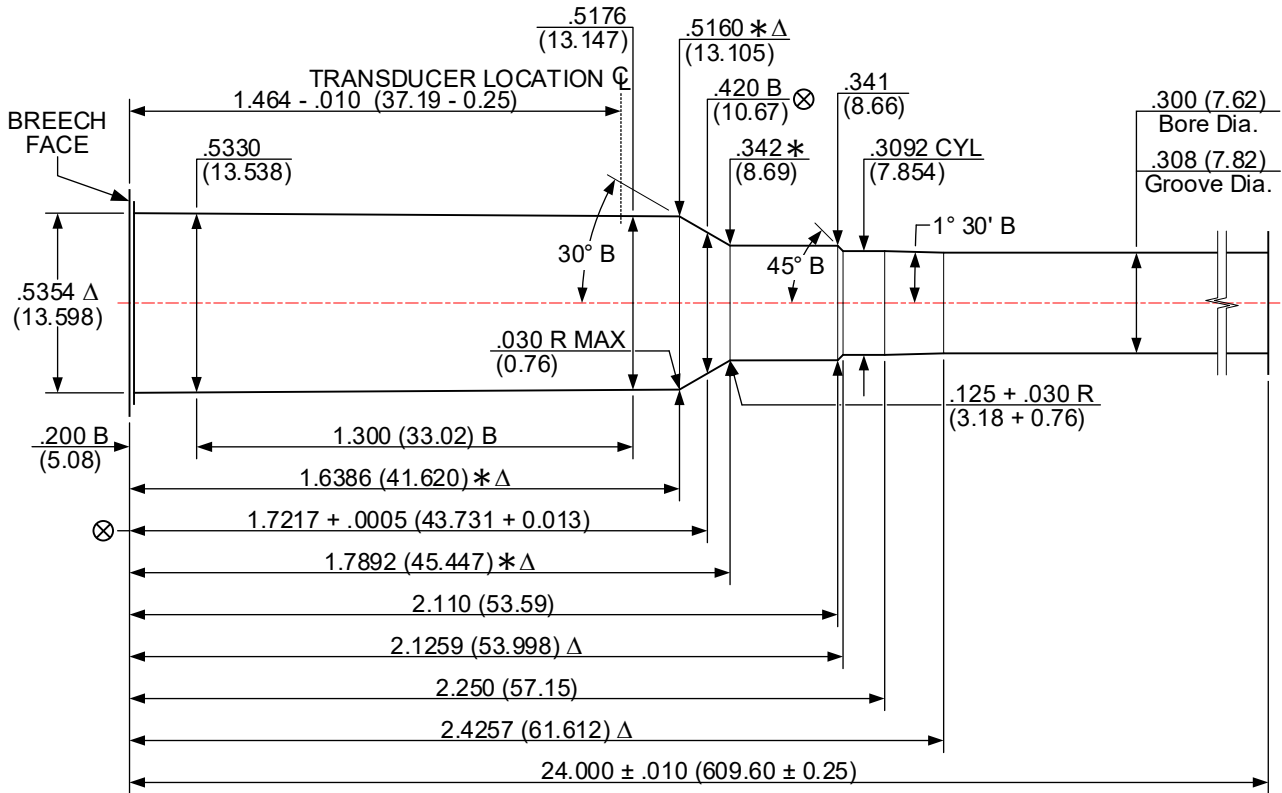

NUMBER OF GROOVES: 6

WIDTH OF GROOVES: .110 + .002 (2.79 + 0.051)

TWIST RATE: 10.00 (254.0) R.H.

DIAMETER OF PISTON HOLE: Crusher pressures not established

TRANSDUCER DIAMETER: .250 (6.35)

LAND AND GROOVE DIMENSIONS TO BE
 WITHIN TOLERANCES THROUGHOUT
 LENGTH OF BARREL.

UNLESS OTHERWISE NOTED,
 ALL DIAMETERS +.0005 (0.013)
 LENGTH TOLERANCE + .005 (0.13)

DO NOT SCALE FROM DRAWING

NOTES:

B = BASIC

Δ = REFERENCE DIMENSION

⊗ = HEADSPACE DIMENSION

* DIMENSIONS ARE TO INTERSECTIONS OF LINES

(XX.XX) = MILLIMETERS

ALL CALCULATIONS APPLY AT MAXIMUM MATERIAL CONDITION (MMC)

300 SAVAGE [300 SAV]
ISSUED: 05/20/1980 **V&P TEST BARREL** **REVISED: 07/10/2023**

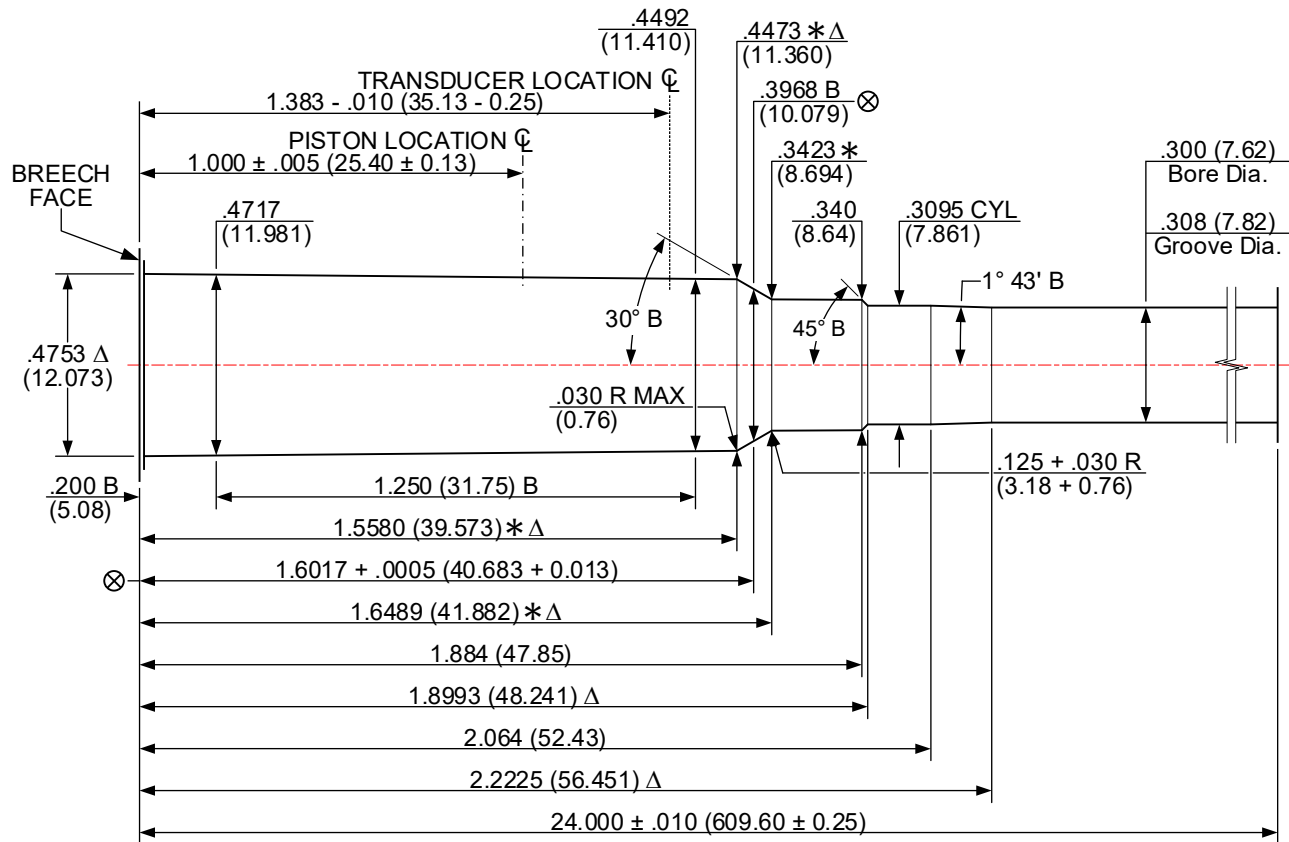

NUMBER OF GROOVES: 6
 WIDTH OF GROOVES: .095 + .002 (2.41 + 0.05)
 TWIST RATE: 12.00 (304.8) R.H.
 DIAMETER OF PISTON HOLE: .206 (5.23)
 TRANSDUCER DIAMETER: .250 (6.35)

LAND AND GROOVE DIMENSIONS TO BE
 WITHIN TOLERANCES THROUGHOUT
 LENGTH OF BARREL.

UNLESS OTHERWISE NOTED,
 ALL DIAMETERS +.0005 (0.013)
 LENGTH TOLERANCE + .005 (0.13)

DO NOT SCALE FROM DRAWING

NOTES:

B = BASIC

Δ = REFERENCE DIMENSION

⊗ = HEADSPACE DIMENSION

* DIMENSIONS ARE TO INTERSECTIONS OF LINES

(XX.XX) = MILLIMETERS

ALL CALCULATIONS APPLY AT MAXIMUM MATERIAL CONDITION (MMC)

300 WEATHERBY MAGNUM [300 WBY MAG]
 ISSUED: 02/01/1990 V&P TEST BARREL REVISED: 01/21/2024

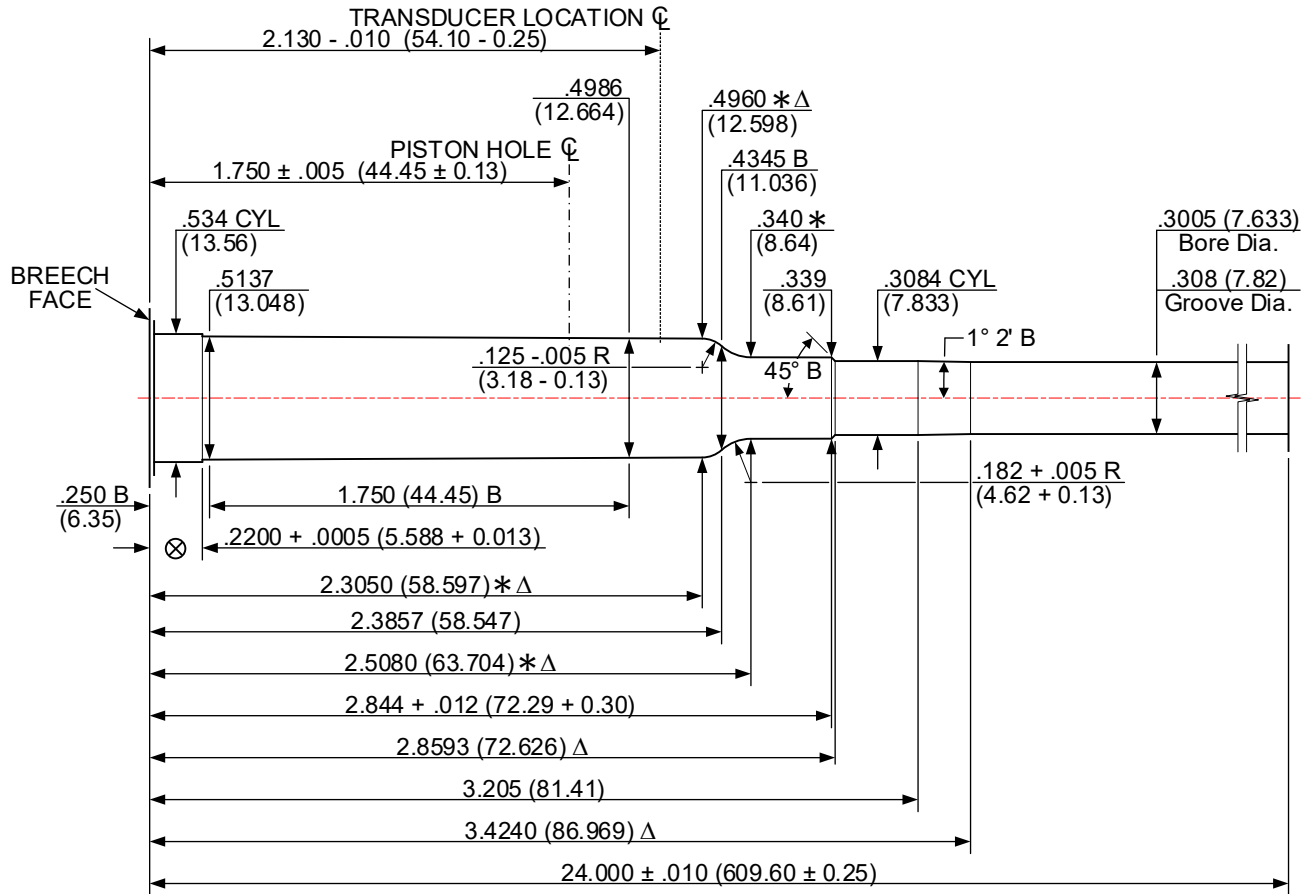

NUMBER OF GROOVES: 6
 WIDTH OF GROOVES: .118 + .002 (3.00 + 0.05)
 TWIST RATE: 10.00 (254.0) R.H.
 DIAMETER OF PISTON HOLE: .206 (5.23)
 TRANSDUCER DIAMETER: .250 (6.35)

LAND AND GROOVE DIMENSIONS TO BE
 WITHIN TOLERANCES THROUGHOUT
 LENGTH OF BARREL.

UNLESS OTHERWISE NOTED,
 ALL DIAMETERS +.0005 (0.013)
 LENGTH TOLERANCE + .005 (0.13)

DO NOT SCALE FROM DRAWING

NOTES:

B = BASIC

Δ = REFERENCE DIMENSION

\otimes = HEADSPACE DIMENSION

* DIMENSIONS ARE TO INTERSECTIONS OF LINES

(XX.XX) = MILLIMETERS

ALL CALCULATIONS APPLY AT MAXIMUM MATERIAL CONDITION (MMC)

300 WINCHESTER MAGNUM [300 WIN MAG]
 ISSUED: 05/20/1980 V&P TEST BARREL REVISED: 07/11/2023

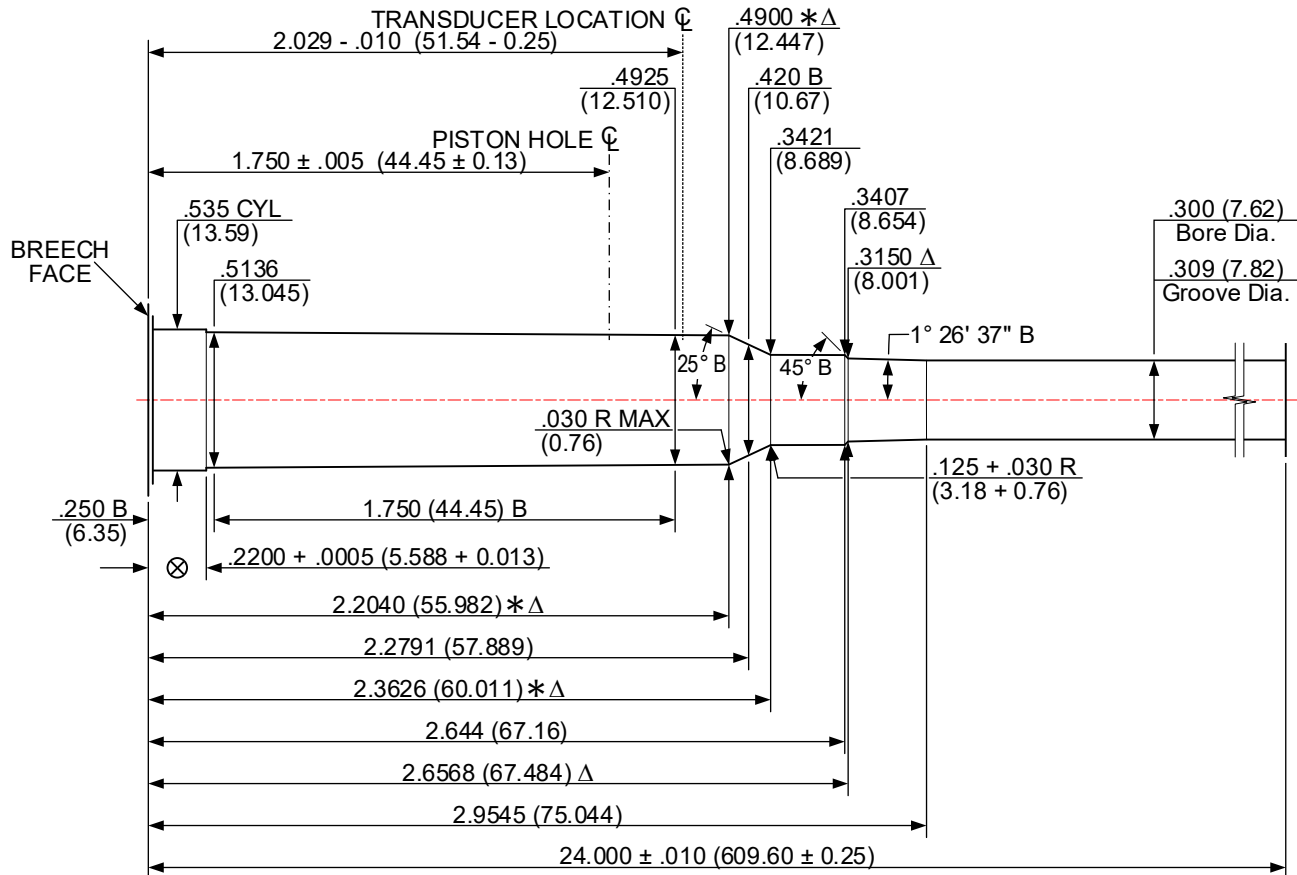

NUMBER OF GROOVES: 6
 WIDTH OF GROOVES: .110 + .002 (2.79 + 0.05)
 TWIST RATE: 10.00 (254.0) R.H.
 DIAMETER OF PISTON HOLE: .206 (5.23)
 TRANSDUCER DIAMETER: .250 (6.35)

LAND AND GROOVE DIMENSIONS TO BE
 WITHIN TOLERANCES THROUGHOUT
 LENGTH OF BARREL.

UNLESS OTHERWISE NOTED,
 ALL DIAMETERS +.0005 (0.013)
 LENGTH TOLERANCE + .005 (0.13)

DO NOT SCALE FROM DRAWING

NOTES:

B = BASIC

Δ = REFERENCE DIMENSION

\otimes = HEADSPACE DIMENSION

* DIMENSIONS ARE TO INTERSECTIONS OF LINES

(XX.XX) = MILLIMETERS

ALL CALCULATIONS APPLY AT MAXIMUM MATERIAL CONDITION (MMC)

300 WINCHESTER SHORT MAGNUM [300 WSM]
 ISSUED: 06/13/2001 V&P TEST BARREL REVISED: 07/11/2023

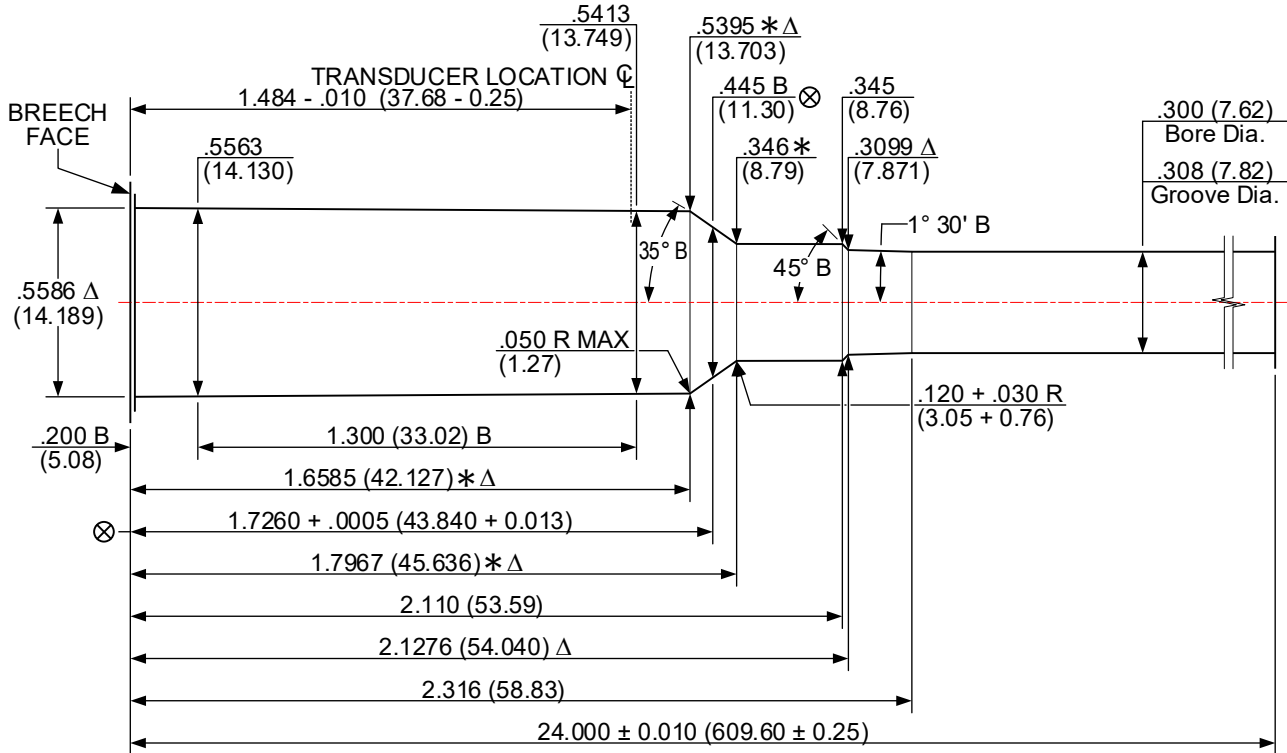

NUMBER OF GROOVES: 4
 WIDTH OF GROOVES: .1767 + .0020 (4.488 + 0.051)
 TWIST RATE: 10.00 (254.0) R.H.
 DIAMETER OF PISTON HOLE: Crusher pressures not established
 TRANSDUCER DIAMETER: .250 (6.35)

LAND AND GROOVE DIMENSIONS TO BE
 WITHIN TOLERANCES THROUGHOUT
 LENGTH OF BARREL.

UNLESS OTHERWISE NOTED,
 ALL DIAMETERS +.0005 (0.013)
 LENGTH TOLERANCE + .005 (0.13)

DO NOT SCALE FROM DRAWING

NOTES:

- B = BASIC
- Δ = REFERENCE DIMENSION
- ⊗ = HEADSPACE DIMENSION
- * DIMENSIONS ARE TO INTERSECTIONS OF LINES
- (XX.XX) = MILLIMETERS
- ALL CALCULATIONS APPLY AT MAXIMUM MATERIAL CONDITION (MMC)

303 BRITISH [303 BRIT]
V&P TEST BARREL
 ISSUED: 05/20/1980 REVISED: 07/11/2023

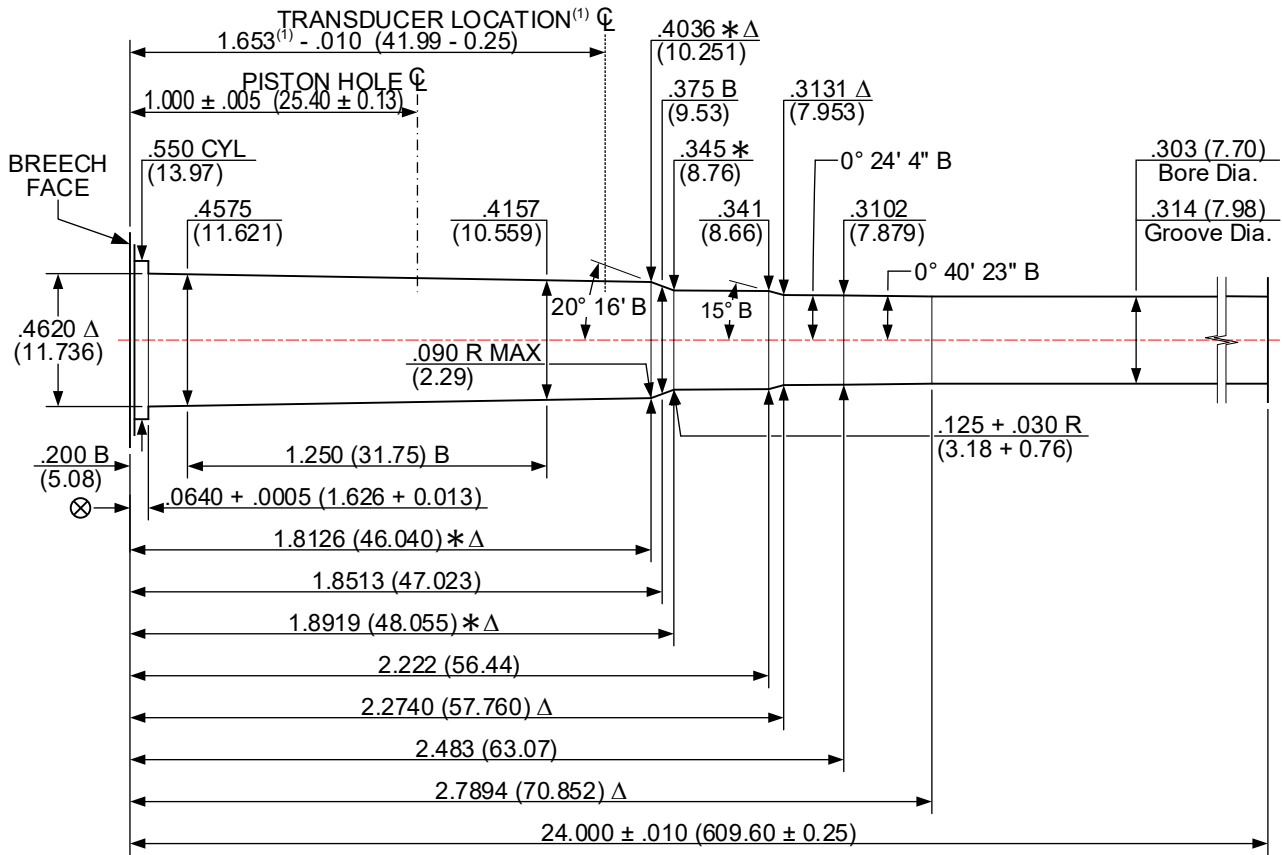

NUMBER OF GROOVES: 5
 WIDTH OF GROOVES: .0936 + .0020 (2.377 + 0.051)
 TWIST RATE: 10.00 (254.0) L.H.
 DIAMETER OF PISTON HOLE: .206 (5.23)
 TRANSDUCER DIAMETER: .250 (6.53)

LAND AND GROOVE DIMENSIONS TO BE
 WITHIN TOLERANCES THROUGHOUT
 LENGTH OF BARREL.

UNLESS OTHERWISE NOTED,
 ALL DIAMETERS +.0005 (0.013)
 LENGTH TOLERANCE + .005 (0.13)

DO NOT SCALE FROM DRAWING

NOTES:

- (1) - This transducer location is recognized as being inconsistent with the established criteria for transducer centerline.
- B = BASIC Δ = REFERENCE DIMENSION ⊗ = HEADSPACE DIMENSION
- * DIMENSIONS ARE TO INTERSECTIONS OF LINES (XX.XX) = MILLIMETERS
- ALL CALCULATIONS APPLY AT MAXIMUM MATERIAL CONDITION (MMC)

307 WINCHESTER [307 WIN]
V&P TEST BARREL REVISED: 07/11/2023

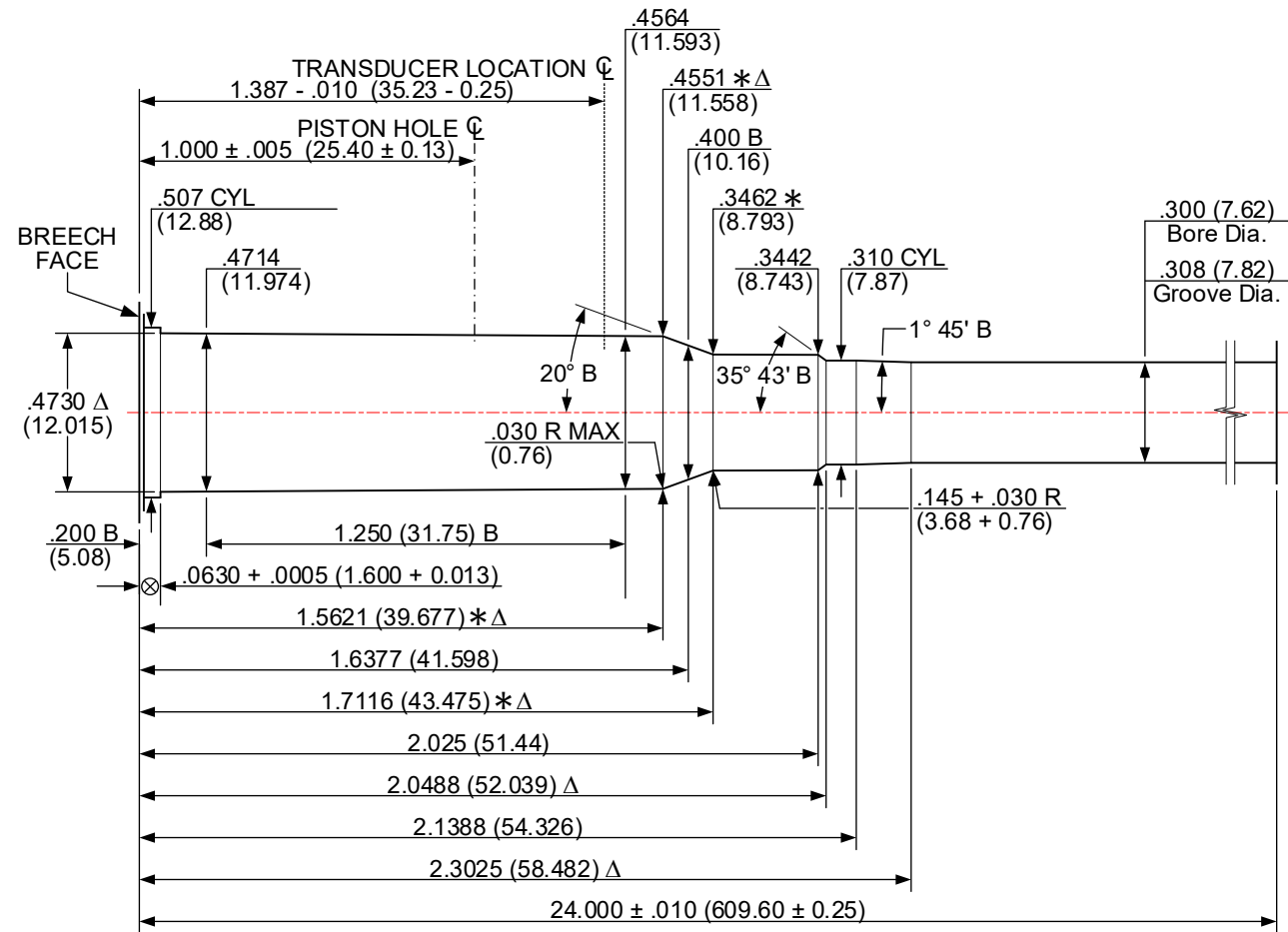

NUMBER OF GROOVES: 4
 WIDTH OF GROOVES: .176 + .002 (4.47 + 0.05)
 TWIST RATE: 12.00 (304.8) R.H.
 DIAMETER OF PISTON HOLE: .206 (5.23)
 TRANSDUCER DIAMETER: .250 (6.53)

LAND AND GROOVE DIMENSIONS TO BE
 WITHIN TOLERANCES THROUGHOUT
 LENGTH OF BARREL.

UNLESS OTHERWISE NOTED,
 ALL DIAMETERS +.0005 (0.013)
 LENGTH TOLERANCE + .005 (0.13)

DO NOT SCALE FROM DRAWING

NOTES:

B = BASIC

Δ = REFERENCE DIMENSION

⊗ = HEADSPACE DIMENSION

* DIMENSIONS ARE TO INTERSECTIONS OF LINES

(XX.XX) = MILLIMETERS

ALL CALCULATIONS APPLY AT MAXIMUM MATERIAL CONDITION (MMC)

308 MARLIN EXPRESS [308 MAR EXP]
 ISSUED: 01/05/2007 V&P TEST BARREL REVISED: 07/12/2023

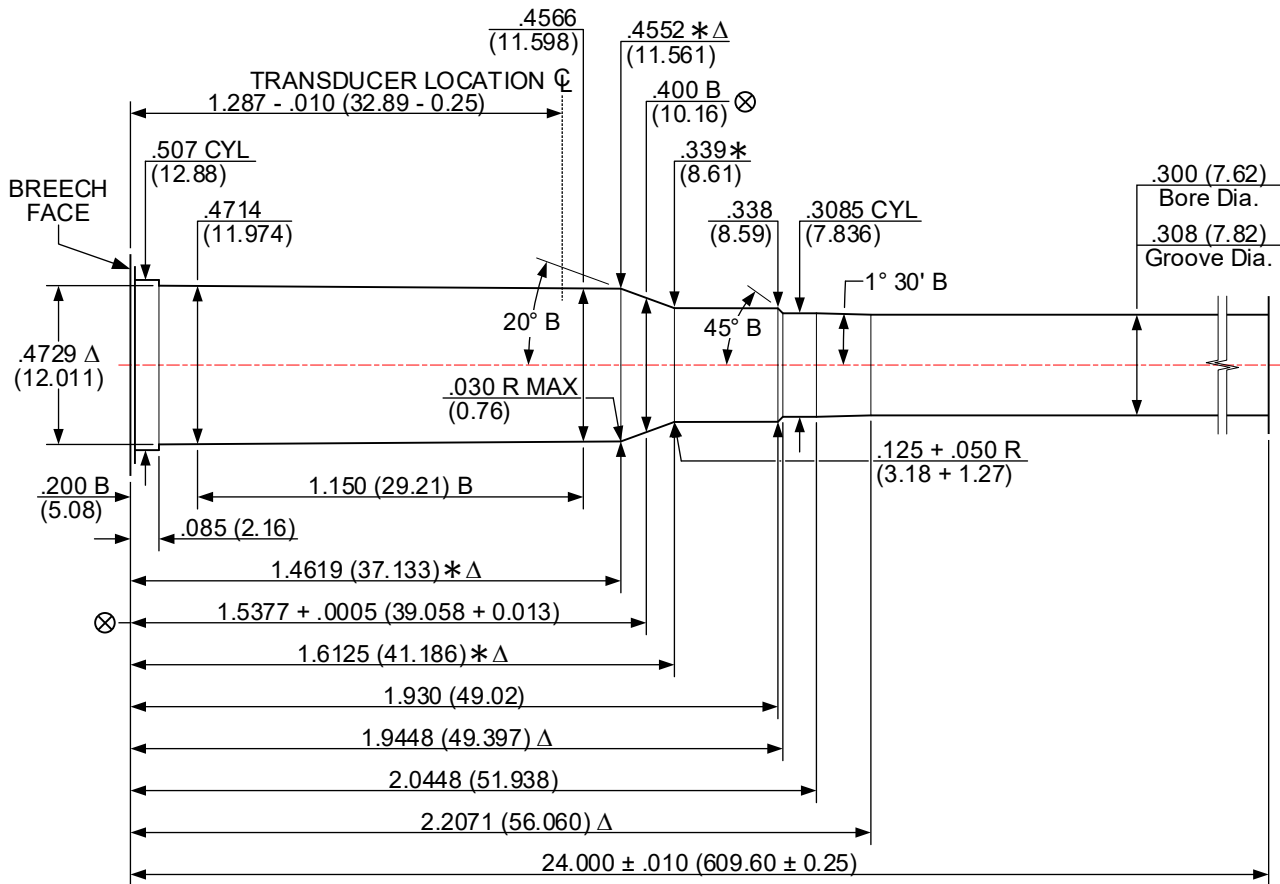

NUMBER OF GROOVES: 6
 WIDTH OF GROOVES: .0942 + .0020 (2.393 + 0.051)
 TWIST RATE: 12.00 (304.8) R.H.
 DIAMETER OF PISTON HOLE: Crusher pressures not established
 TRANSDUCER DIAMETER: .250 (6.53)

LAND AND GROOVE DIMENSIONS TO BE
 WITHIN TOLERANCES THROUGHOUT
 LENGTH OF BARREL.

UNLESS OTHERWISE NOTED,
 ALL DIAMETERS +.0005 (0.013)
 LENGTH TOLERANCE + .005 (0.13)

DO NOT SCALE FROM DRAWING

NOTES:

B = BASIC

Δ = REFERENCE DIMENSION

⊗ = HEADSPACE DIMENSION

* DIMENSIONS ARE TO INTERSECTIONS OF LINES

(XX.XX) = MILLIMETERS

ALL CALCULATIONS APPLY AT MAXIMUM MATERIAL CONDITION (MMC)

308 WINCHESTER [308 WIN]
 ISSUED: 05/20/1980 V&P TEST BARREL REVISED: 07/12/2023

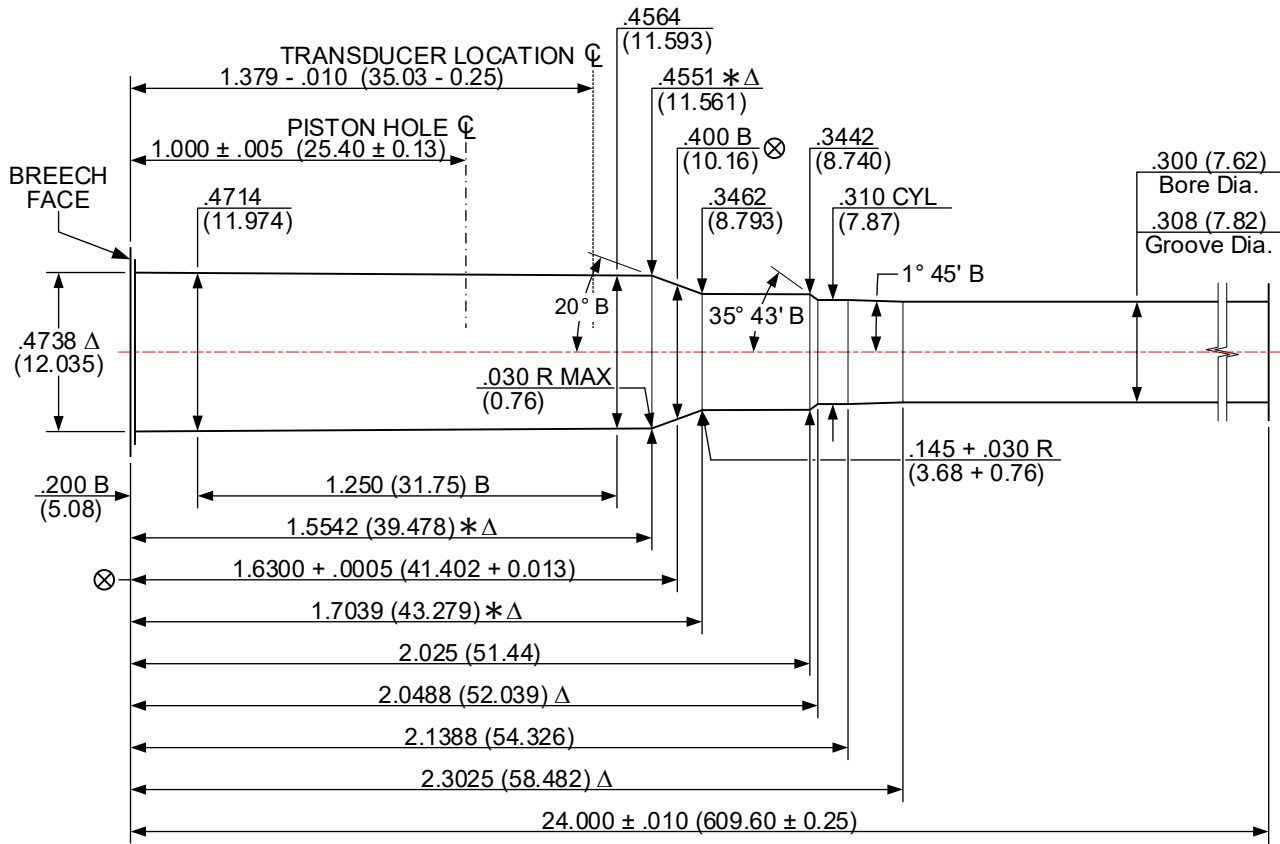

NUMBER OF GROOVES: 4
 WIDTH OF GROOVES: $.176 + .002$ (4.47 + 0.05)
 TWIST RATE: 12.00 (304.8) R.H.
 DIAMETER OF PISTON HOLE: $.206$ (5.23)
 TRANSDUCER DIAMETER: $.250$ (6.53)

LAND AND GROOVE DIMENSIONS TO BE
 WITHIN TOLERANCES THROUGHOUT
 LENGTH OF BARREL.

UNLESS OTHERWISE NOTED,
 ALL DIAMETERS $+ .0005$ (0.013)
 LENGTH TOLERANCE $+ .005$ (0.13)

DO NOT SCALE FROM DRAWING

NOTES:

B = BASIC

Δ = REFERENCE DIMENSION

\otimes = HEADSPACE DIMENSION

* DIMENSIONS ARE TO INTERSECTIONS OF LINES

(XX.XX) = MILLIMETERS

ALL CALCULATIONS APPLY AT MAXIMUM MATERIAL CONDITION (MMC)

32 WINCHESTER SPECIAL [32 WIN SPL]
ISSUED: 05/20/1980 **V&P TEST BARREL** **REVISED: 07/17/2023**

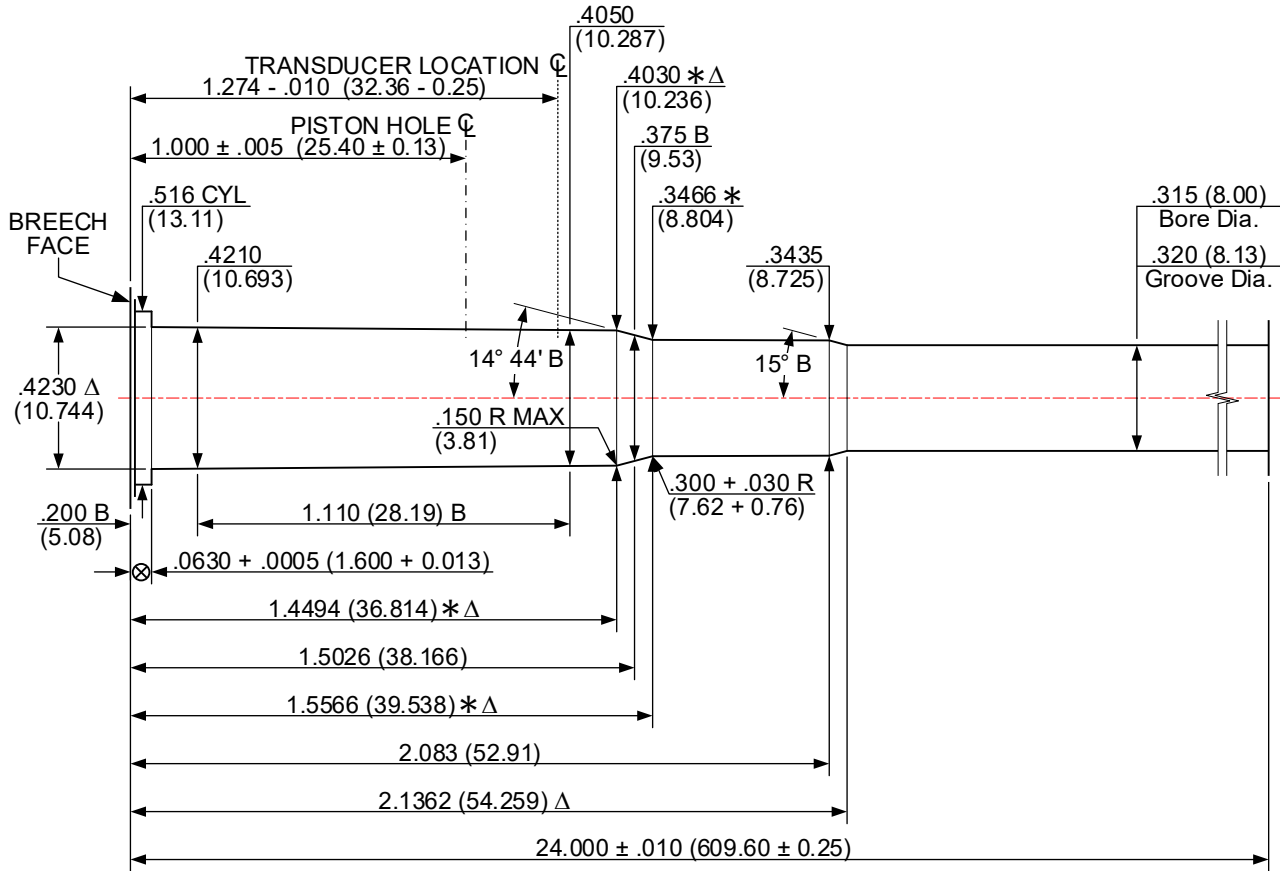

NUMBER OF GROOVES: 6
 WIDTH OF GROOVES: .106 + .002 (2.69 + 0.05)
 TWIST RATE: 16.00 (406.4) R.H.
 DIAMETER OF PISTON HOLE: .206 (5.23)
 TRANSDUCER DIAMETER: .250 (6.53)

LAND AND GROOVE DIMENSIONS TO BE
 WITHIN TOLERANCES THROUGHOUT
 LENGTH OF BARREL.

UNLESS OTHERWISE NOTED,
 ALL DIAMETERS +.0005 (0.013)
 LENGTH TOLERANCE + .005 (0.13)

DO NOT SCALE FROM DRAWING

NOTES:
 B = BASIC Δ = REFERENCE DIMENSION ⊗ = HEADSPACE DIMENSION
 * DIMENSIONS ARE TO INTERSECTIONS OF LINES (XX.XX) = MILLIMETERS
 ALL CALCULATIONS APPLY AT MAXIMUM MATERIAL CONDITION (MMC)

325 WINCHESTER SHORT MAGNUM [325 WSM]
 ISSUED: 06/27/2005 V&P TEST BARREL REVISED: 07/17/2023

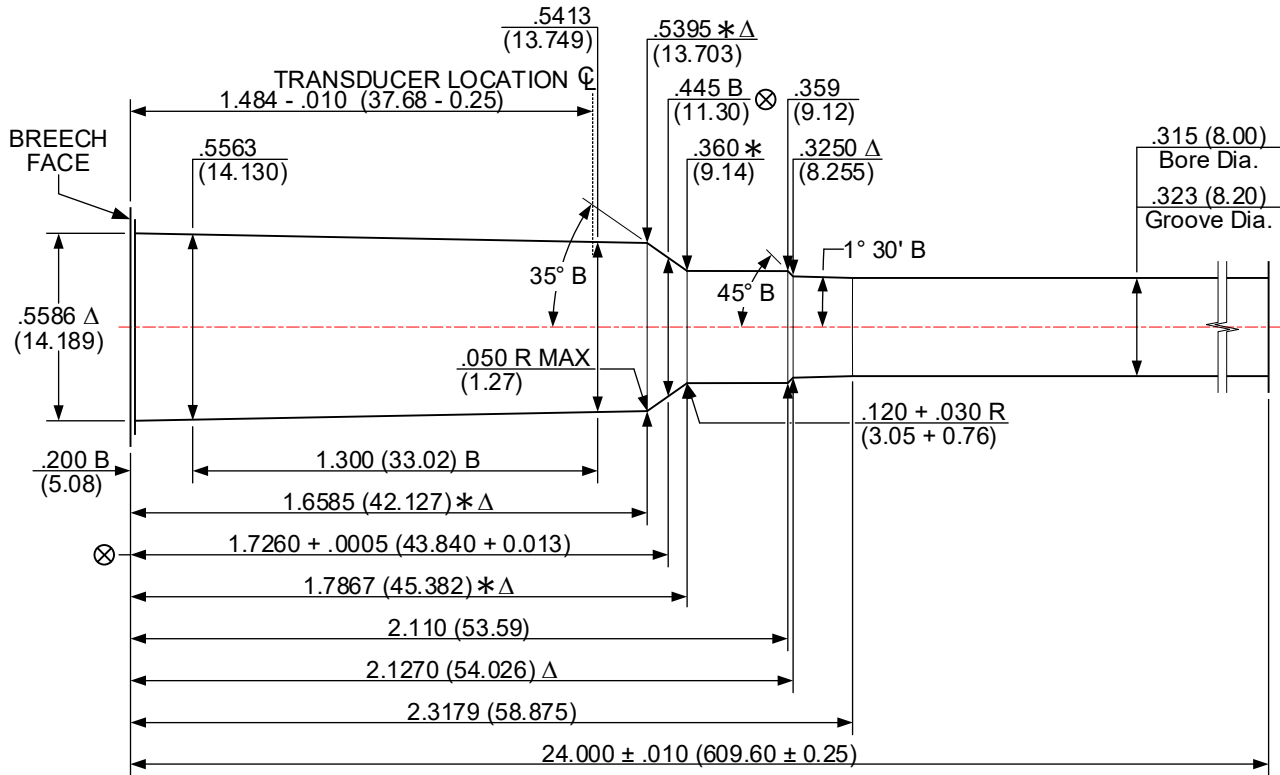

NUMBER OF GROOVES: 4
 WIDTH OF GROOVES: .1760 + .0020 (4.470 + 0.051)
 TWIST RATE: 10.00 (254.0) R.H.
 DIAMETER OF PISTON HOLE: Crusher pressures not established
 TRANSDUCER DIAMETER: .250 (6.35)

LAND AND GROOVE DIMENSIONS TO BE
 WITHIN TOLERANCES THROUGHOUT
 LENGTH OF BARREL.

UNLESS OTHERWISE NOTED,
 ALL DIAMETERS +.0005 (0.013)
 LENGTH TOLERANCE + .005 (0.13)

DO NOT SCALE FROM DRAWING

NOTES:

B = BASIC

Δ = REFERENCE DIMENSION

⊗ = HEADSPACE DIMENSION

* DIMENSIONS ARE TO INTERSECTIONS OF LINES

(XX.XX) = MILLIMETERS

ALL CALCULATIONS APPLY AT MAXIMUM MATERIAL CONDITION (MMC)

33 NOSLER [33 NOSLER]
 ISSUED: 01/19/2015 V&P TEST BARREL REVISED: 02/03/2022

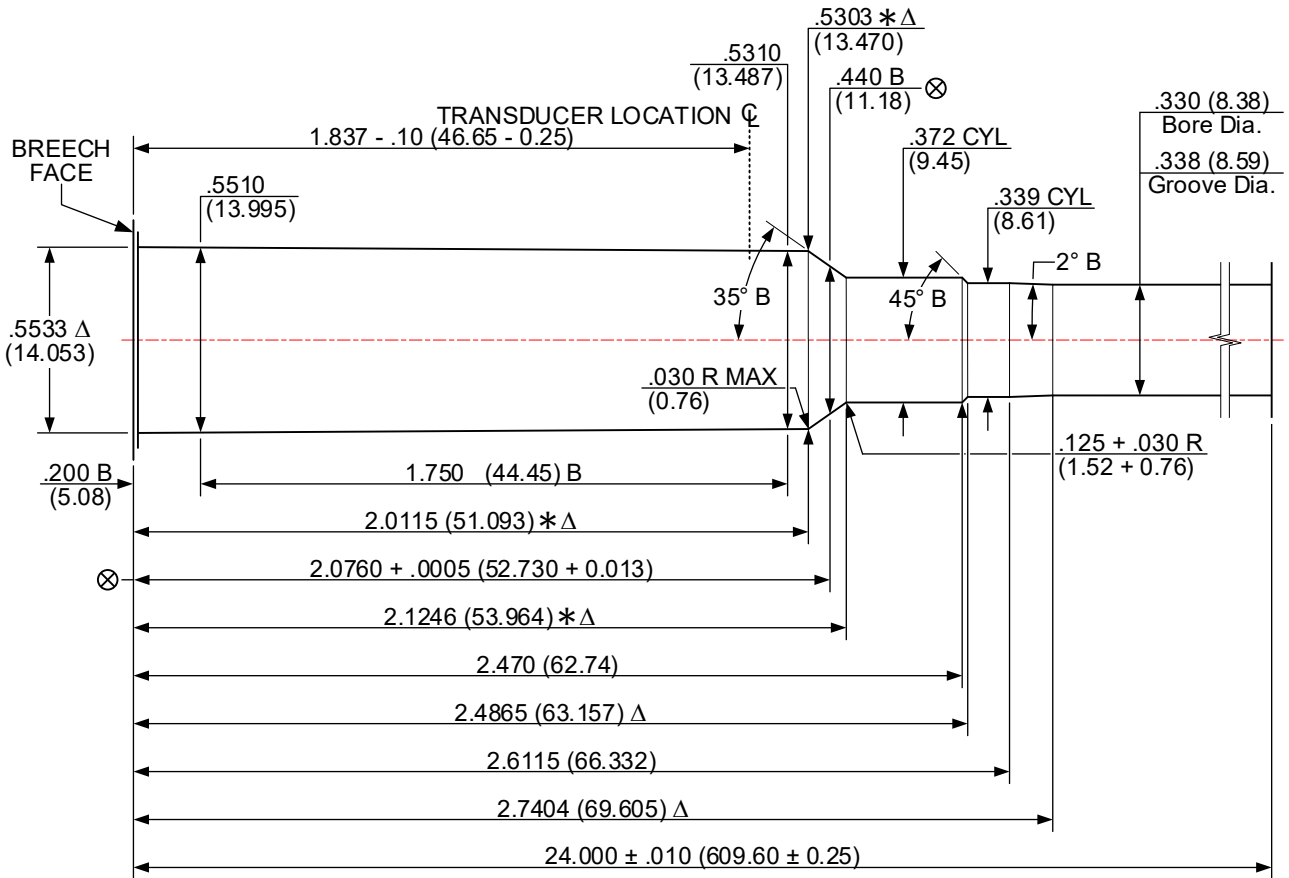

NUMBER OF GROOVES: 6
 WIDTH OF GROOVES: .110 + .002 (2.79 + 0.05)
 TWIST RATE: 10.00 (254.0) R.H.
 DIAMETER OF PISTON HOLE: Crusher pressures not established.
 TRANSDUCER DIAMETER: .250 (6.35)

LAND AND GROOVE DIMENSIONS TO BE
 WITHIN TOLERANCES THROUGHOUT
 LENGTH OF BARREL.

UNLESS OTHERWISE NOTED,
 ALL DIAMETERS +.0005 (0.013)
 LENGTH TOLERANCE + .005 (0.13)

DO NOT SCALE FROM DRAWING

NOTES:

B = BASIC

Δ = REFERENCE DIMENSION

⊗ = HEADSPACE DIMENSION

* DIMENSIONS ARE TO INTERSECTIONS OF LINES

(XX.XX) = MILLIMETERS

ALL CALCULATIONS APPLY AT MAXIMUM MATERIAL CONDITION (MMC)

338 FEDERAL [338 FED]
 ISSUED: 06/28/2006 V&P TEST BARREL REVISED: 07/19/2023

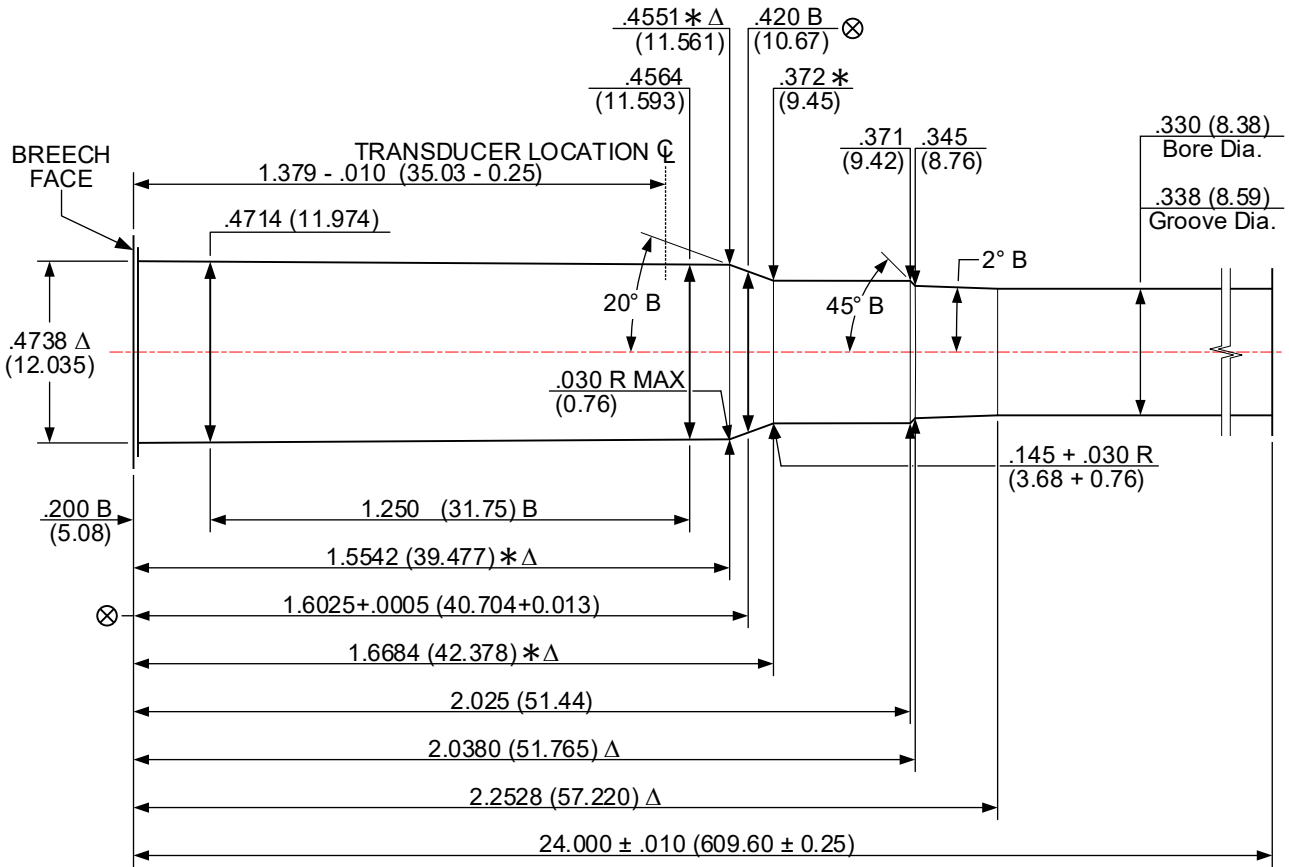

NUMBER OF GROOVES: 6
 WIDTH OF GROOVES: .110 + .002 (2.79 + 0.05)
 TWIST RATE: 10.00 (254.0) R.H.
 DIAMETER OF PISTON HOLE: Crusher pressures not established.
 TRANSDUCER DIAMETER: .250 (6.53)

LAND AND GROOVE DIMENSIONS TO BE
 WITHIN TOLERANCES THROUGHOUT
 LENGTH OF BARREL.

UNLESS OTHERWISE NOTED,
 ALL DIAMETERS +.0005 (0.013)
 LENGTH TOLERANCE + .005 (0.13)

DO NOT SCALE FROM DRAWING

NOTES:

- B = BASIC
- * DIMENSIONS ARE TO INTERSECTIONS OF LINES
- ALL CALCULATIONS APPLY AT MAXIMUM MATERIAL CONDITION (MMC)
- Δ = REFERENCE DIMENSION
- ⊗ = HEADSPACE DIMENSION
- (XX.XX) = MILLIMETERS

338 LAPUA MAGNUM [338 LAPUA MAG]
 ISSUED: 06/12/2007 V&P TEST BARREL REVISED: 07/21/2023

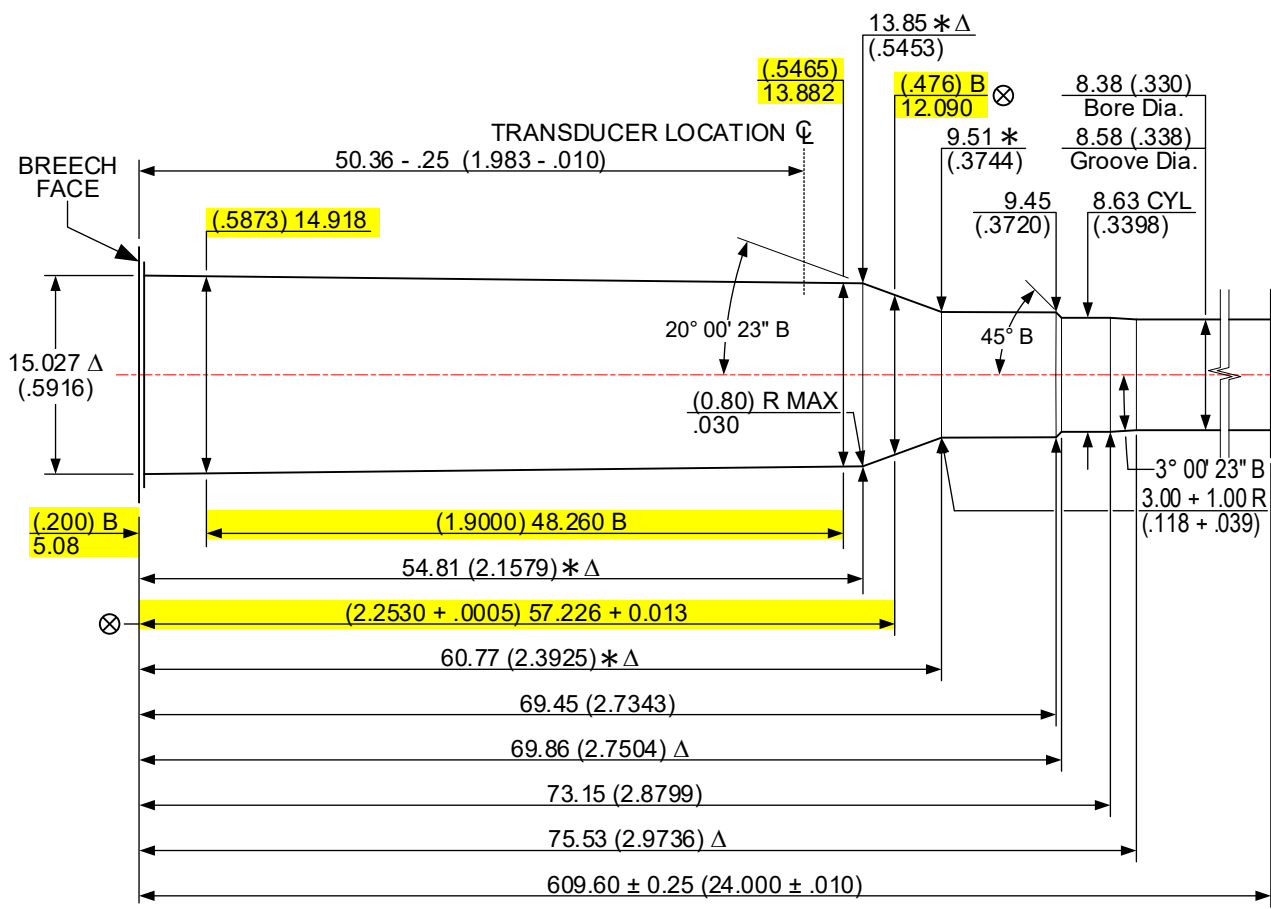

HIGHLIGHTED DIMENSIONS HAVE NO CORRESPONDING C.I.P. ANALOG. THE ENGLISH UNITS FOR THESE ARE THE ORIGINAL VALUES; METRIC VALUES ARE CALCULATED AND ROUNDED.

- NUMBER OF GROOVES: 6
- WIDTH OF GROOVES: 2.79 + .05 (.110 + 0.002)
- TWIST RATE: 254.0 (10.00) R.H.
- DIAMETER OF PISTON HOLE: Crusher pressure not established.
- TRANSDUCER DIAMETER: 6.35 (.250)

LAND AND GROOVE DIMENSIONS TO BE WITHIN TOLERANCES THROUGHOUT LENGTH OF BARREL.

UNLESS OTHERWISE NOTED, ALL DIAMETERS +.0005 (0.013) LENGTH TOLERANCE + .005 (0.13)

DO NOT SCALE FROM DRAWING

- NOTES:**
- B = BASIC
 - * DIMENSIONS ARE TO INTERSECTIONS OF LINES
 - ALL CALCULATIONS APPLY AT MAXIMUM MATERIAL CONDITION (MMC)
 - Δ = REFERENCE DIMENSION
 - ⊗ = HEADSPACE DIMENSION
 - (XX.XX) = MILLIMETERS

METRIC METRIC METRIC METRIC METRIC

NOTICE: This drawing is subject to change. Revisions, if applicable, are available at www.saami.org.

338 MARLIN EXPRESS [338 ME]
 ISSUED: 06/17/2009 V&P TEST BARREL REVISED: 07/21/2023

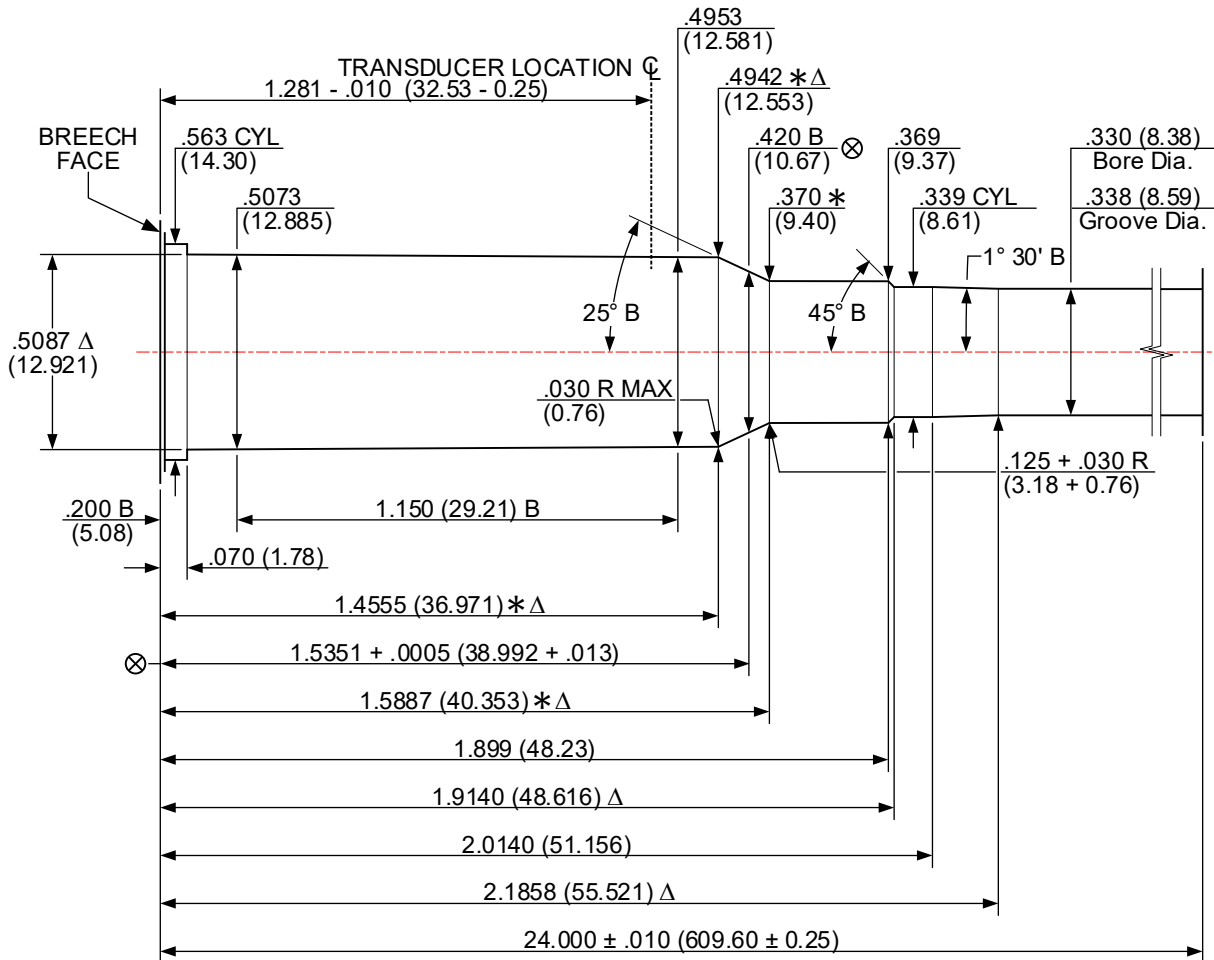

NUMBER OF GROOVES: 6
 WIDTH OF GROOVES: .110 + .002 (2.79 + 0.05)
 TWIST RATE: 12.00 (304.8) R.H.
 DIAMETER OF PISTON HOLE: Crusher pressures not established
 TRANSDUCER DIAMETER: .250 (6.53)

LAND AND GROOVE DIMENSIONS TO BE
 WITHIN TOLERANCES THROUGHOUT
 LENGTH OF BARREL.

UNLESS OTHERWISE NOTED,
 ALL DIAMETERS +.0005 (0.013)
 LENGTH TOLERANCE + .005 (0.13)

DO NOT SCALE FROM DRAWING

NOTES:

B = BASIC

Δ = REFERENCE DIMENSION

⊗ = HEADSPACE DIMENSION

* DIMENSIONS ARE TO INTERSECTIONS OF LINES

(XX.XX) = MILLIMETERS

ALL CALCULATIONS APPLY AT MAXIMUM MATERIAL CONDITION (MMC)

338 NORMA MAGNUM [338 NM]
 ISSUED: 09/24/2020 V&P TEST BARREL REVISED: 10/11/2024

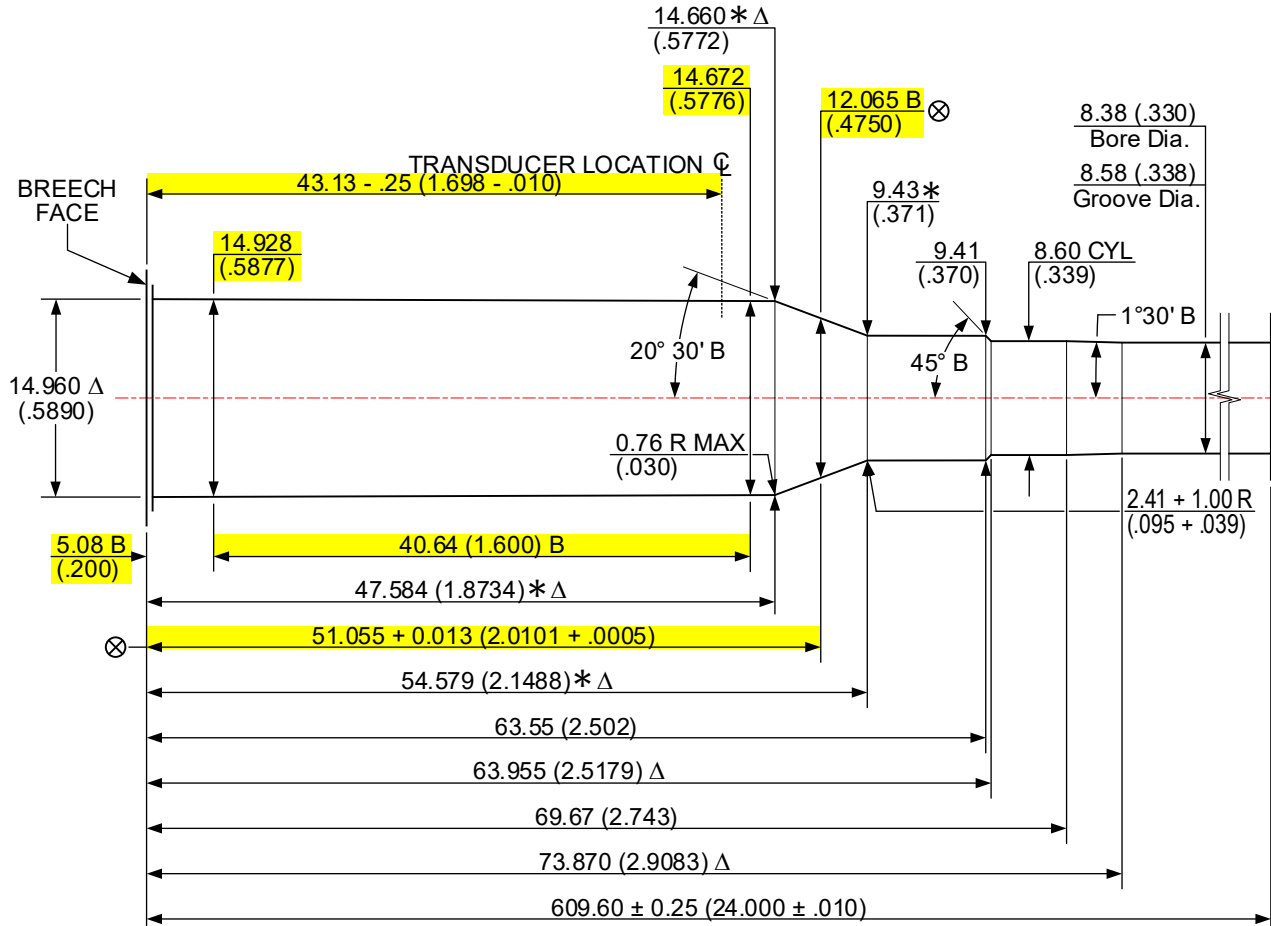

HIGHLIGHTED DIMENSIONS HAVE NO CORRESPONDING C.I.P. ANALOG. THE METRIC UNITS FOR THESE ARE THE ORIGINAL VALUES; U.S. CUSTOMARY VALUES ARE CALCULATED AND ROUNDED.

- NUMBER OF GROOVES: 6
- WIDTH OF GROOVES: 2.79 + .05 (.110 + 0.002)
- TWIST RATE: 235.0 (9.25) R.H.
- DIAMETER OF PISTON HOLE: Crusher pressure not established.
- TRANSDUCER DIAMETER: 6.35 (.250)

LAND AND GROOVE DIMENSIONS TO BE WITHIN TOLERANCES THROUGHOUT LENGTH OF BARREL.

UNLESS OTHERWISE NOTED, ALL DIAMETERS +.0005 (0.013) LENGTH TOLERANCE + .005 (0.13)

DO NOT SCALE FROM DRAWING

NOTES:

- B = BASIC
- * DIMENSIONS ARE TO INTERSECTIONS OF LINES
- ALL CALCULATIONS APPLY AT MAXIMUM MATERIAL CONDITION (MMC)
- Δ = REFERENCE DIMENSION
- ⊗ = HEADSPACE DIMENSION
- (XX.XX) = MILLIMETERS

NOTICE: This drawing is subject to change. Revisions, if applicable, are available at www.saami.org.

338 REMINGTON ULTRA MAGNUM [338 REM ULTRA MAG]
 ISSUED: 10/08/1999 V&P TEST BARREL REVISED: 02/04/2022

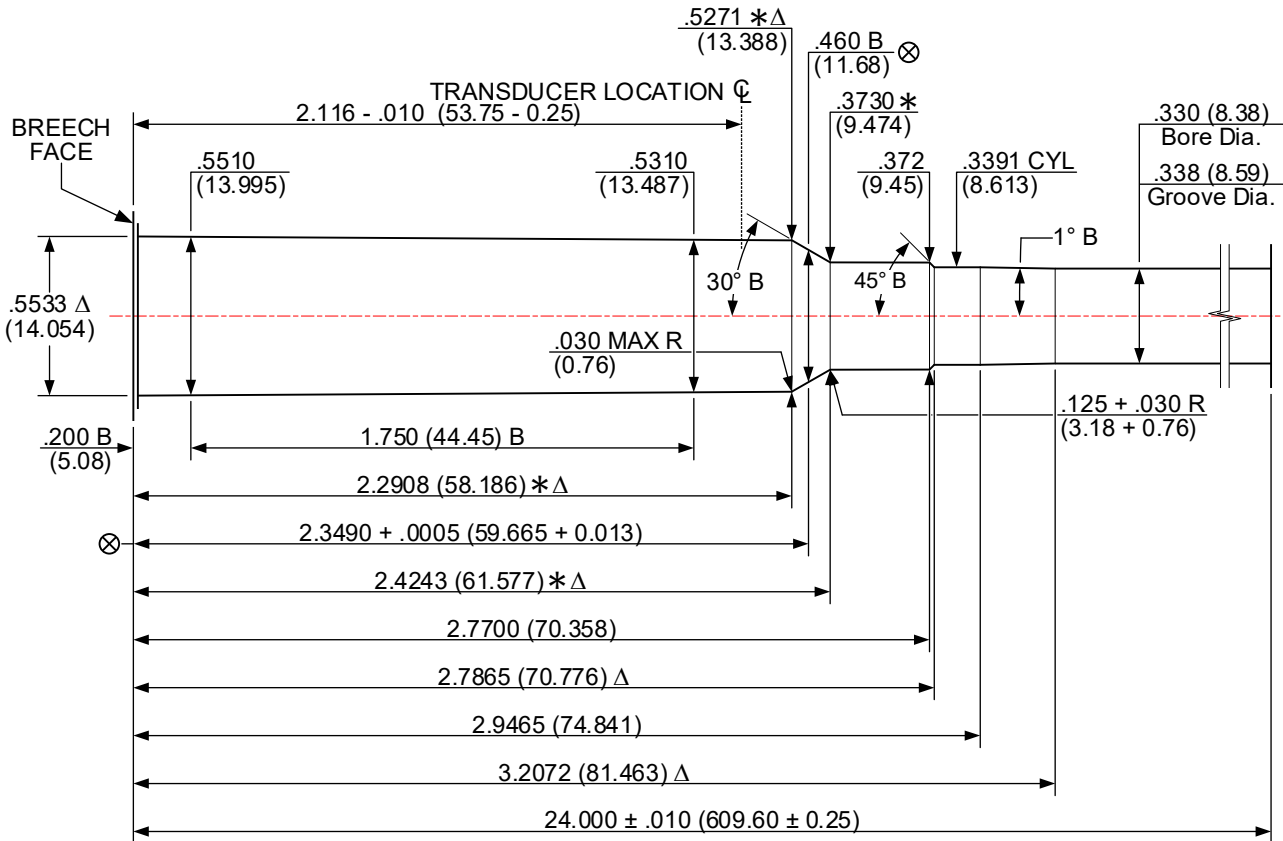

NUMBER OF GROOVES: 6
 WIDTH OF GROOVES: .110 + .002 (2.79 + 0.05)
 TWIST RATE: 10.00 (254.0) R.H.
 DIAMETER OF PISTON HOLE: Crusher pressure not established.
 TRANSDUCER DIAMETER: .250 (6.35)

LAND AND GROOVE DIMENSIONS TO BE
 WITHIN TOLERANCES THROUGHOUT
 LENGTH OF BARREL.

UNLESS OTHERWISE NOTED,
 ALL DIAMETERS +.0005 (0.013)
 LENGTH TOLERANCE + .005 (0.13)

DO NOT SCALE FROM DRAWING

NOTES:

B = BASIC

Δ = REFERENCE DIMENSION

⊗ = HEADSPACE DIMENSION

* DIMENSIONS ARE TO INTERSECTIONS OF LINES

(XX.XX) = MILLIMETERS

ALL CALCULATIONS APPLY AT MAXIMUM MATERIAL CONDITION (MMC)

338 RUGER COMPACT MAGNUM [338 RCM]
 ISSUED: 01/30/2008 V&P TEST BARREL REVISED: 07/21/2023

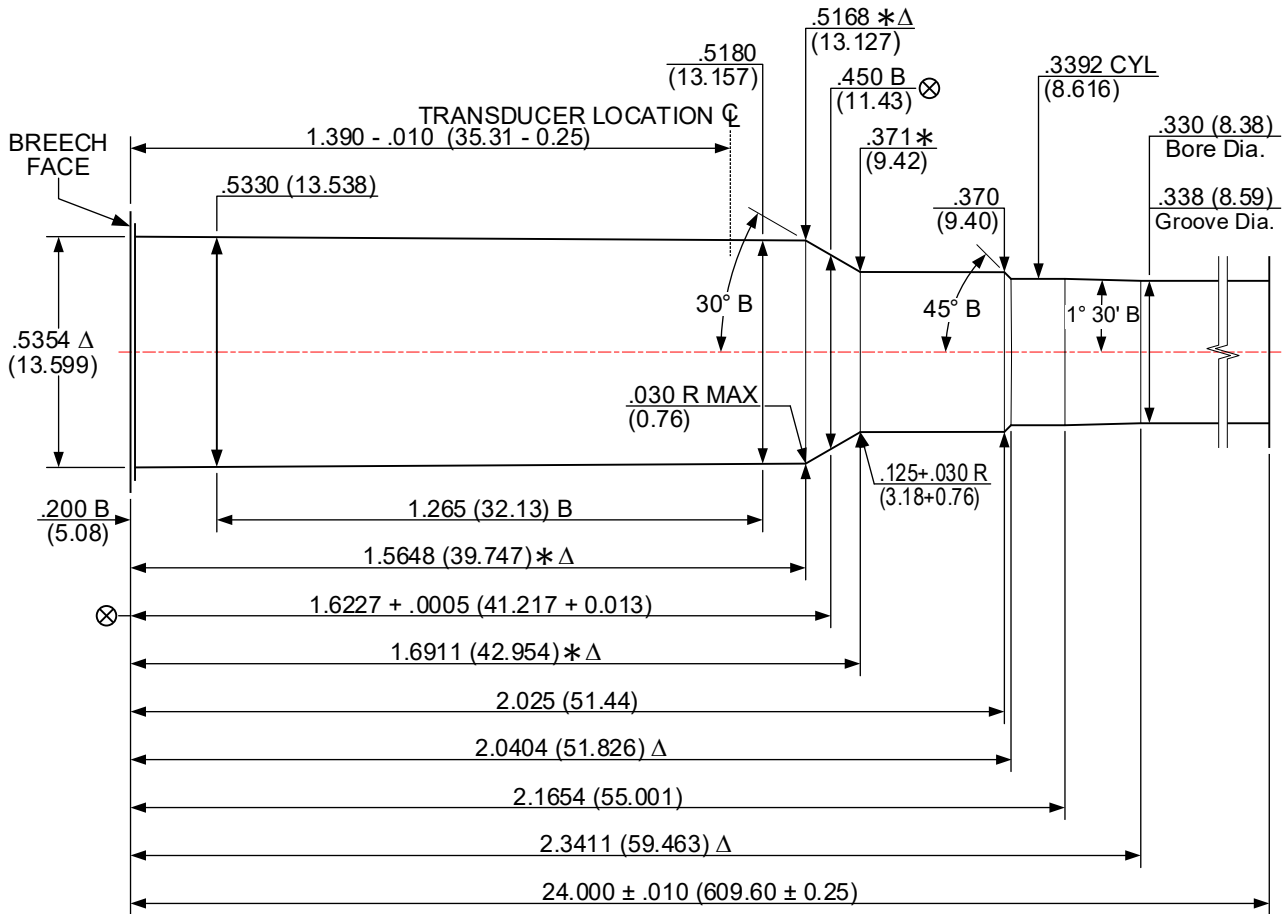

NUMBER OF GROOVES: 6
 WIDTH OF GROOVES: .110 + .002 (2.79 + 0.051)
 TWIST RATE: 10.00 (254.0) R.H.
 DIAMETER OF PISTON HOLE: Crusher pressures not established
 TRANSUDER DIAMETER: .250 (6.35)

LAND AND GROOVE DIMENSIONS TO BE
 WITHIN TOLERANCES THROUGHOUT
 LENGTH OF BARREL.

UNLESS OTHERWISE NOTED,
 ALL DIAMETERS +.0005 (0.013)
 LENGTH TOLERANCE + .005 (0.13)

DO NOT SCALE FROM DRAWING

NOTES:

B = BASIC

Δ = REFERENCE DIMENSION

⊗ = HEADSPACE DIMENSION

* DIMENSIONS ARE TO INTERSECTIONS OF LINES

(XX.XX) = MILLIMETERS

ALL CALCULATIONS APPLY AT MAXIMUM MATERIAL CONDITION (MMC)

338 WEATHERBY REBATED PRECISION MAGNUM [338 WBYP RPM]
 ISSUED: 07/21/2023 V&P TEST BARREL REVISED: 02/04/2022

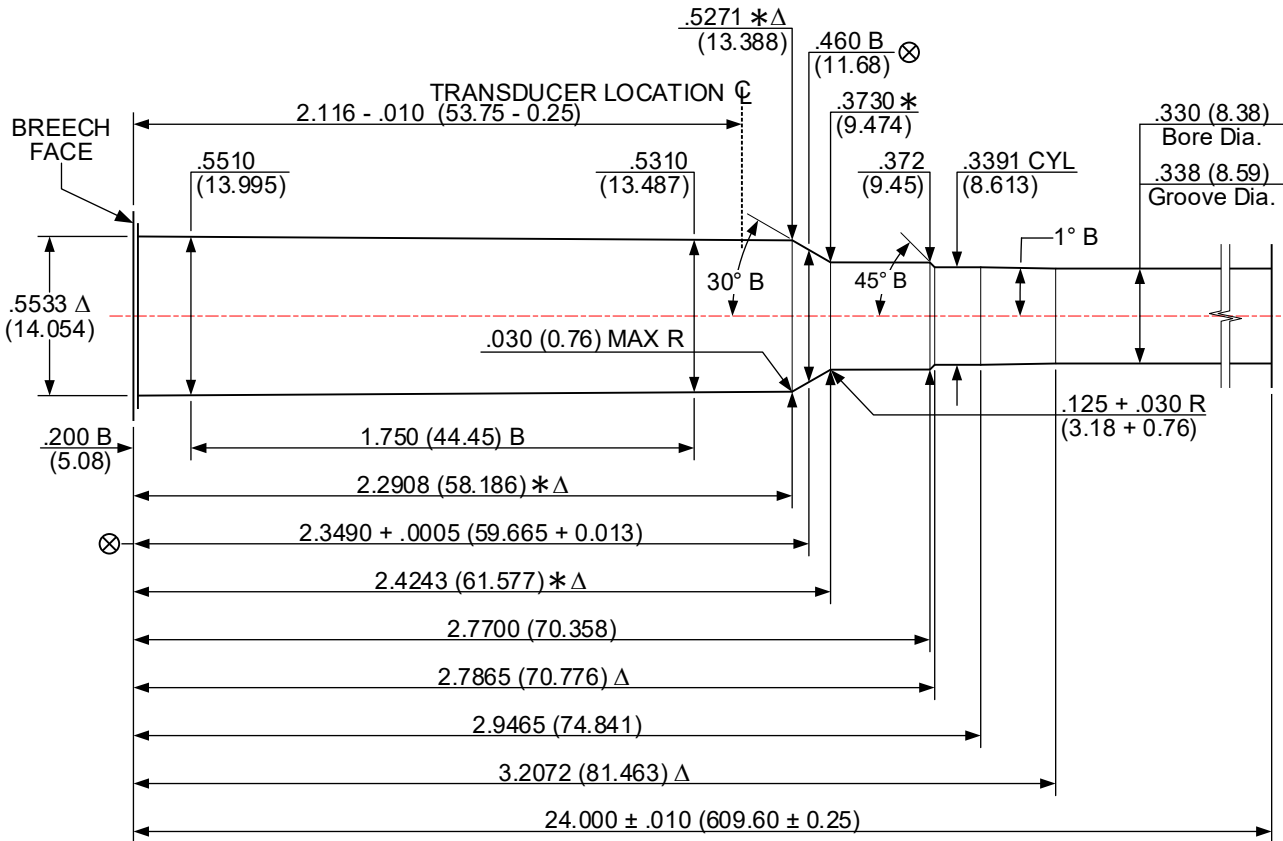

NUMBER OF GROOVES: 6
 WIDTH OF GROOVES: .110 + .002 (2.79 + 0.05)
 TWIST RATE: 10.00 (254.0) R.H.
 DIAMETER OF PISTON HOLE: Crusher pressure not established.
 TRANSDUCER DIAMETER: .250 (6.35)

LAND AND GROOVE DIMENSIONS TO BE
 WITHIN TOLERANCES THROUGHOUT
 LENGTH OF BARREL.

UNLESS OTHERWISE NOTED,
 ALL DIAMETERS +.0005 (0.013)
 LENGTH TOLERANCE + .005 (0.13)

DO NOT SCALE FROM DRAWING

NOTE:

B = BASIC

Δ = REFERENCE DIMENSION

⊗ = HEADSPACE DIMENSION

* DIMENSIONS ARE TO INTERSECTIONS OF LINES

(XX.XX) = MILLIMETERS

ALL CALCULATIONS APPLY AT MAXIMUM MATERIAL CONDITION (MMC)

338 WINCHESTER MAGNUM [338 WIN MAG]
 ISSUED: 05/20/1980 V&P TEST BARREL REVISED: 02/04/2022

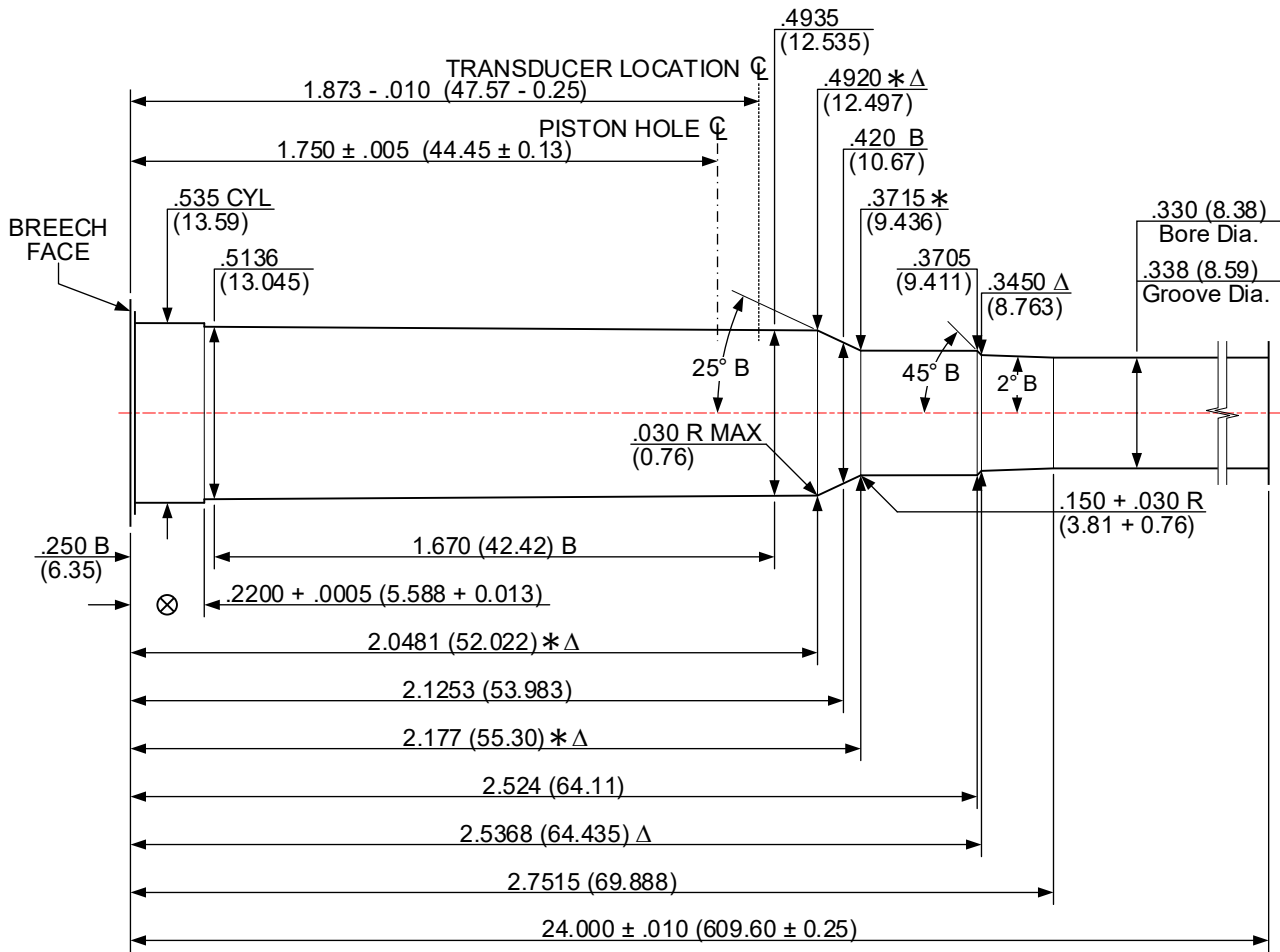

NUMBER OF GROOVES: 6
 WIDTH OF GROOVES: .110 + .002 (2.79 + 0.05)
 TWIST RATE: 10.00 (254.0) R.H.
 DIAMETER OF PISTON HOLE: .206 (5.23)
 TRANSDUCER DIAMETER: .250 (6.35)

LAND AND GROOVE DIMENSIONS TO BE
 WITHIN TOLERANCES THROUGHOUT
 LENGTH OF BARREL.

UNLESS OTHERWISE NOTED,
 ALL DIAMETERS +.0005 (0.013)
 LENGTH TOLERANCE + .005 (0.13)

DO NOT SCALE FROM DRAWING

NOTES:

B = BASIC

Δ = REFERENCE DIMENSION

⊗ = HEADSPACE DIMENSION

* DIMENSIONS ARE TO INTERSECTIONS OF LINES

(XX.XX) = MILLIMETERS

ALL CALCULATIONS APPLY AT MAXIMUM MATERIAL CONDITION (MMC)

340 WEATHERBY MAGNUM [340 WBY MAG]
 ISSUED: 01/12/1994 V&P TEST BARREL REVISED: 01/21/2024

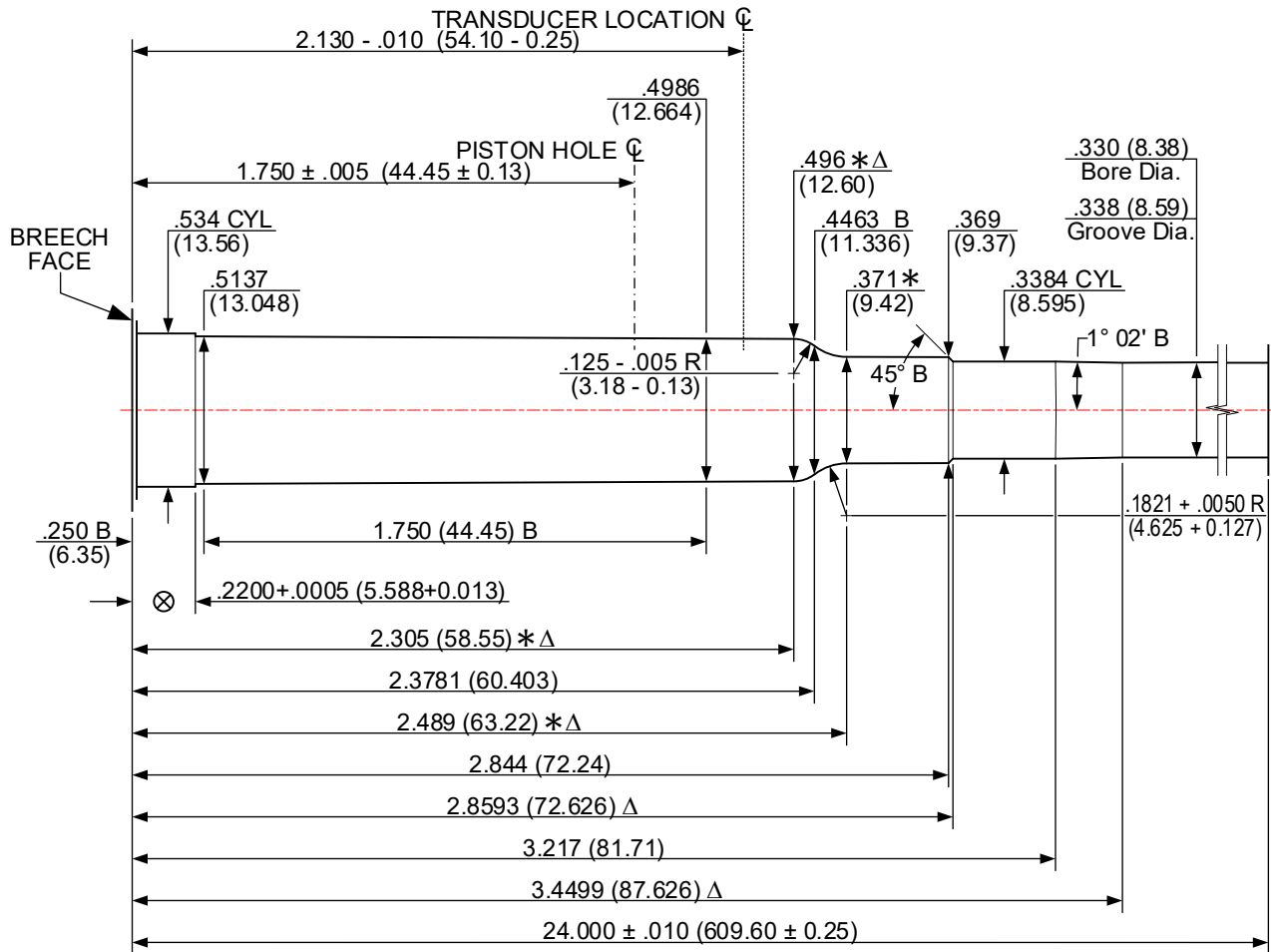

NUMBER OF GROOVES: 6
 WIDTH OF GROOVES: .126 + .002 (3.20 + 0.05)
 TWIST RATE: 10.00 (254.0) R.H.
 DIAMETER OF PISTON HOLE: .206 (5.23)
 TRANSDUCER DIAMETER: .250 (6.35)

LAND AND GROOVE DIMENSIONS TO BE
 WITHIN TOLERANCES THROUGHOUT
 LENGTH OF BARREL.

UNLESS OTHERWISE NOTED,
 ALL DIAMETERS +.0005 (0.013)
 LENGTH TOLERANCE + .005 (0.13)

DO NOT SCALE FROM DRAWING

NOTES:

B = BASIC

Δ = REFERENCE DIMENSION

⊗ = HEADSPACE DIMENSION

* DIMENSIONS ARE TO INTERSECTIONS OF LINES

(XX.XX) = MILLIMETERS

ALL CALCULATIONS APPLY AT MAXIMUM MATERIAL CONDITION (MMC)

348 WINCHESTER [348 WIN]
 ISSUED: 05/20/1980 V&P TEST BARREL REVISED: 10/07/2023

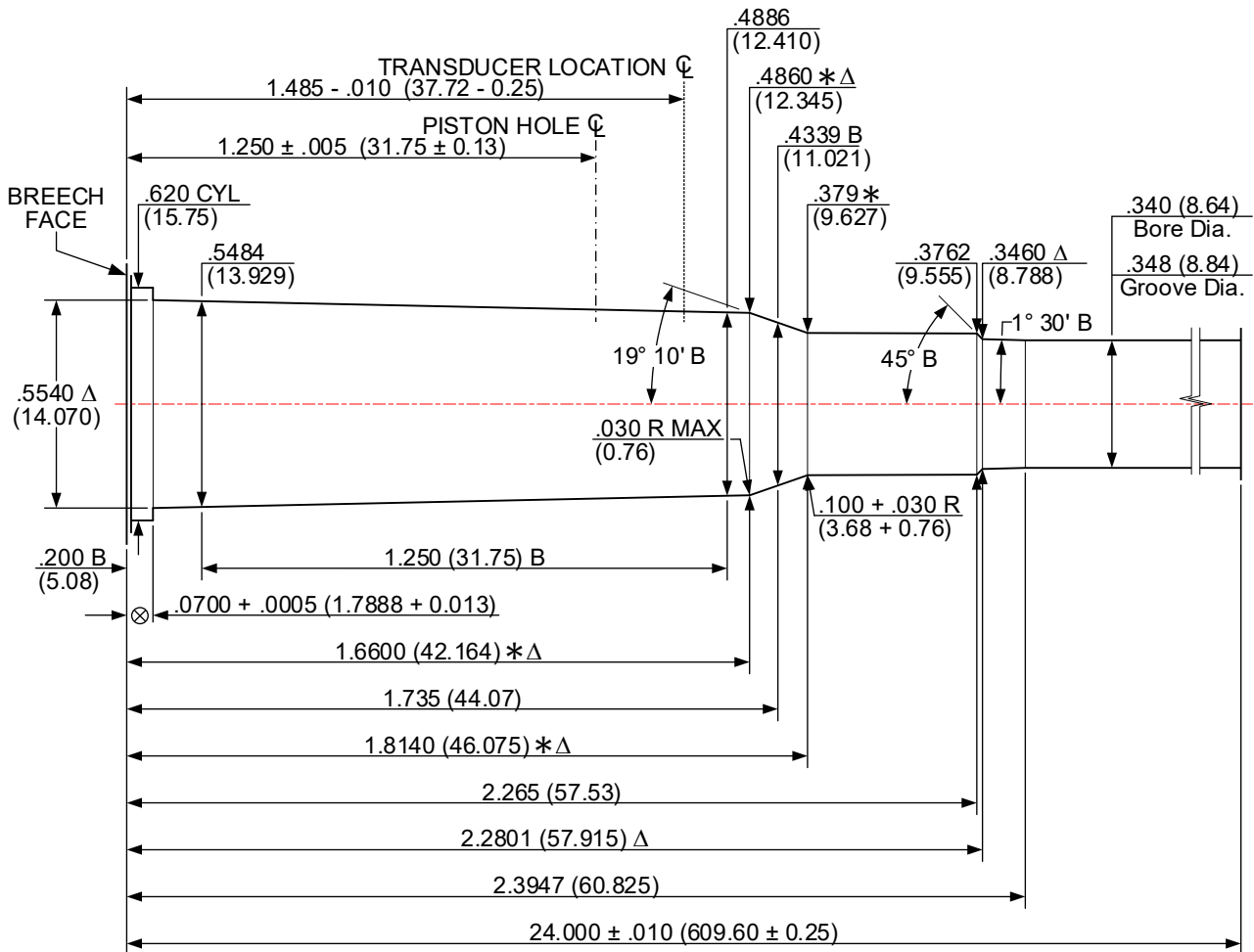

NUMBER OF GROOVES: 6
 WIDTH OF GROOVES: .120 + .002 (3.05 + 0.05)
 TWIST RATE: 12.00 (304.8) R.H.
 DIAMETER OF PISTON HOLE: .206 (5.23)
 TRANSDUCER DIAMETER: .250 (6.53)

LAND AND GROOVE DIMENSIONS TO BE
 WITHIN TOLERANCES THROUGHOUT
 LENGTH OF BARREL.

UNLESS OTHERWISE NOTED,
 ALL DIAMETERS +.0005 (0.013)
 LENGTH TOLERANCE + .005 (0.13)

DO NOT SCALE FROM DRAWING

NOTES:

B = BASIC

Δ = REFERENCE DIMENSION

⊗ = HEADSPACE DIMENSION

* DIMENSIONS ARE TO INTERSECTIONS OF LINES

(XX.XX) = MILLIMETERS

ALL CALCULATIONS APPLY AT MAXIMUM MATERIAL CONDITION (MMC)

35 REMINGTON [35 REM]
 ISSUED: 06/04/1998 V&P TEST BARREL REVISED: 07/24/2023

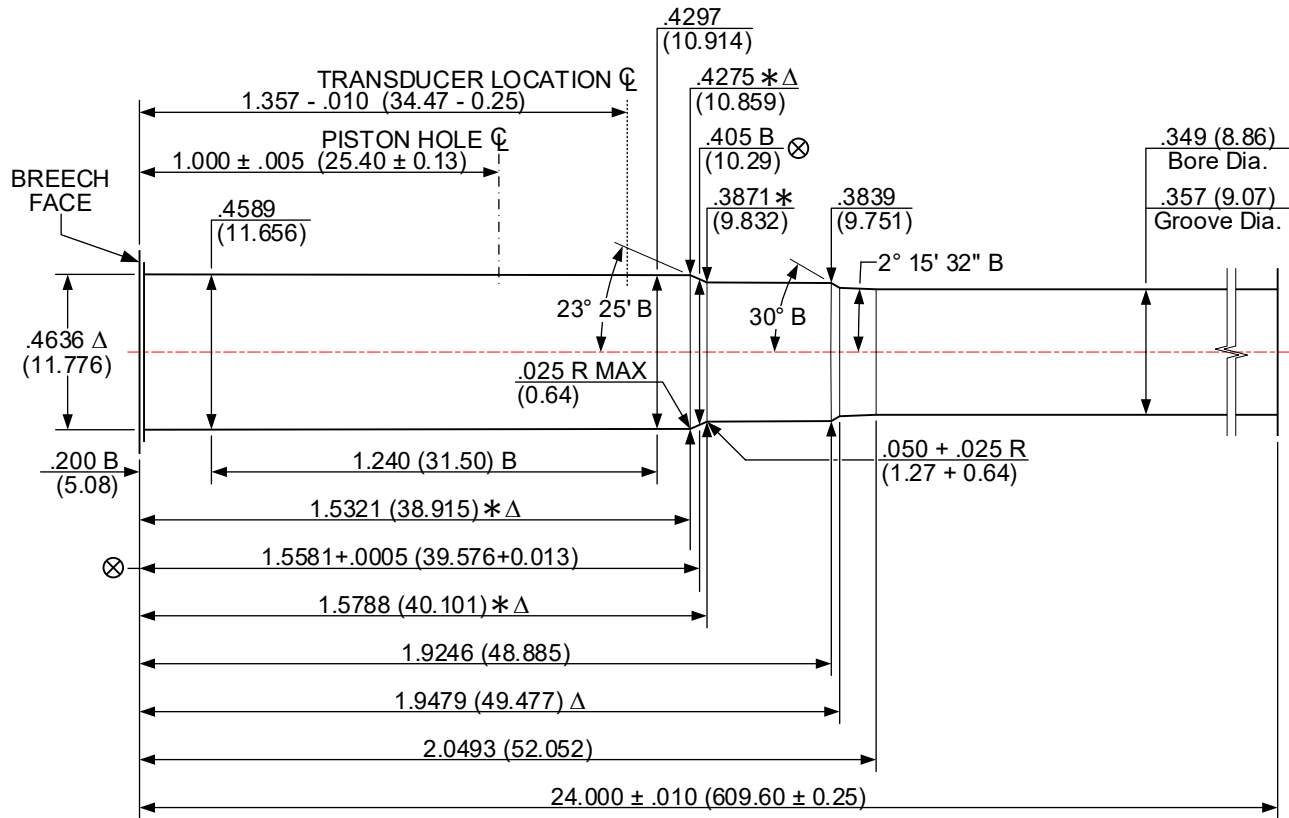

NUMBER OF GROOVES: 7
 WIDTH OF GROOVES: .115 + .002 (2.92 + 0.05)
 TWIST RATE: 16.00 (406.4) R.H.
 DIAMETER OF PISTON HOLE: .206 (5.23)
 TRANSDUCER DIAMETER: .250 (6.35)

LAND AND GROOVE DIMENSIONS TO BE
 WITHIN TOLERANCES THROUGHOUT
 LENGTH OF BARREL.

UNLESS OTHERWISE NOTED,
 ALL DIAMETERS +.0005 (0.013)
 LENGTH TOLERANCE + .005 (0.13)

DO NOT SCALE FROM DRAWING

NOTES:

B = BASIC

Δ = REFERENCE DIMENSION

⊗ = HEADSPACE DIMENSION

* DIMENSIONS ARE TO INTERSECTIONS OF LINES

(XX.XX) = MILLIMETERS

ALL CALCULATIONS APPLY AT MAXIMUM MATERIAL CONDITION (MMC)

35 WHELEN [35 WHELEN]
 ISSUED: 06/04/1998 V&P TEST BARREL REVISED: 07/24/2023

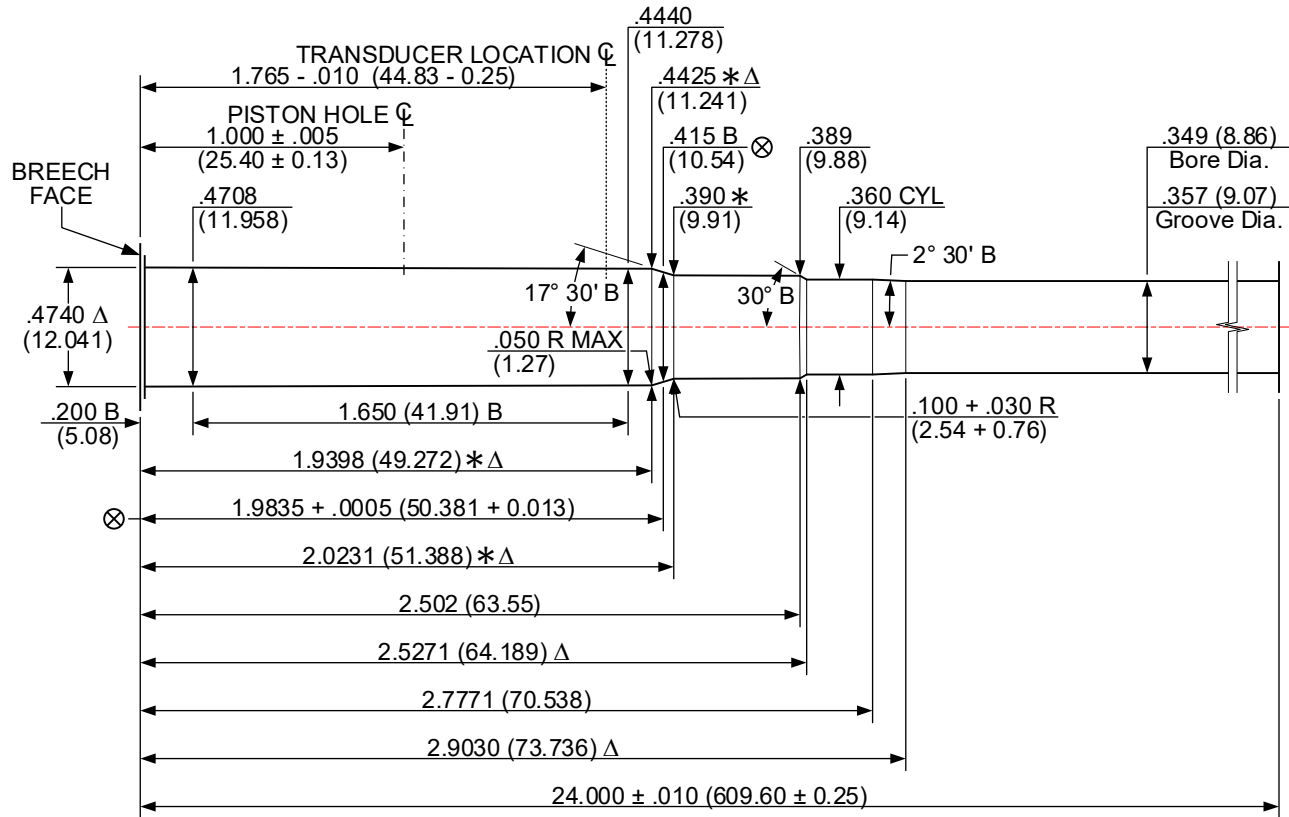

NUMBER OF GROOVES: 6
 WIDTH OF GROOVES: .130 + .002 (3.30 + 0.05)
 TWIST RATE: 16.00 (406.4) R.H.
 DIAMETER OF PISTON HOLE: .206 (5.23)
 TRANSDUCER DIAMETER: .250 (6.35)

LAND AND GROOVE DIMENSIONS TO BE
 WITHIN TOLERANCES THROUGHOUT
 LENGTH OF BARREL.

UNLESS OTHERWISE NOTED,
 ALL DIAMETERS +.0005 (0.013)
 LENGTH TOLERANCE + .005 (0.13)

DO NOT SCALE FROM DRAWING

NOTES:

B = BASIC

Δ = REFERENCE DIMENSION

⊗ = HEADSPACE DIMENSION

* DIMENSIONS ARE TO INTERSECTIONS OF LINES

(XX.XX) = MILLIMETERS

ALL CALCULATIONS APPLY AT MAXIMUM MATERIAL CONDITION (MMC)

350 LEGEND [350 LGND]
 ISSUED: 01/21/2019 V&P TEST BARREL REVISED: 06/04/2021

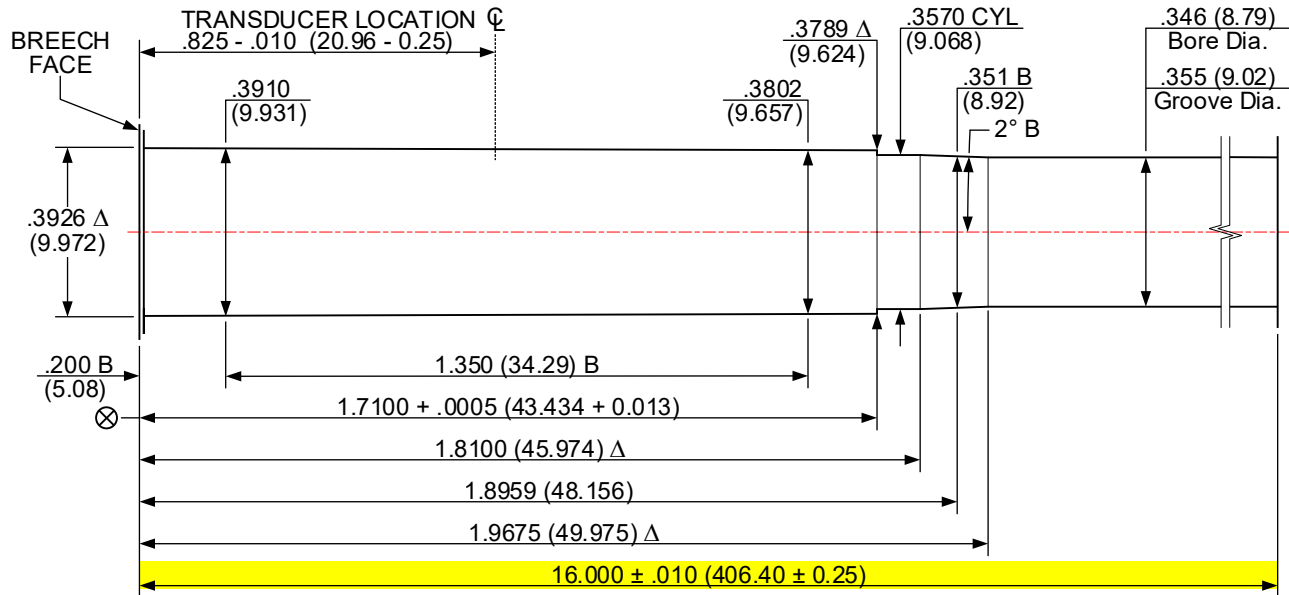

NUMBER OF GROOVES: 6
 WIDTH OF GROOVES: .100 + .002 (2.54 + 0.05)
 TWIST RATE: 16.00 (406.4) R.H.
 DIAMETER OF PISTON HOLE: Crusher pressures not established
 TRANSDUCER DIAMETER: .250 (6.35)

LAND AND GROOVE DIMENSIONS TO BE
 WITHIN TOLERANCES THROUGHOUT
 LENGTH OF BARREL.

UNLESS OTHERWISE NOTED,
 ALL DIAMETERS +.0005 (0.013)
 LENGTH TOLERANCE + .005 (0.13)

DO NOT SCALE FROM DRAWING

NOTES:

B = BASIC

Δ = REFERENCE DIMENSION

⊗ = HEADSPACE DIMENSION

* DIMENSIONS ARE TO INTERSECTIONS OF LINES

(XX.XX) = MILLIMETERS

ALL CALCULATIONS APPLY AT MAXIMUM MATERIAL CONDITION (MMC)

356 WINCHESTER [356 WIN]
 ISSUED: 11/08/1983 V&P TEST BARREL REVISED: 07/25/2023

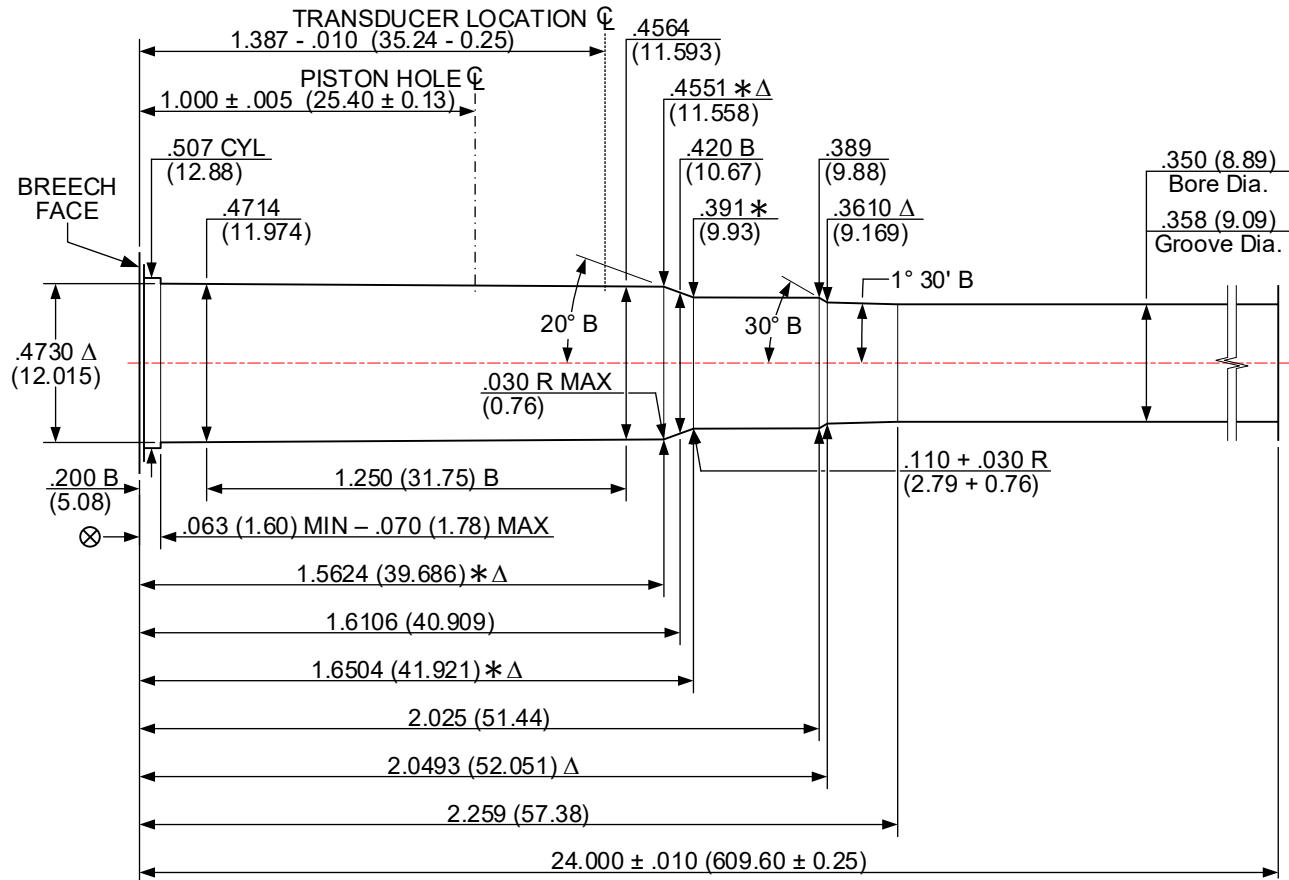

NUMBER OF GROOVES: 6
 WIDTH OF GROOVES: .1099 + .002 (2.791 + 0.05)
 TWIST RATE: 12.00 (304.8) R.H.
 DIAMETER OF PISTON HOLE: .206 (5.23)
 TRANSDUCER DIAMETER: .250 (6.53)

LAND AND GROOVE DIMENSIONS TO BE WITHIN TOLERANCES THROUGHOUT LENGTH OF BARREL.

UNLESS OTHERWISE NOTED, ALL DIAMETERS +.0005 (0.013) LENGTH TOLERANCE + .005 (0.13)

DO NOT SCALE FROM DRAWING

NOTES:

- B = BASIC
- Δ = REFERENCE DIMENSION
- * DIMENSIONS ARE TO INTERSECTIONS OF LINES
- ⊗ = HEADSPACE DIMENSION
- (XX.XX) = MILLIMETERS
- ALL CALCULATIONS APPLY AT MAXIMUM MATERIAL CONDITION (MMC)

358 WINCHESTER [358 WIN]
 ISSUED: 06/04/1998 V&P TEST BARREL REVISED: 07/25/2023

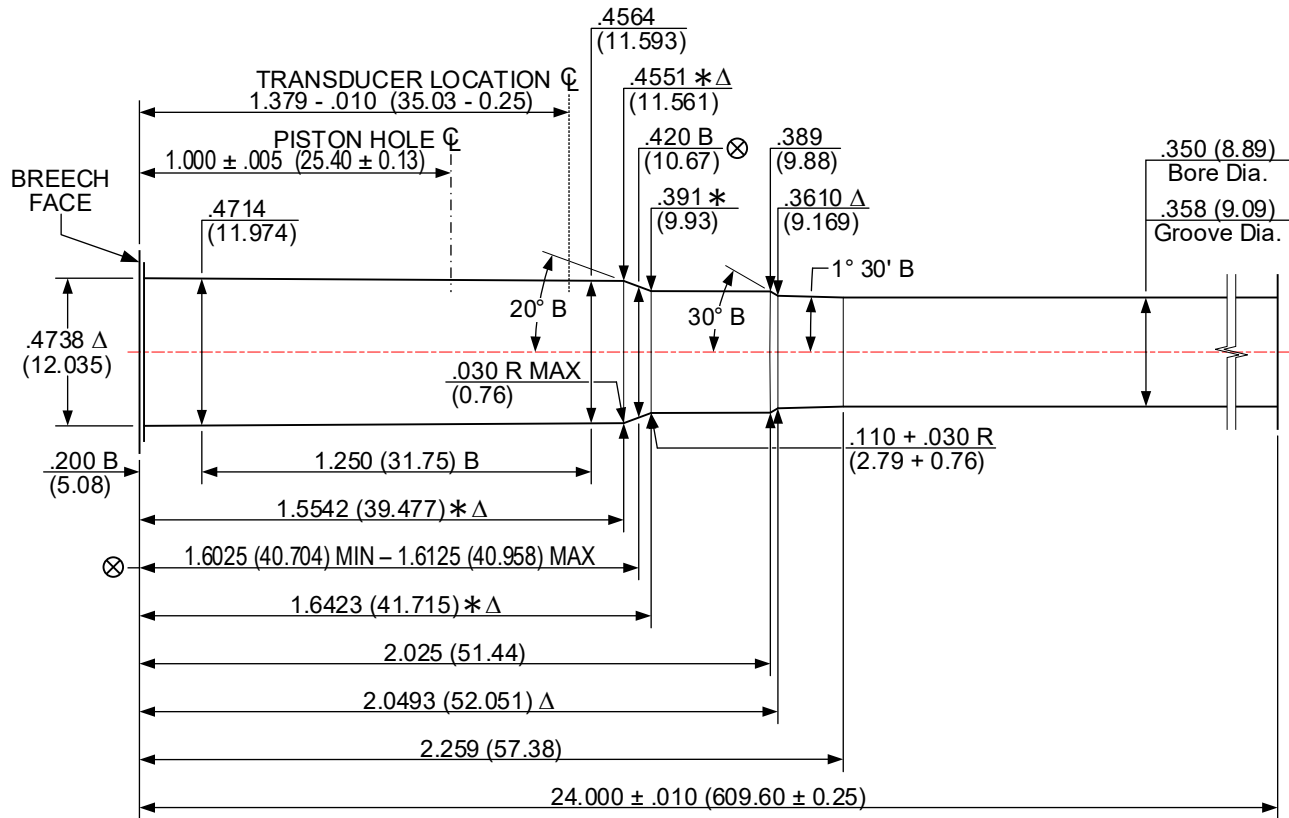

NUMBER OF GROOVES: 6
 WIDTH OF GROOVES: .1099 + .0020 (2.791 + 0.051)
 TWIST RATE: 12.00 (304.8) R.H.
 DIAMETER OF PISTON HOLE: .206 (5.23)
 TRANSDUCER DIAMETER: .250 (6.35)

LAND AND GROOVE DIMENSIONS TO BE
 WITHIN TOLERANCES THROUGHOUT
 LENGTH OF BARREL.

UNLESS OTHERWISE NOTED,
 ALL DIAMETERS +.0005 (0.013)
 LENGTH TOLERANCE + .005 (0.13)

DO NOT SCALE FROM DRAWING

NOTES:

B = BASIC

Δ = REFERENCE DIMENSION

⊗ = HEADSPACE DIMENSION

* DIMENSIONS ARE TO INTERSECTIONS OF LINES

(XX.XX) = MILLIMETERS

ALL CALCULATIONS APPLY AT MAXIMUM MATERIAL CONDITION (MMC)

360 BUCKHAMMER [360 BHRM]

ISSUED: 01/15/2023 V&P TEST BARREL REVISED: - / - / - - -

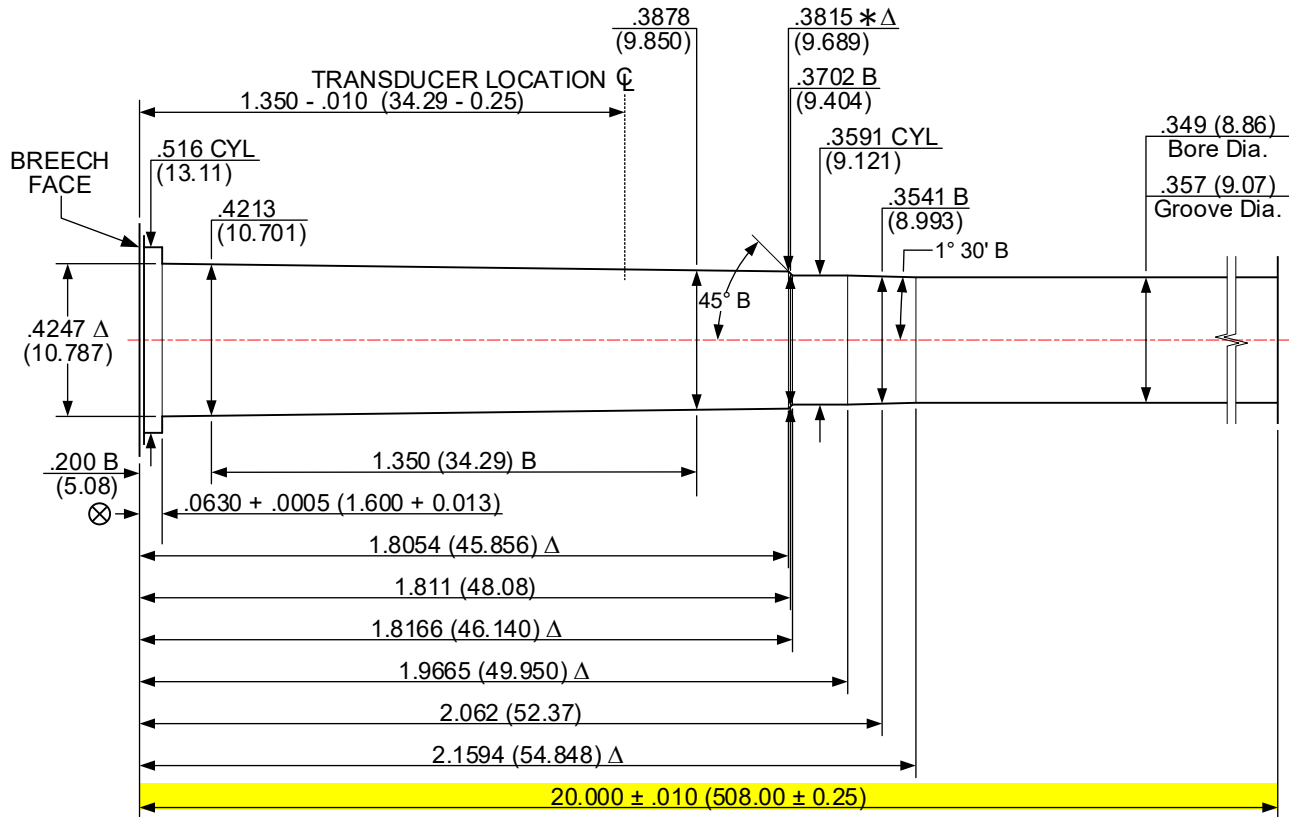

NUMBER OF GROOVES: 7
 WIDTH OF GROOVES: .115 + .002 (2.92 + 0.05)
 TWIST RATE: 12.00 (304.8) R.H.
 DIAMETER OF PISTON HOLE: Crusher pressures not established
 TRANSDUCER DIAMETER: .250 (6.35)

LAND AND GROOVE DIMENSIONS TO BE
 WITHIN TOLERANCES THROUGHOUT
 LENGTH OF BARREL.

UNLESS OTHERWISE NOTED,
 ALL DIAMETERS +.0005 (0.013)
 LENGTH TOLERANCE + .005 (0.13)

DO NOT SCALE FROM DRAWING

NOTES:

B = BASIC

Δ = REFERENCE DIMENSION

⊗ = HEADSPACE DIMENSION

* DIMENSIONS ARE TO INTERSECTIONS OF LINES

(XX.XX) = MILLIMETERS

ALL CALCULATIONS APPLY AT MAXIMUM MATERIAL CONDITION (MMC)

370 SAKO MAGNUM [370 SAKO MAG]
 ISSUED: 01/18/2011 V&P TEST BARREL REVISED: 10/11/2024

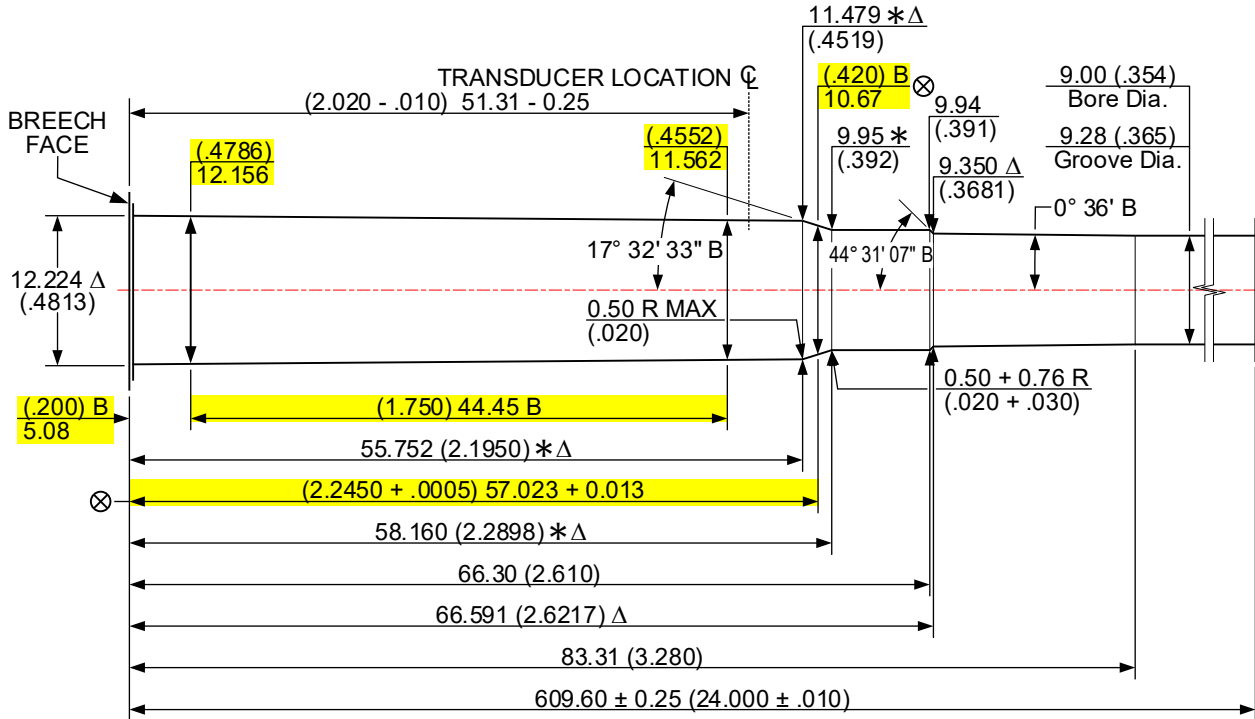

HIGHLIGHTED DIMENSIONS HAVE NO CORRESPONDING C.I.P. ANALOG. THE ENGLISH UNITS FOR THESE ARE THE ORIGINAL VALUES; METRIC VALUES ARE CALCULATED AND ROUNDED.

NUMBER OF GROOVES: 6
 WIDTH OF GROOVES: 3.14 + 0.05 (.124 + .002)
 TWIST RATE: 360.00 (14.173) R.H.
 DIAMETER OF PISTON HOLE: Crusher pressures not established
 TRANSDUCER DIAMETER: .250 (6.35)

LAND AND GROOVE DIMENSIONS TO BE WITHIN TOLERANCES THROUGHOUT LENGTH OF BARREL.

UNLESS OTHERWISE NOTED, ALL DIAMETERS +0.013 (.0005) LENGTH TOLERANCE +0.13 (.005)

DO NOT SCALE FROM DRAWING

NOTES:
 B = BASIC Δ = REFERENCE DIMENSION ⊗ = HEADSPACE DIMENSION
 * DIMENSIONS ARE TO INTERSECTIONS OF LINES (XX.XX) = MILLIMETERS
 ALL CALCULATIONS APPLY AT MAXIMUM MATERIAL CONDITION (MMC)

METRIC (9.3x66 SAKO)
 METRIC (9.3x66 SAKO)
 METRIC (9.3x66 SAKO)

NOTICE: This drawing is subject to change. Revisions, if applicable, are available at www.saami.org.

375 HOLLAND & HOLLAND MAGNUM [375 H&H MAG]
 ISSUED: 05/20/1980 V&P TEST BARREL REVISED: 07/26/2023

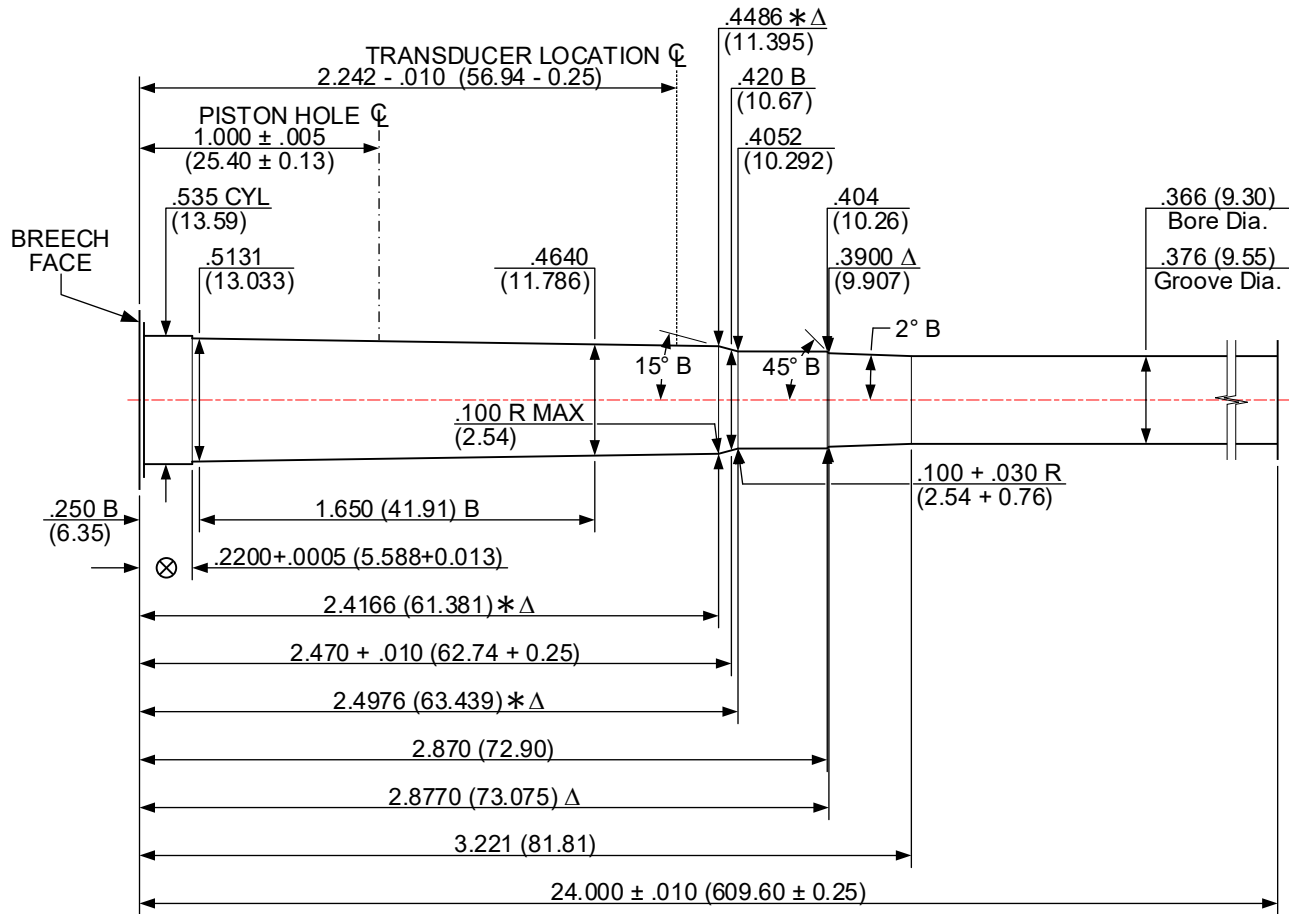

NUMBER OF GROOVES: 6
 WIDTH OF GROOVES: .115 + .002 (2.92 + 0.05)
 TWIST RATE: 12.00 (304.8) R.H.
 DIAMETER OF PISTON HOLE: .206 (5.23)
 TRANSDUCER DIAMETER: .250 (6.35)

LAND AND GROOVE DIMENSIONS TO BE
 WITHIN TOLERANCES THROUGHOUT
 LENGTH OF BARREL.

UNLESS OTHERWISE NOTED,
 ALL DIAMETERS +.0005 (0.013)
 LENGTH TOLERANCE + .005 (0.13)

DO NOT SCALE FROM DRAWING

NOTES:
 B = BASIC Δ = REFERENCE DIMENSION ⊗ = HEADSPACE DIMENSION
 * DIMENSIONS ARE TO INTERSECTIONS OF LINES (XX.XX) = MILLIMETERS
 ALL CALCULATIONS APPLY AT MAXIMUM MATERIAL CONDITION (MMC)

375 REMINGTON ULTRA MAGNUM [375 REM ULTRA MAG]
 ISSUED: 01/10/2001 V&P TEST BARREL REVISED: 07/26/2023

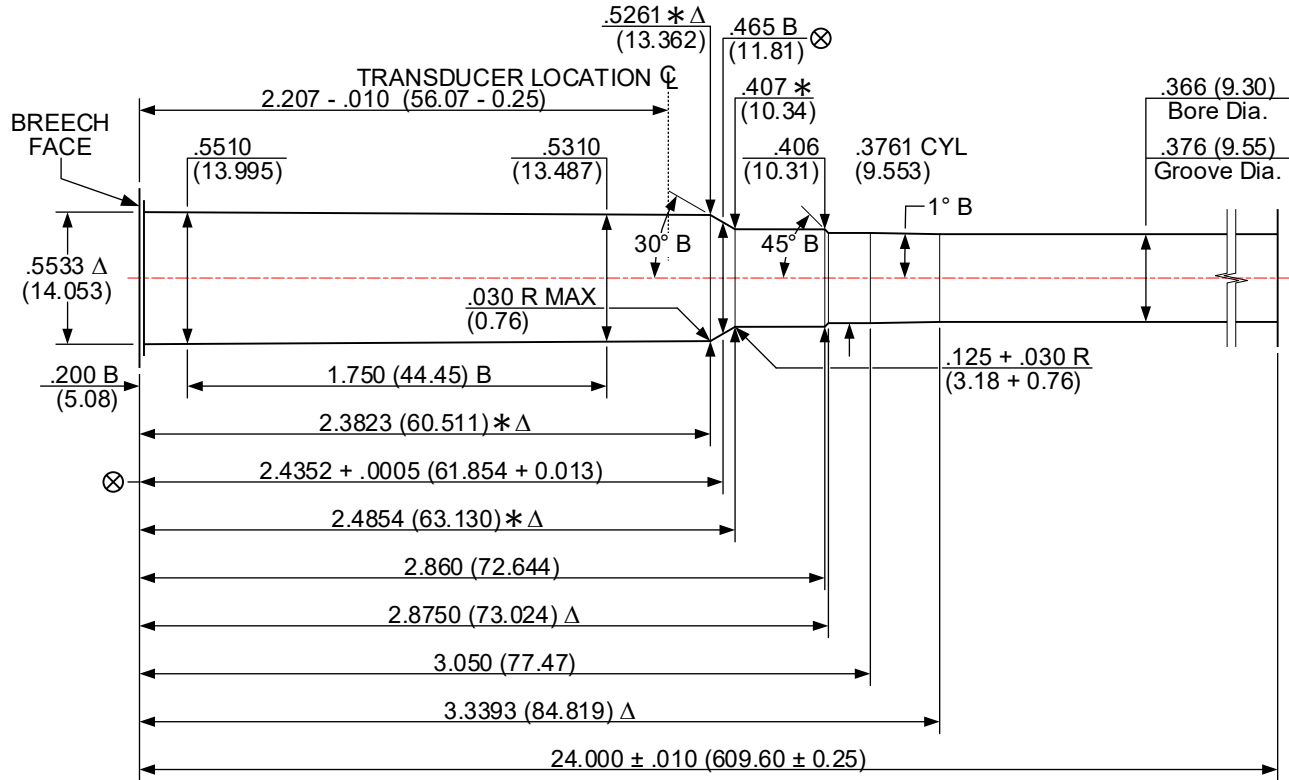

NUMBER OF GROOVES: 6
 WIDTH OF GROOVES: .115 + .002 (2.92 + 0.05)
 TWIST RATE: 12.00 (304.8) R.H.
 DIAMETER OF PISTON HOLE: Crusher pressures not established
 TRANSDUCER DIAMETER: .250 (6.35)

LAND AND GROOVE DIMENSIONS TO BE
 WITHIN TOLERANCES THROUGHOUT
 LENGTH OF BARREL.

UNLESS OTHERWISE NOTED,
 ALL DIAMETERS +.0005 (0.013)
 LENGTH TOLERANCE + .005 (0.13)

DO NOT SCALE FROM DRAWING

NOTES:
 B = BASIC Δ = REFERENCE DIMENSION ⊗ = HEADSPACE DIMENSION
 * DIMENSIONS ARE TO INTERSECTIONS OF LINES (XX.XX) = MILLIMETERS
 ALL CALCULATIONS APPLY AT MAXIMUM MATERIAL CONDITION (MMC)

375 RUGER [375 RUGER]
 ISSUED: 01/06/2009 V&P TEST BARREL REVISED: 07/26/2023

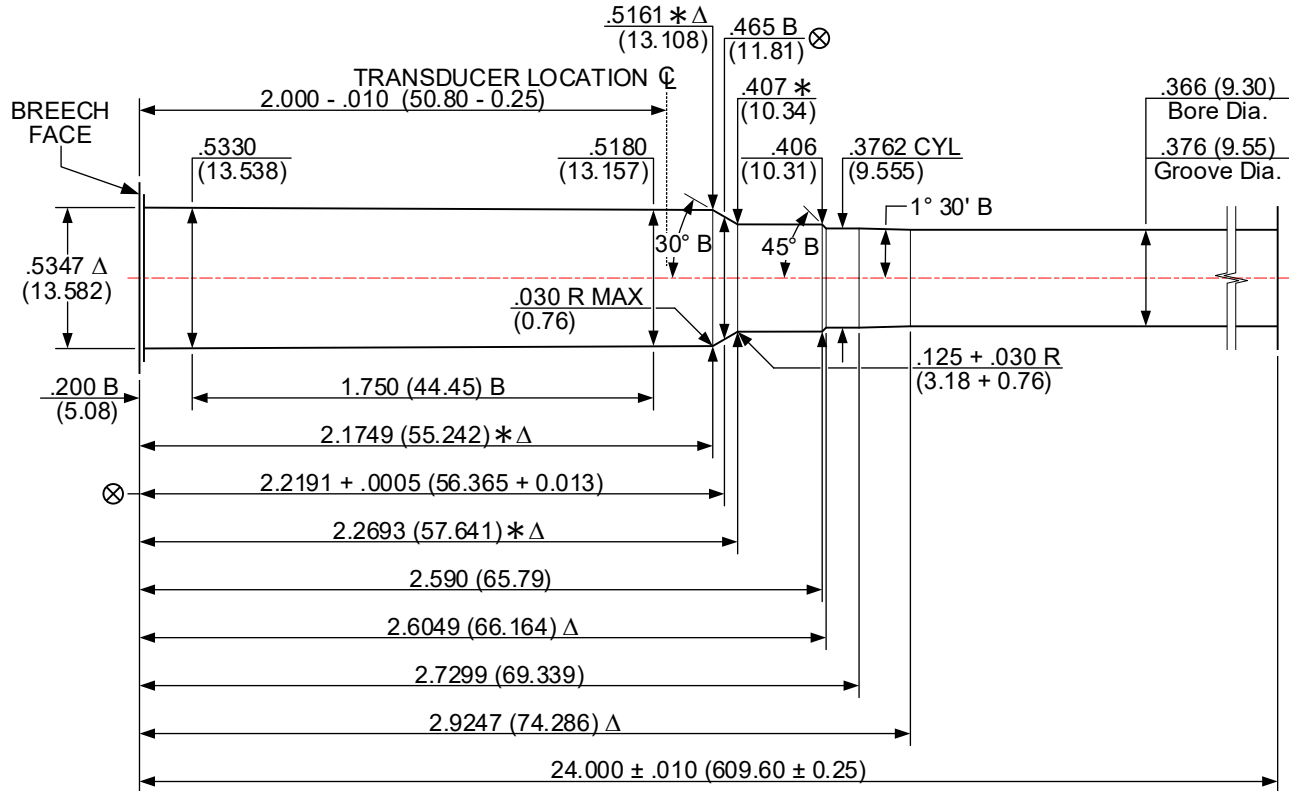

NUMBER OF GROOVES: 6
 WIDTH OF GROOVES: .115 + .002 (2.92 + 0.05)
 TWIST RATE: 12.00 (304.8) R.H.
 DIAMETER OF PISTON HOLE: Crusher pressures not established
 TRANSDUCER DIAMETER: .250 (6.35)

LAND AND GROOVE DIMENSIONS TO BE
 WITHIN TOLERANCES THROUGHOUT
 LENGTH OF BARREL.

UNLESS OTHERWISE NOTED,
 ALL DIAMETERS +.0005 (0.013)
 LENGTH TOLERANCE + .005 (0.13)

DO NOT SCALE FROM DRAWING

NOTES:

B = BASIC

Δ = REFERENCE DIMENSION

⊗ = HEADSPACE DIMENSION

* DIMENSIONS ARE TO INTERSECTIONS OF LINES

(XX.XX) = MILLIMETERS

ALL CALCULATIONS APPLY AT MAXIMUM MATERIAL CONDITION (MMC)

375 WINCHESTER [375 WIN]
 ISSUED: 05/20/1980 V&P TEST BARREL REVISED: 07/26/2023

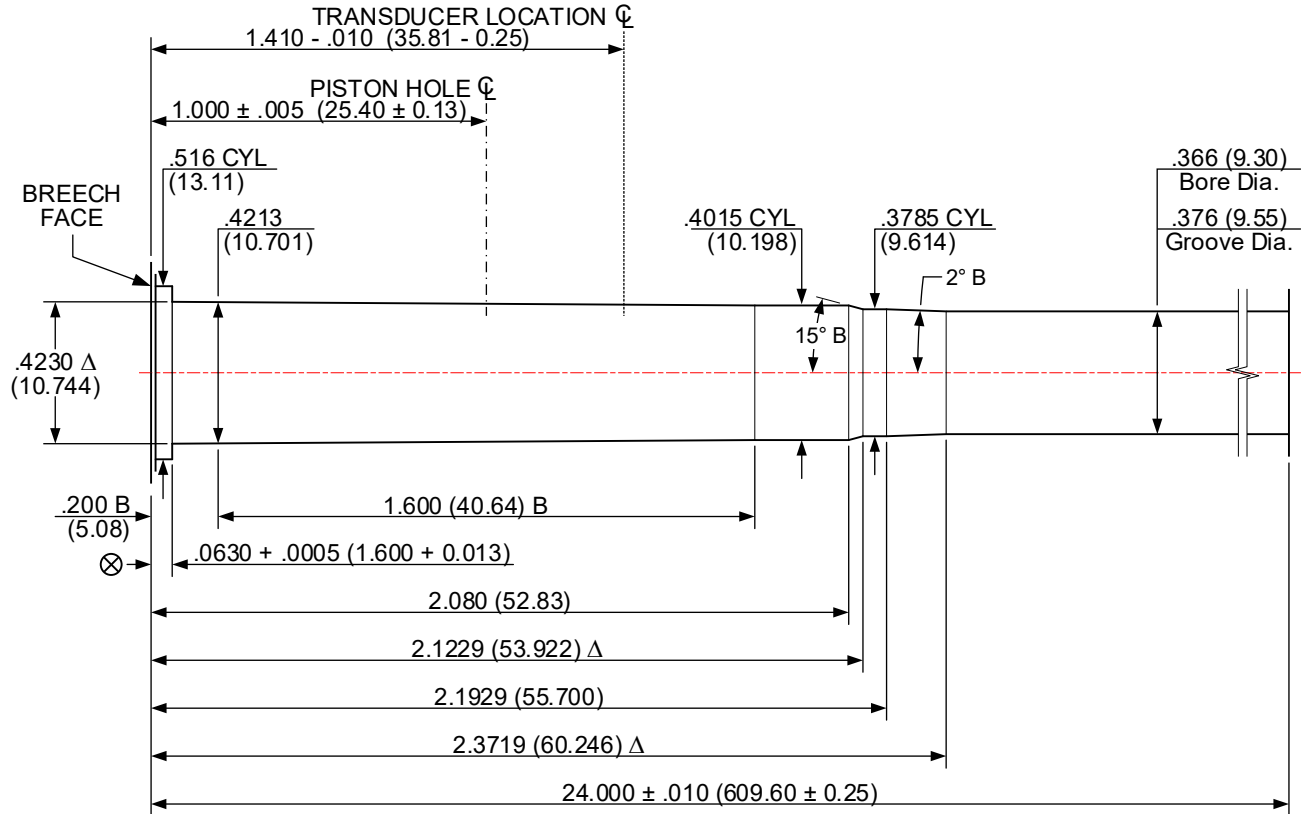

NUMBER OF GROOVES: 6
 WIDTH OF GROOVES: .115 + .002 (2.92 + 0.05)
 TWIST RATE: 12.00 (304.8) R.H.
 DIAMETER OF PISTON HOLE: .206 (5.23)
 TRANSDUCER DIAMETER: .250 (6.53)

LAND AND GROOVE DIMENSIONS TO BE
 WITHIN TOLERANCES THROUGHOUT
 LENGTH OF BARREL.

UNLESS OTHERWISE NOTED,
 ALL DIAMETERS +.0005 (0.013)
 LENGTH TOLERANCE + .005 (0.13)

DO NOT SCALE FROM DRAWING

NOTES:
 B = BASIC Δ = REFERENCE DIMENSION ⊗ = HEADSPACE DIMENSION
 * DIMENSIONS ARE TO INTERSECTIONS OF LINES (XX.XX) = MILLIMETERS
 ALL CALCULATIONS APPLY AT MAXIMUM MATERIAL CONDITION (MMC)

376 STEYR [376 STEYR]
 ISSUED: 06/13/2001 V&P TEST BARREL REVISED: 10/11/2024

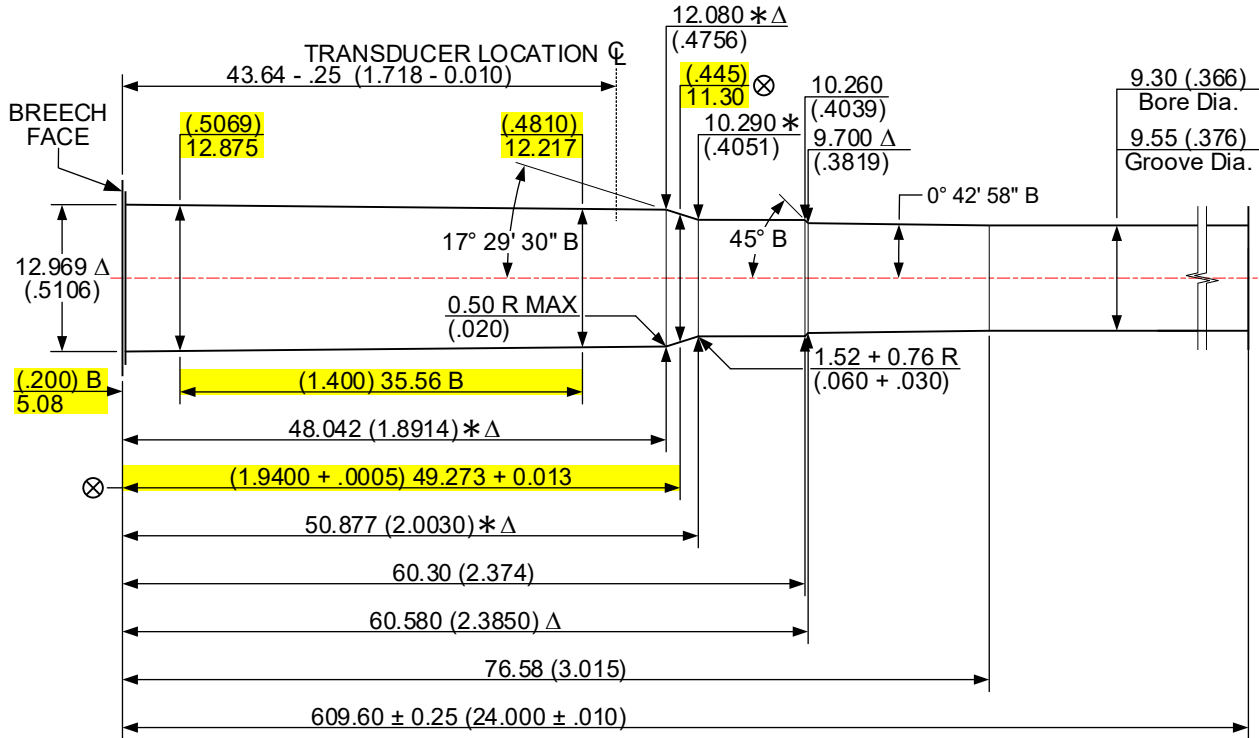

HIGHLIGHTED DIMENSIONS HAVE NO CORRESPONDING C.I.P. ANALOG. THE ENGLISH UNITS FOR THESE ARE THE ORIGINAL VALUES; METRIC VALUES ARE CALCULATED AND ROUNDED.

NUMBER OF GROOVES: 6
 WIDTH OF GROOVES: $2.92 + .05$ (0.115 + 0.002)
 TWIST RATE: 304.8 (12.00) R.H.
 DIAMETER OF PISTON HOLE: Crusher pressures not established
 TRANSDUCER DIAMETER: 6.35 (.250)

LAND AND GROOVE DIMENSIONS TO BE WITHIN TOLERANCES THROUGHOUT LENGTH OF BARREL.

UNLESS OTHERWISE NOTED, ALL DIAMETERS +0.013 (0.0005) LENGTH TOLERANCE +0.13 (0.005)

DO NOT SCALE FROM DRAWING

NOTES:

B = BASIC

Δ = REFERENCE DIMENSION

⊗ = HEADSPACE DIMENSION

* DIMENSIONS ARE TO INTERSECTIONS OF LINES

(XX.XX) = MILLIMETERS

ALL CALCULATIONS APPLY AT MAXIMUM MATERIAL CONDITION (MMC)

METRIC METRIC METRIC METRIC METRIC

38-40 WINCHESTER V&P TEST BARREL
 ISSUED: 05/20/1980 V&P TEST BARREL REVISED: 10/05/2023

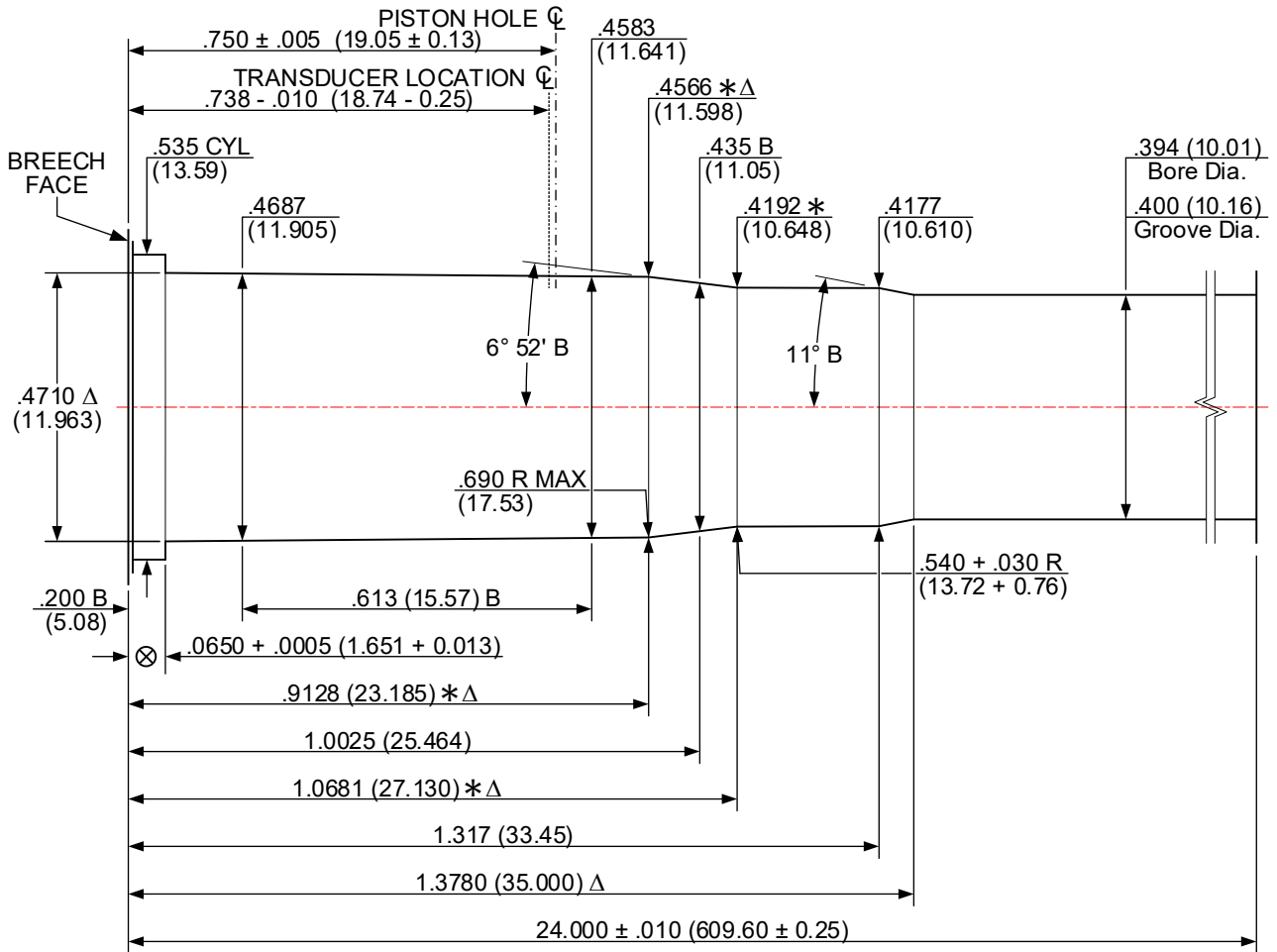

NUMBER OF GROOVES: 6
 WIDTH OF GROOVES: $.1237 + .0020$ (3.142 + 0.051)
 TWIST RATE: 36.00 (914.4) R.H.
 DIAMETER OF PISTON HOLE: .146 (3.71)
 TRANSDUCER DIAMETER: .250 (6.35)

LAND AND GROOVE DIMENSIONS TO BE
 WITHIN TOLERANCES THROUGHOUT
 LENGTH OF BARREL.

UNLESS OTHERWISE NOTED,
 ALL DIAMETERS $+.0005$ (0.013)
 LENGTH TOLERANCE $+.005$ (0.13)

DO NOT SCALE FROM DRAWING

NOTES:

B = BASIC

Δ = REFERENCE DIMENSION

\otimes = HEADSPACE DIMENSION

* DIMENSIONS ARE TO INTERSECTIONS OF LINES

(XX.XX) = MILLIMETERS

ALL CALCULATIONS APPLY AT MAXIMUM MATERIAL CONDITION (MMC)

38-55 WINCHESTER [38-55 WIN]
 ISSUED: 05/20/1980 V&P TEST BARREL REVISED: 07/27/2023

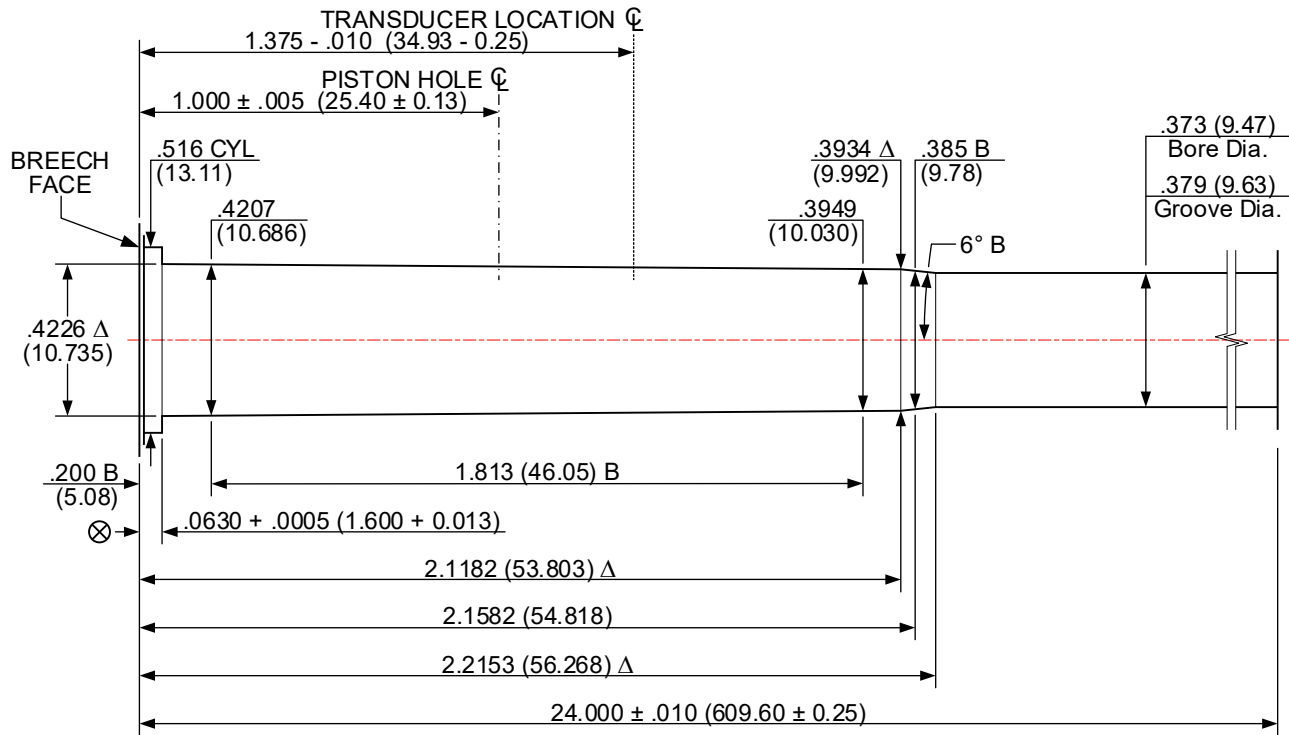

NUMBER OF GROOVES: 6
 WIDTH OF GROOVES: $.1171 + .002$ (2.974 + 0.051)
 TWIST RATE: 18.00 (457.2) R.H.
 DIAMETER OF PISTON HOLE: $.206$ (5.23)
 TRANSUDER DIAMETER: $.250$ (6.53)

LAND AND GROOVE DIMENSIONS TO BE
 WITHIN TOLERANCES THROUGHOUT
 LENGTH OF BARREL.

UNLESS OTHERWISE NOTED,
 ALL DIAMETERS $+0.005$ (0.013)
 LENGTH TOLERANCE $+ .005$ (0.13)

DO NOT SCALE FROM DRAWING

NOTES:
 B = BASIC Δ = REFERENCE DIMENSION \otimes = HEADSPACE DIMENSION
 * DIMENSIONS ARE TO INTERSECTIONS OF LINES (XX.XX) = MILLIMETERS
 ALL CALCULATIONS APPLY AT MAXIMUM MATERIAL CONDITION (MMC)

400 LEGEND [400 LGND]
 ISSUED: 01/15/2023 V&P TEST BARREL REVISED: - / - / - - -

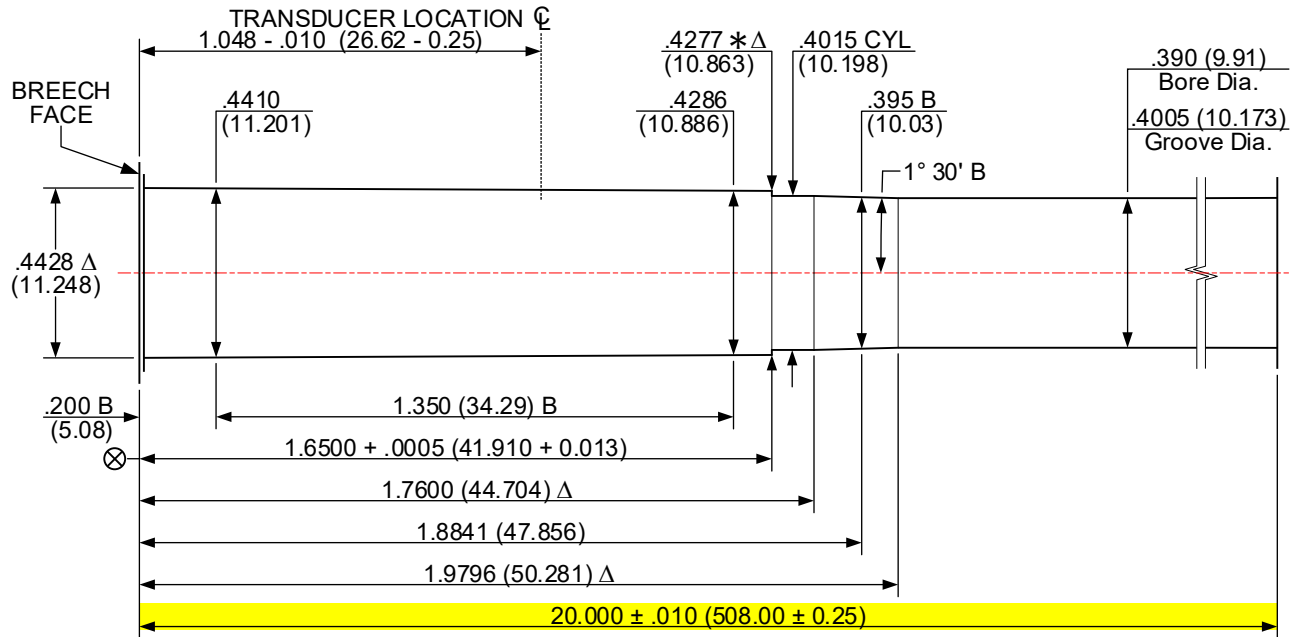

NUMBER OF GROOVES: 6
 WIDTH OF GROOVES: .120 + .002 (3.05 + 0.05)
 TWIST RATE: 16.00 (406.4) R.H.
 DIAMETER OF PISTON HOLE: Crusher pressures not established
 TRANSDUCER DIAMETER: .250 (6.35)

LAND AND GROOVE DIMENSIONS TO BE
 WITHIN TOLERANCES THROUGHOUT
 LENGTH OF BARREL.

UNLESS OTHERWISE NOTED,
 ALL DIAMETERS +.0005 (0.013)
 LENGTH TOLERANCE + .005 (0.13)

DO NOT SCALE FROM DRAWING

NOTES:
 B = BASIC Δ = REFERENCE DIMENSION ⊗ = HEADSPACE DIMENSION
 * DIMENSIONS ARE TO INTERSECTIONS OF LINES (XX.XX) = MILLIMETERS
 ALL CALCULATIONS APPLY AT MAXIMUM MATERIAL CONDITION (MMC)

405 WINCHESTER [405 WIN]

ISSUED: 01/24/1998 V&P TEST BARREL REVISED: 07/31/2023

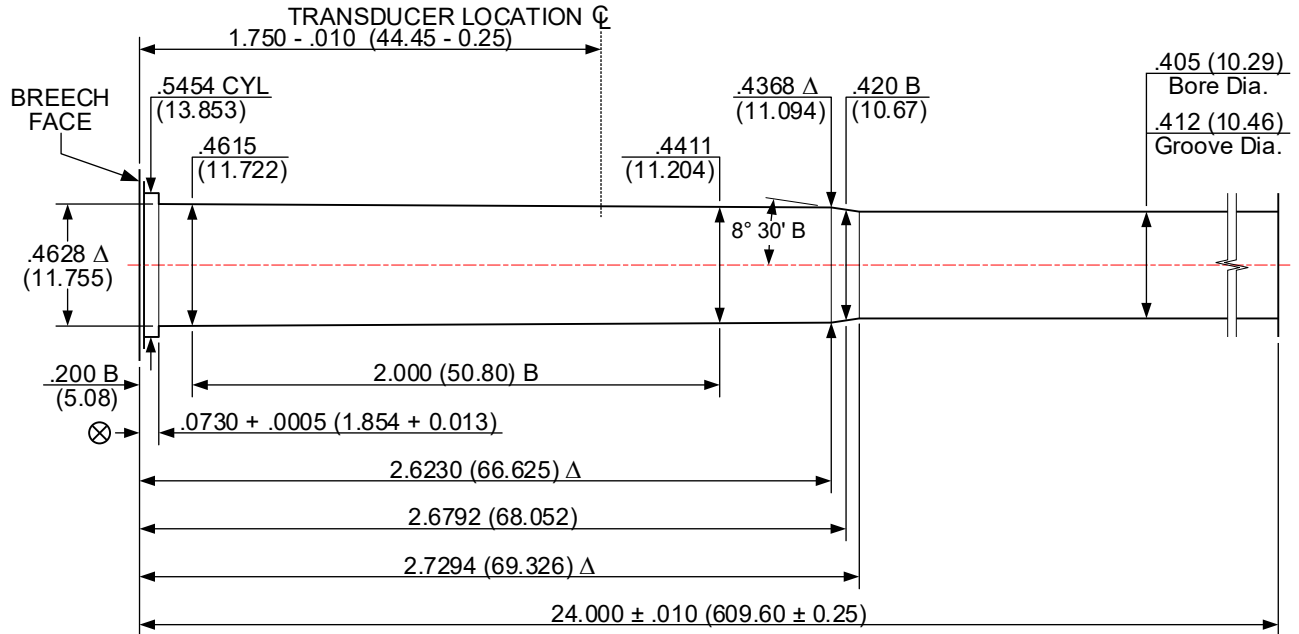

NUMBER OF GROOVES: 6
 WIDTH OF GROOVES: .127 + .002 (3.23 + 0.05)
 TWIST RATE: 14.00 (255.6) R.H.
 DIAMETER OF PISTON HOLE: Crusher pressures not established
 TRANSDUCER DIAMETER: .250 (6.53)

LAND AND GROOVE DIMENSIONS TO BE
 WITHIN TOLERANCES THROUGHOUT
 LENGTH OF BARREL.

UNLESS OTHERWISE NOTED,
 ALL DIAMETERS +.0005 (0.013)
 LENGTH TOLERANCE + .005 (0.13)

DO NOT SCALE FROM DRAWING

NOTES:

B = BASIC

Δ = REFERENCE DIMENSION

⊗ = HEADSPACE DIMENSION

* DIMENSIONS ARE TO INTERSECTIONS OF LINES

(XX.XX) = MILLIMETERS

ALL CALCULATIONS APPLY AT MAXIMUM MATERIAL CONDITION (MMC)

416 REMINGTON MAGNUM [416 REM MAG]
 ISSUED: 04/10/1989 V&P TEST BARREL REVISED: 07/31/2023

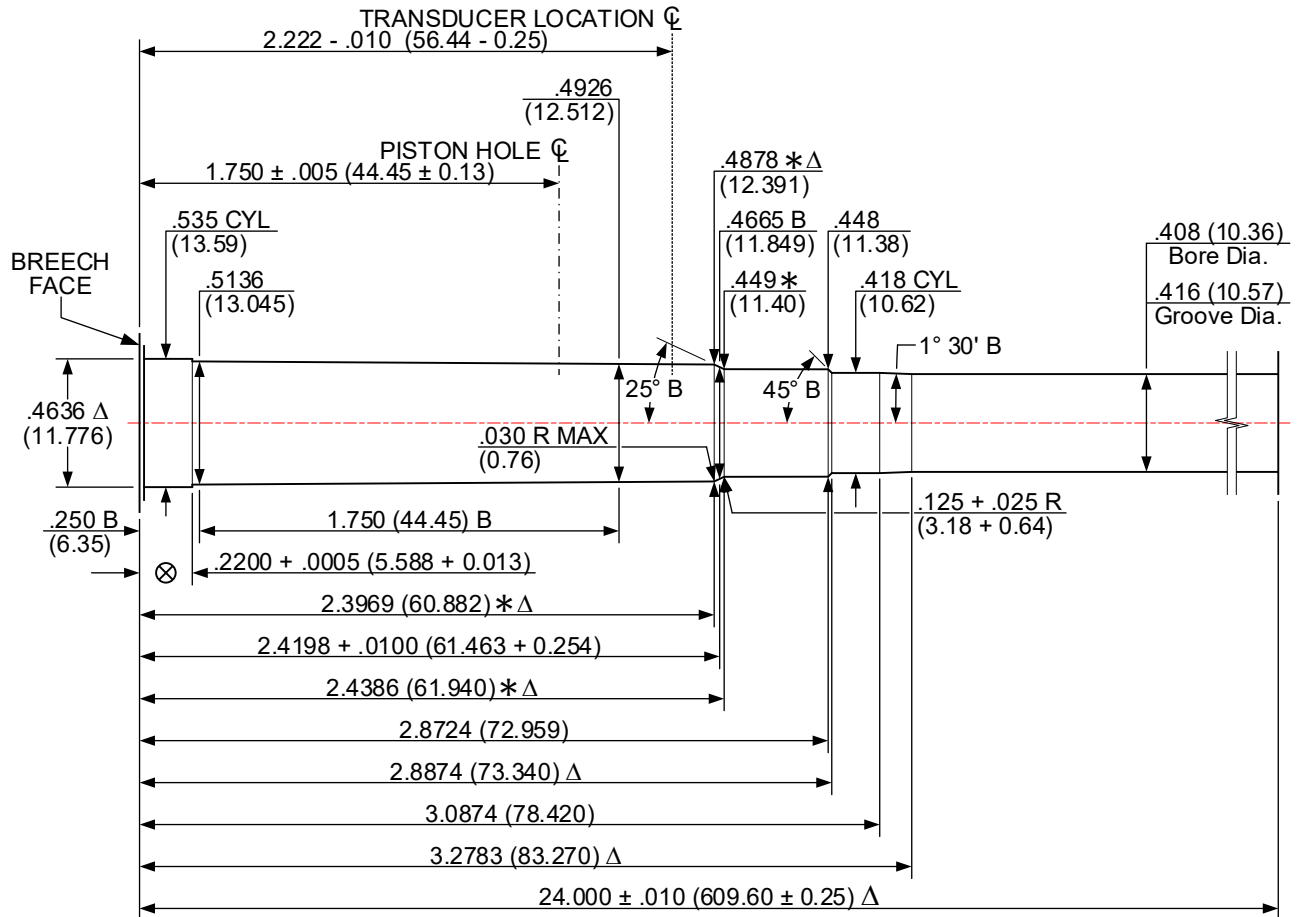

NUMBER OF GROOVES: 6
 WIDTH OF GROOVES: .128 + .002 (3.25 + 0.05)
 TWIST RATE: 14.00 (355.6) R.H.
 DIAMETER OF PISTON HOLE: .206 (5.23)
 TRANSDUCER DIAMETER: .250 (6.35)

LAND AND GROOVE DIMENSIONS TO BE
 WITHIN TOLERANCES THROUGHOUT
 LENGTH OF BARREL.

UNLESS OTHERWISE NOTED,
 ALL DIAMETERS +.0005 (0.013)
 LENGTH TOLERANCE + .005 (0.13)

DO NOT SCALE FROM DRAWING

NOTES:

B = BASIC

Δ = REFERENCE DIMENSION

⊗ = HEADSPACE DIMENSION

* DIMENSIONS ARE TO INTERSECTIONS OF LINES

(XX.XX) = MILLIMETERS

ALL CALCULATIONS APPLY AT MAXIMUM MATERIAL CONDITION (MMC)

416 RUGER [416 RUGER]
 ISSUED: 06/17/2009 V&P TEST BARREL REVISED: 08/01/2023

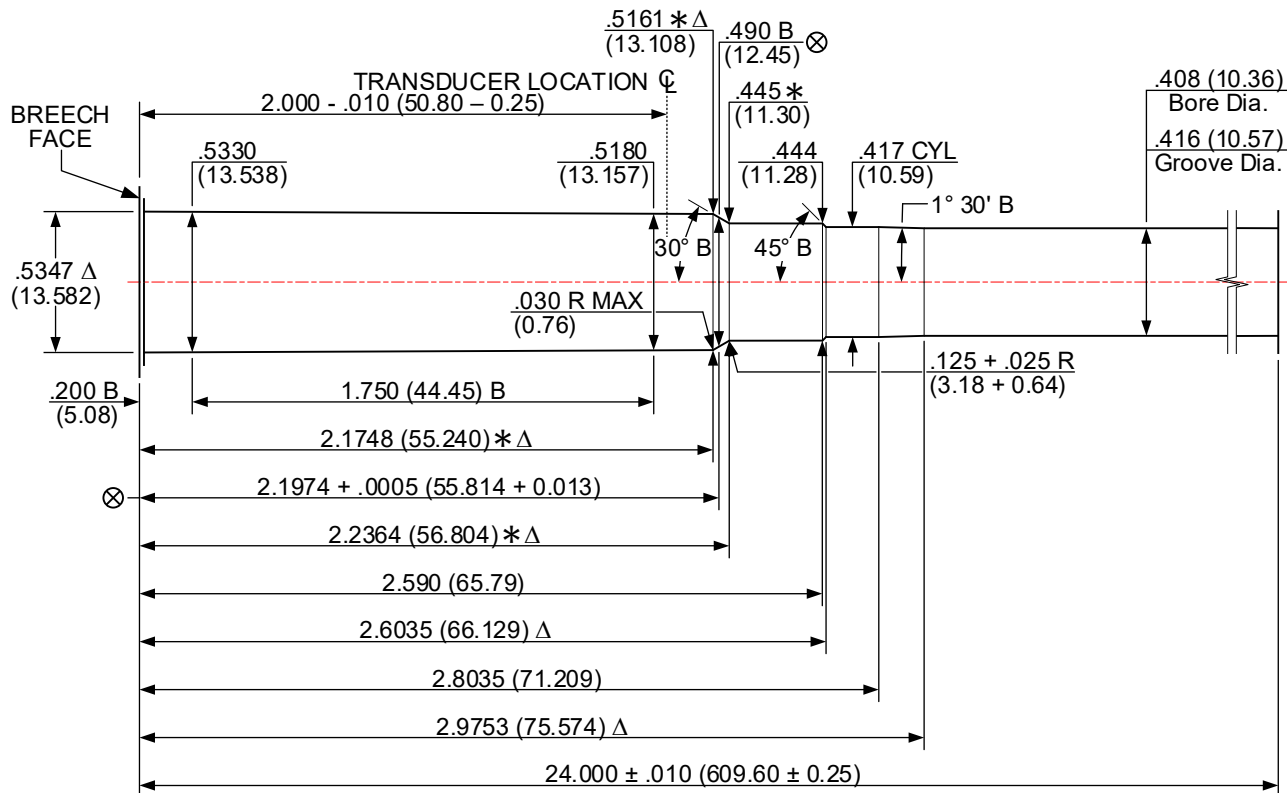

NUMBER OF GROOVES: 6
 WIDTH OF GROOVES: .128 + .002 (3.25 + 0.05)
 TWIST RATE: 14.00 (355.6) R.H.
 DIAMETER OF PISTON HOLE: Crusher pressures not established.
 TRANSDUCER DIAMETER: .250 (6.35)

LAND AND GROOVE DIMENSIONS TO BE
 WITHIN TOLERANCES THROUGHOUT
 LENGTH OF BARREL.

UNLESS OTHERWISE NOTED,
 ALL DIAMETERS +.0005 (0.013)
 LENGTH TOLERANCE + .005 (0.13)

DO NOT SCALE FROM DRAWING

NOTES:

B = BASIC

Δ = REFERENCE DIMENSION

⊗ = HEADSPACE DIMENSION

* DIMENSIONS ARE TO INTERSECTIONS OF LINES

(XX.XX) = MILLIMETERS

ALL CALCULATIONS APPLY AT MAXIMUM MATERIAL CONDITION (MMC)

416 WEATHERBY MAGNUM [416 WBY MAG]
 ISSUED: 01/12/1994 V&P TEST BARREL REVISED: 01/21/2024

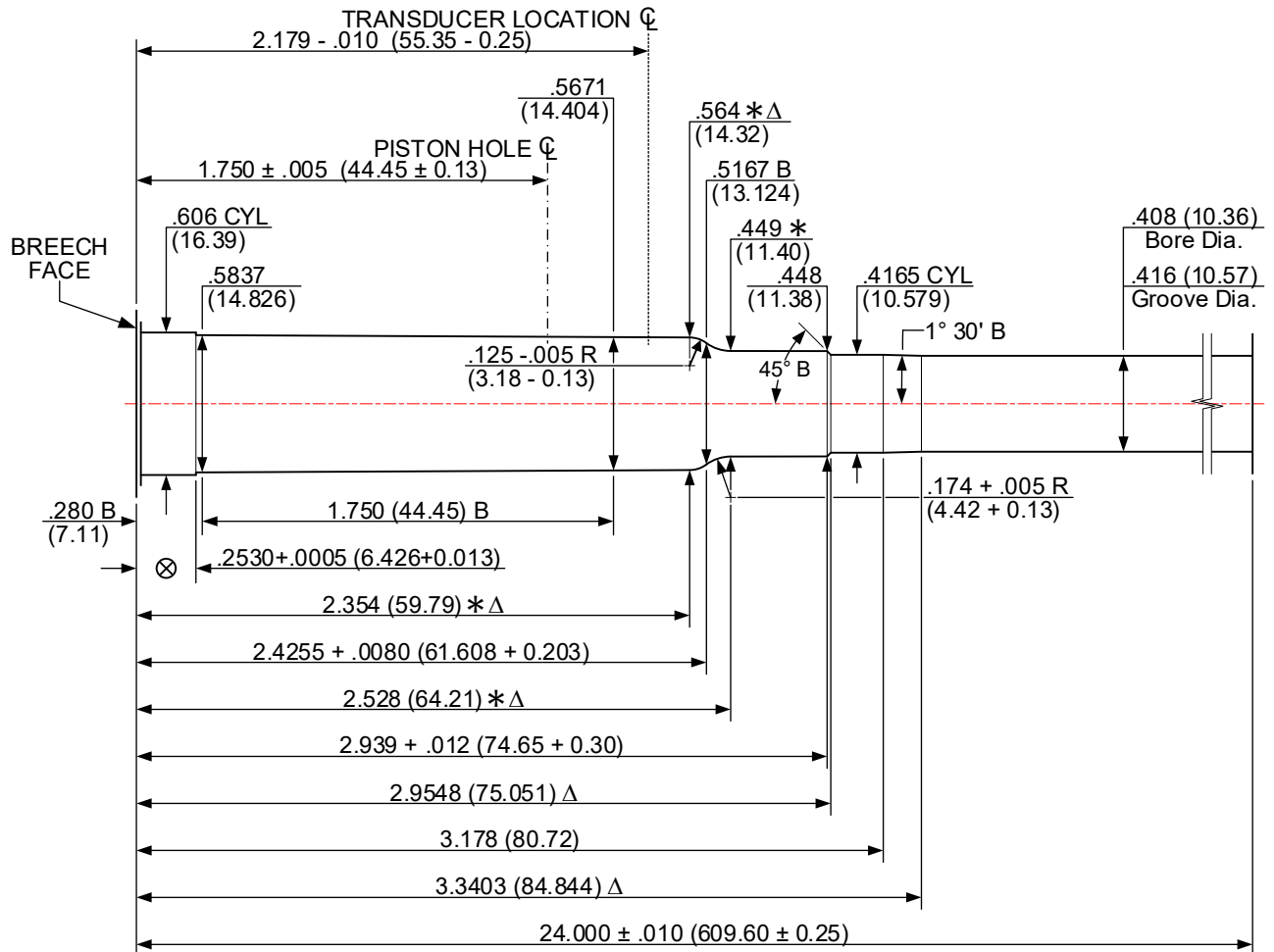

NUMBER OF GROOVES: 6
 WIDTH OF GROOVES: .127 + .002 (3.23 + 0.05)
 TWIST RATE: 14.00 (355.6) R.H.
 DIAMETER OF PISTON HOLE: .206 (5.23)
 TRANSDUCER DIAMETER: .250 (6.35)

LAND AND GROOVE DIMENSIONS TO BE
 WITHIN TOLERANCES THROUGHOUT
 LENGTH OF BARREL.

UNLESS OTHERWISE NOTED,
 ALL DIAMETERS +.0005 (0.013)
 LENGTH TOLERANCE + .005 (0.13)

DO NOT SCALE FROM DRAWING

NOTES:

B = BASIC

Δ = REFERENCE DIMENSION

\otimes = HEADSPACE DIMENSION

* DIMENSIONS ARE TO INTERSECTIONS OF LINES

(XX.XX) = MILLIMETERS

ALL CALCULATIONS APPLY AT MAXIMUM MATERIAL CONDITION (MMC)

44 REMINGTON MAGNUM [44 REM MAG]
V&P TEST BARREL
RIFLE

ISSUED: 05/20/1980

REVISED: 08/01/2023

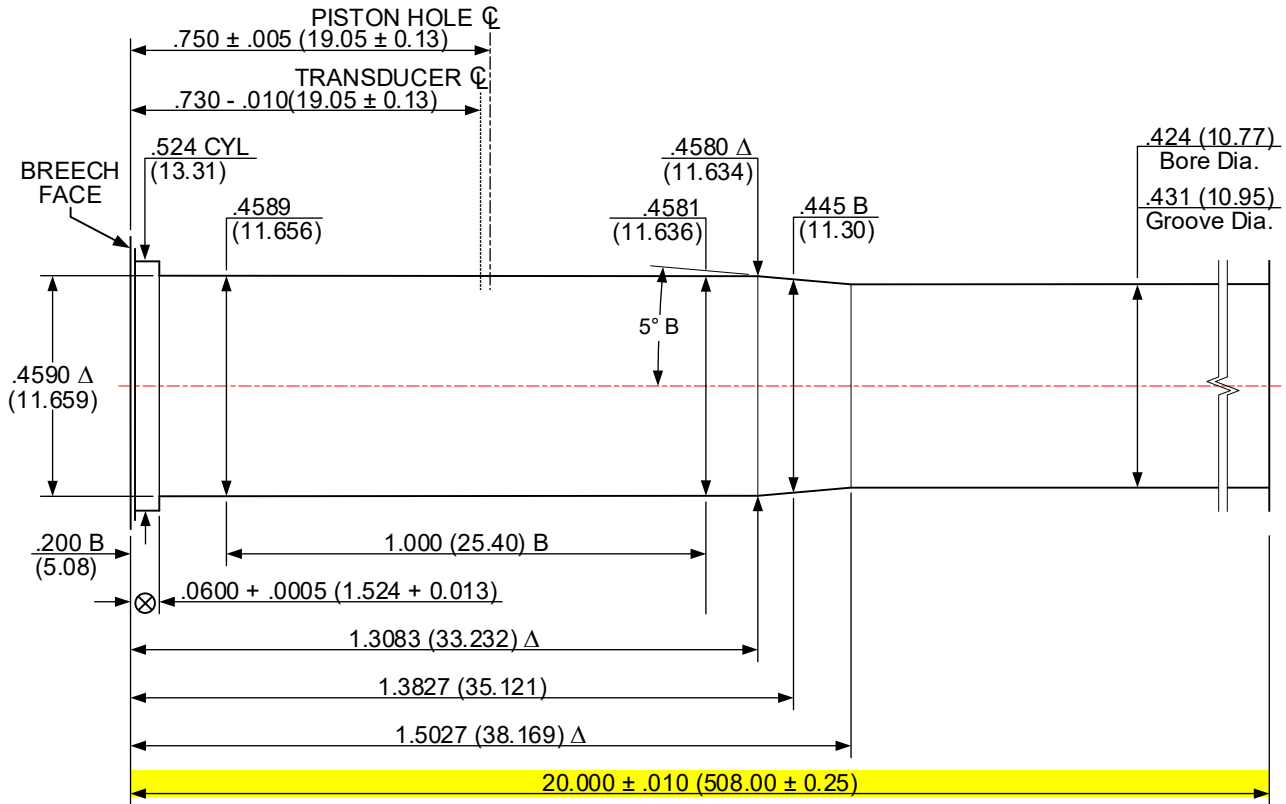

NUMBER OF GROOVES: 12
 WIDTH OF GROOVES: $.055 + .002$ (1.40 + 0.05)
 TWIST RATE: 38.00 (965.2) R.H.
 DIAMETER OF PISTON HOLE: $.206$ (5.23)
 TRANSDUCER DIAMETER: $.250$ (6.35)

LAND AND GROOVE DIMENSIONS TO BE
 WITHIN TOLERANCES THROUGHOUT
 LENGTH OF BARREL.

UNLESS OTHERWISE NOTED,
 ALL DIAMETERS $+ .0005$ (0.013)
 LENGTH TOLERANCE $+ .005$ (0.13)

DO NOT SCALE FROM DRAWING

NOTES:

B = BASIC

Δ = REFERENCE DIMENSION

\otimes = HEADSPACE DIMENSION

* DIMENSIONS ARE TO INTERSECTIONS OF LINES

(XX.XX) = MILLIMETERS

ALL CALCULATIONS APPLY AT MAXIMUM MATERIAL CONDITION (MMC)

NOTICE: This drawing is subject to change.
 Revisions, if applicable, are available at www.saami.org.

44-40 WINCHESTER [44-40 WIN]
 ISSUED: 05/20/1980 V&P TEST BARREL REVISED: 08/01/2023

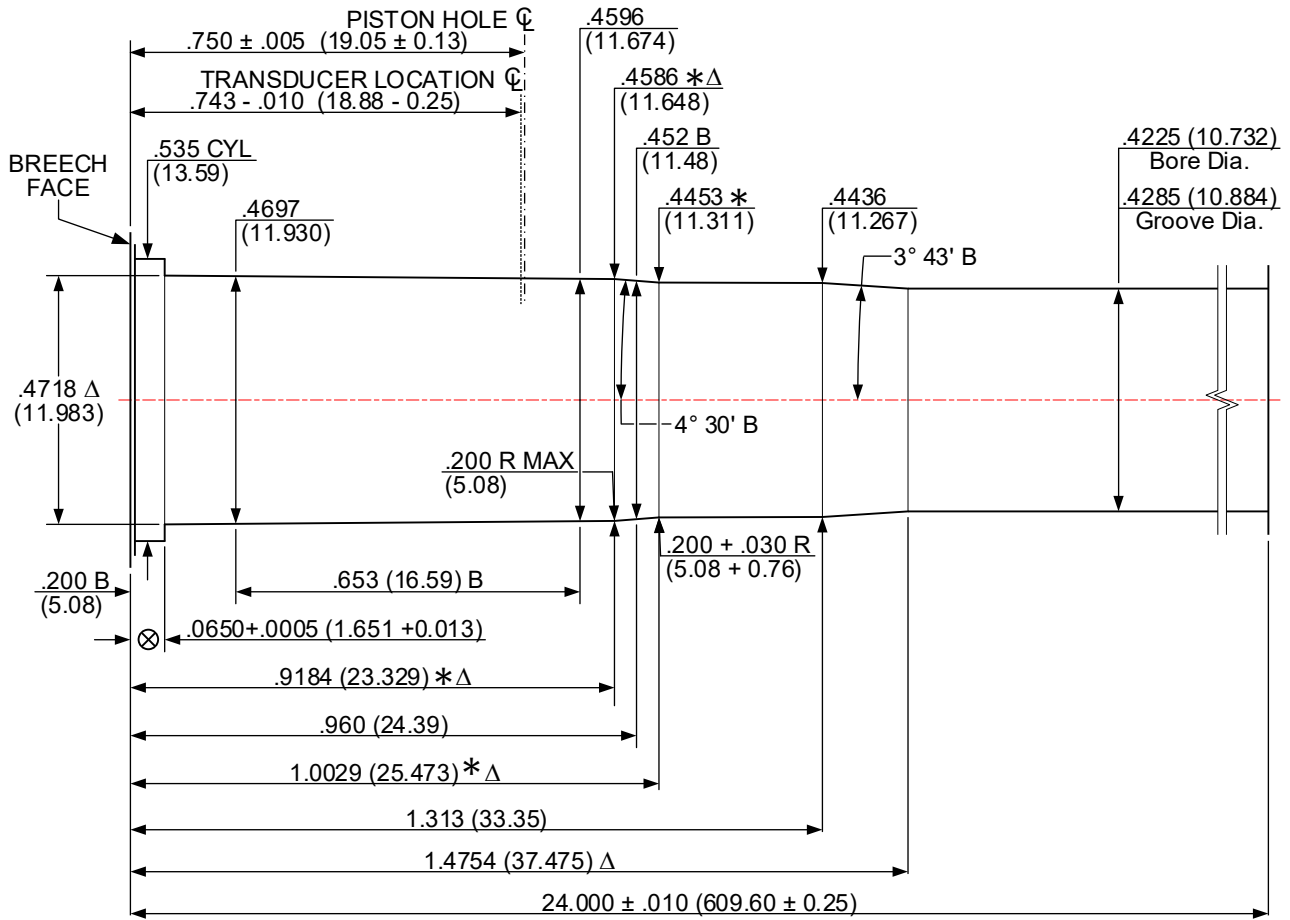

NUMBER OF GROOVES: 6
 WIDTH OF GROOVES: .1327 + .0020 (3.371 + 0.051)
 TWIST RATE: 36.00 (914.4) R.H.
 DIAMETER OF PISTON HOLE: .206 (5.23)
 TRANSDUCER DIAMETER: .250 (6.53)

LAND AND GROOVE DIMENSIONS TO BE
 WITHIN TOLERANCES THROUGHOUT
 LENGTH OF BARREL.

UNLESS OTHERWISE NOTED,
 ALL DIAMETERS +.0005 (0.013)
 LENGTH TOLERANCE + .005 (0.13)

DO NOT SCALE FROM DRAWING

NOTES:

B = BASIC

Δ = REFERENCE DIMENSION

⊗ = HEADSPACE DIMENSION

* DIMENSIONS ARE TO INTERSECTIONS OF LINES

(XX.XX) = MILLIMETERS

ALL CALCULATIONS APPLY AT MAXIMUM MATERIAL CONDITION (MMC)

444 MARLIN [444 MAR]
ISSUED: 05/20/1980 **V&P TEST BARREL** **REVISED: 08/01/2023**

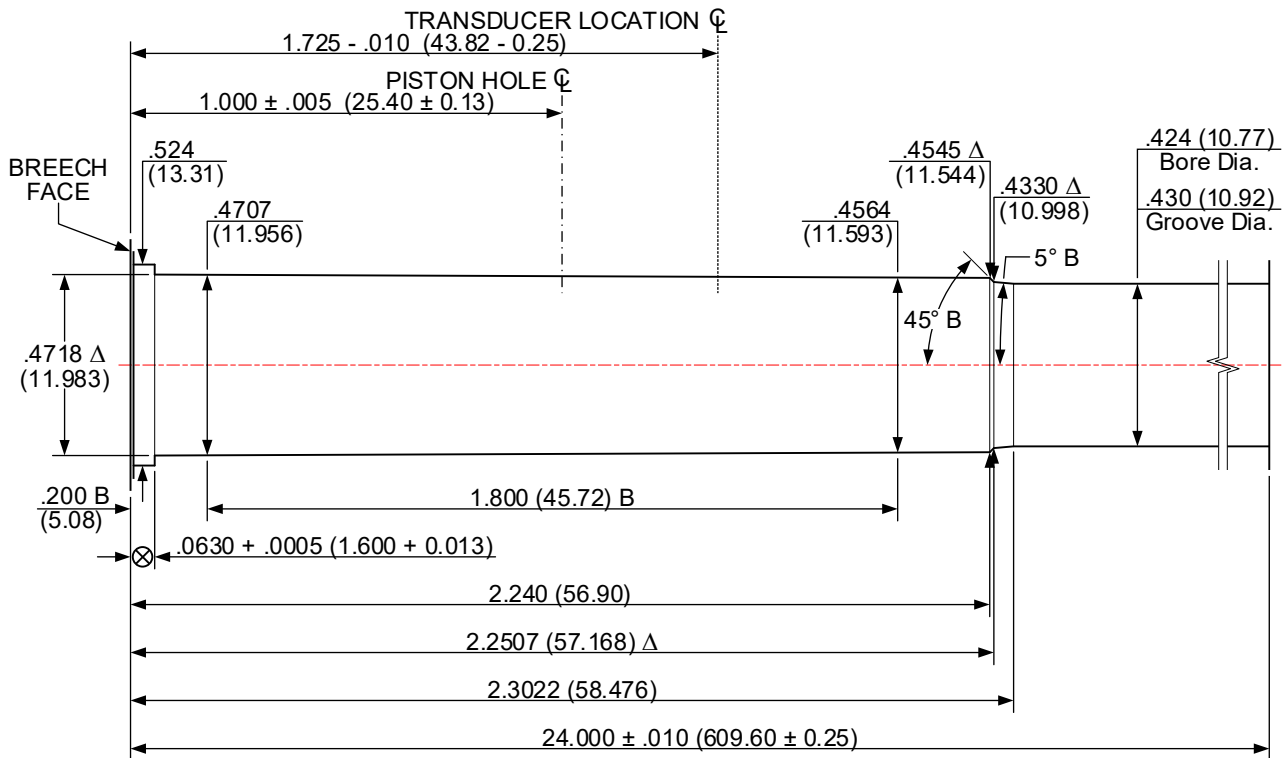

NUMBER OF GROOVES: 12
 WIDTH OF GROOVES: .062 + .002 (1.57 + 0.05)
 TWIST RATE: 38.00 (965.2) R.H.
 DIAMETER OF PISTON HOLE: .206 (5.23)
 TRANSDUCER DIAMETER: .250 (6.53)

LAND AND GROOVE DIMENSIONS TO BE
 WITHIN TOLERANCES THROUGHOUT
 LENGTH OF BARREL.

UNLESS OTHERWISE NOTED,
 ALL DIAMETERS +.0005 (0.013)
 LENGTH TOLERANCE + .005 (0.13)

DO NOT SCALE FROM DRAWING

NOTES:

B = BASIC

Δ = REFERENCE DIMENSION

⊗ = HEADSPACE DIMENSION

* DIMENSIONS ARE TO INTERSECTIONS OF LINES

(XX.XX) = MILLIMETERS

ALL CALCULATIONS APPLY AT MAXIMUM MATERIAL CONDITION (MMC)

45-70 GOVERNMENT [45-70 GOVT]

ISSUED: 05/20/1980 V&P TEST BARREL REVISED: 08/02/2023

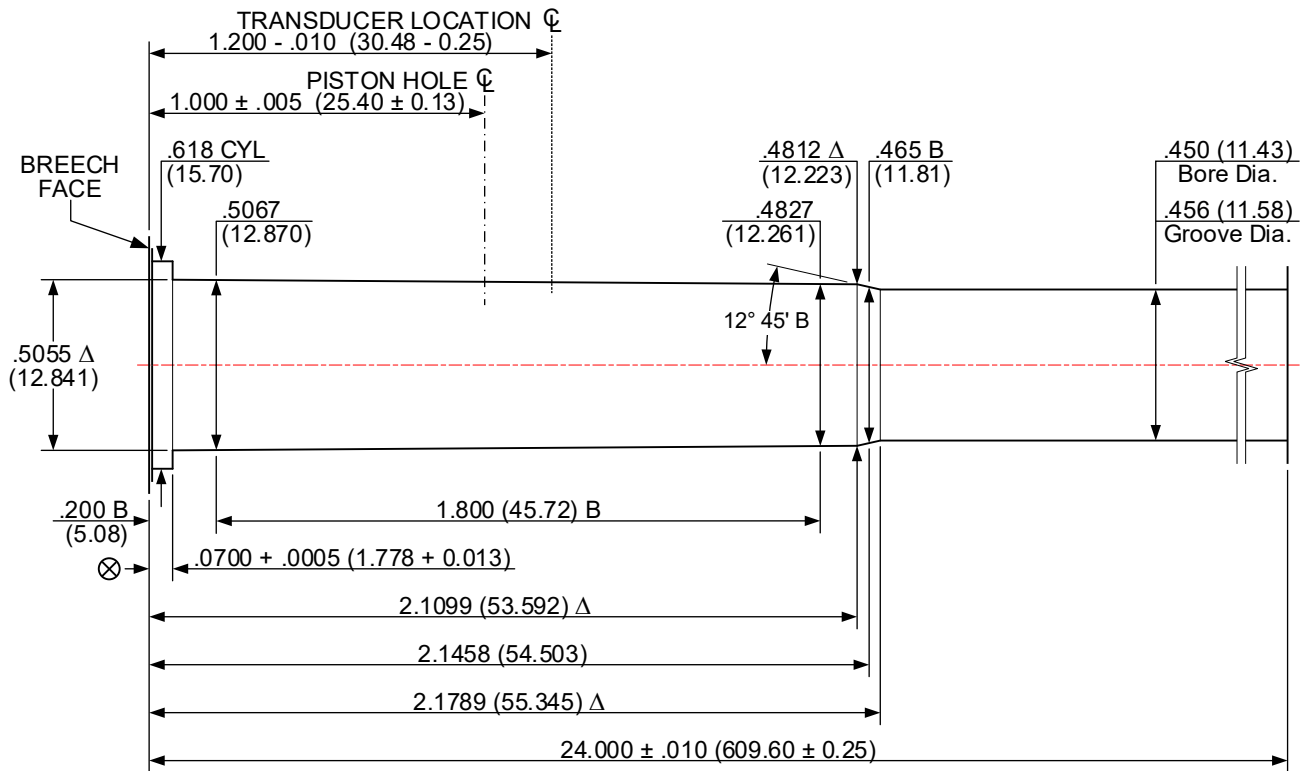

NUMBER OF GROOVES: 6
 WIDTH OF GROOVES: .141 + .002 (3.58 + 0.05)
 TWIST RATE: 20.00 (508.0) R.H.
 DIAMETER OF PISTON HOLE: .206 (5.23)
 TRANSDUCER DIAMETER: .250 (6.53)

LAND AND GROOVE DIMENSIONS TO BE
 WITHIN TOLERANCES THROUGHOUT
 LENGTH OF BARREL.

UNLESS OTHERWISE NOTED,
 ALL DIAMETERS +.0005 (0.013)
 LENGTH TOLERANCE + .005 (0.13)

DO NOT SCALE FROM DRAWING

NOTES:

B = BASIC

Δ = REFERENCE DIMENSION

⊗ = HEADSPACE DIMENSION

* DIMENSIONS ARE TO INTERSECTIONS OF LINES

(XX.XX) = MILLIMETERS

ALL CALCULATIONS APPLY AT MAXIMUM MATERIAL CONDITION (MMC)

450 BUSHMASTER [450 BM]

ISSUED: 09/09/2007 V&P TEST BARREL REVISED: 08/02/2023

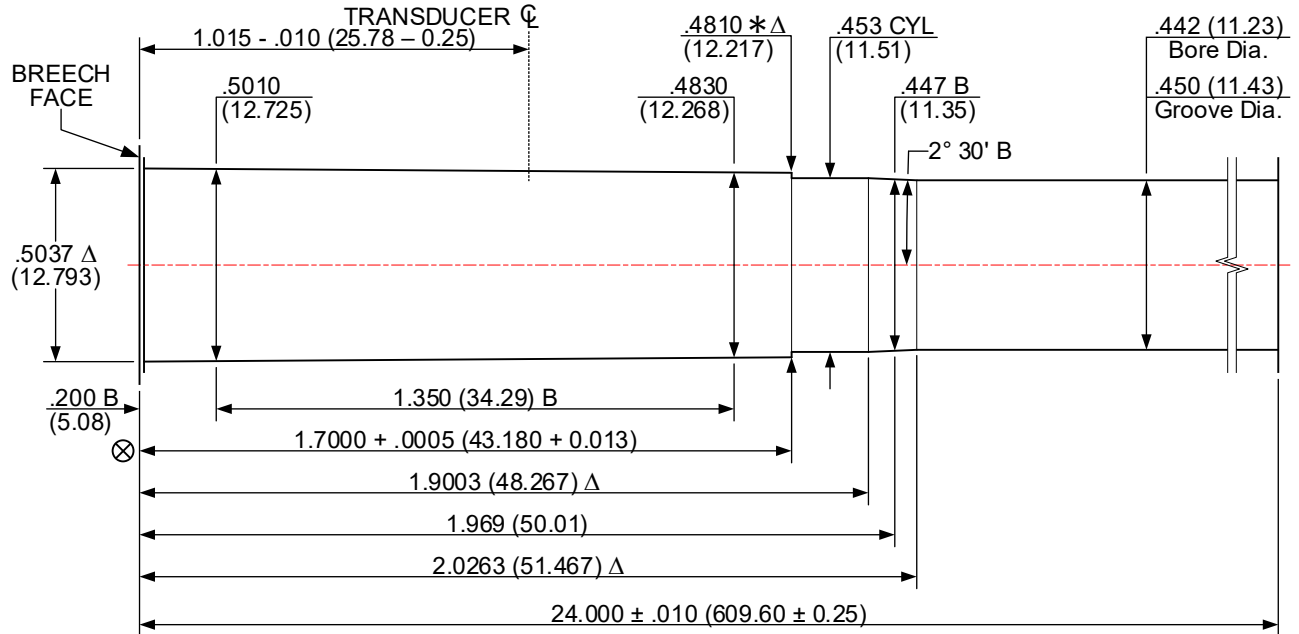

NUMBER OF GROOVES: 6
 WIDTH OF GROOVES: .148 + .002 (3.76 + 0.050)
 TWIST RATE: 24 (609.6) R.H.
 DIAMETER OF PISTON HOLE: Crusher pressures not established
 TRANSDUCER DIAMETER: .250 (6.35)

LAND AND GROOVE DIMENSIONS TO BE
 WITHIN TOLERANCES THROUGHOUT
 LENGTH OF BARREL.

UNLESS OTHERWISE NOTED,
 ALL DIAMETERS +.0005 (0.013)
 LENGTH TOLERANCE + .005 (0.13)

DO NOT SCALE FROM DRAWING

NOTES:

B = BASIC

Δ = REFERENCE DIMENSION

⊗ = HEADSPACE DIMENSION

* DIMENSIONS ARE TO INTERSECTIONS OF LINES

(XX.XX) = MILLIMETERS

ALL CALCULATIONS APPLY AT MAXIMUM MATERIAL CONDITION (MMC)

450 MARLIN [450 MARLIN]
 ISSUED: 01/10/2001 V&P TEST BARREL REVISED: 08/02/2023

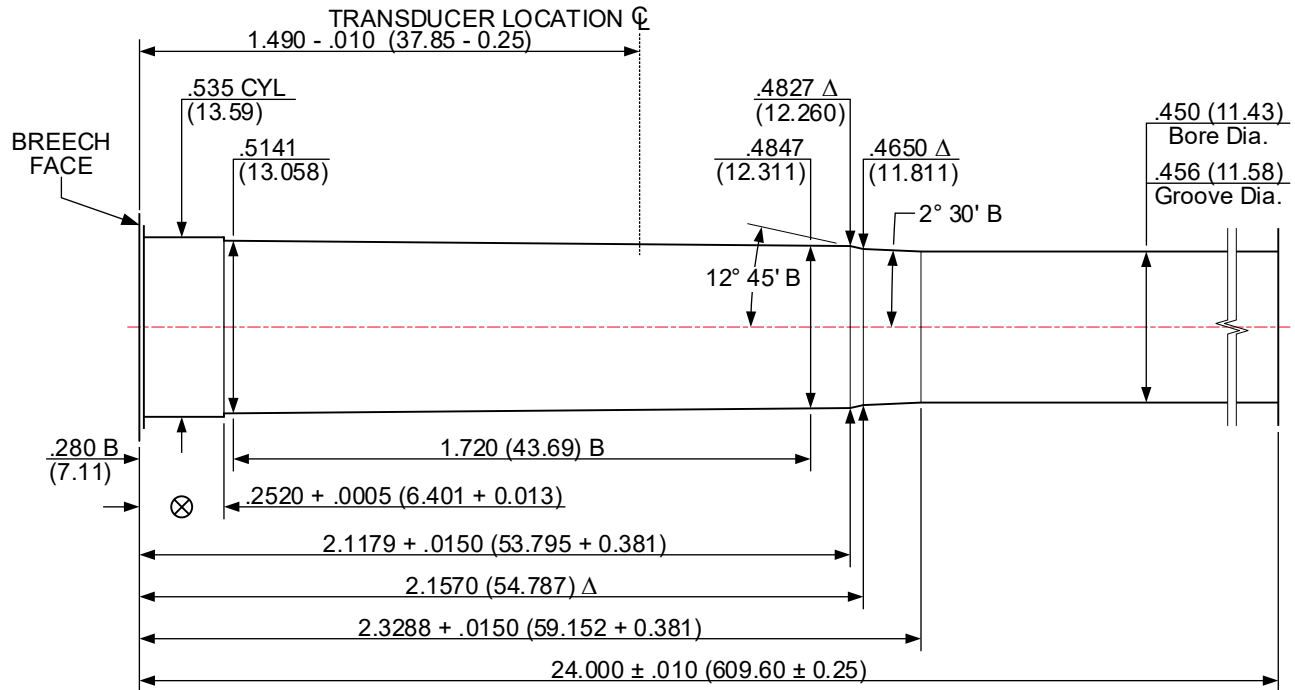

NUMBER OF GROOVES: 6
 WIDTH OF GROOVES: .141 + .002 (3.58 + 0.05)
 TWIST RATE: 20.00 (508.0) R.H.
 DIAMETER OF PISTON HOLE: Crusher pressures not established
 TRANSDUCER DIAMETER: .250 (6.53)

LAND AND GROOVE DIMENSIONS TO BE
 WITHIN TOLERANCES THROUGHOUT
 LENGTH OF BARREL.

UNLESS OTHERWISE NOTED,
 ALL DIAMETERS +.0005 (0.013)
 LENGTH TOLERANCE + .005 (0.13)

DO NOT SCALE FROM DRAWING

NOTES:

B = BASIC

Δ = REFERENCE DIMENSION

⊗ = HEADSPACE DIMENSION

* DIMENSIONS ARE TO INTERSECTIONS OF LINES

(XX.XX) = MILLIMETERS

ALL CALCULATIONS APPLY AT MAXIMUM MATERIAL CONDITION (MMC)

458 LOTT [458 LOTT]
V&P TEST BARREL REVISED: 08/02/2023
 ISSUED: 06/04/1998

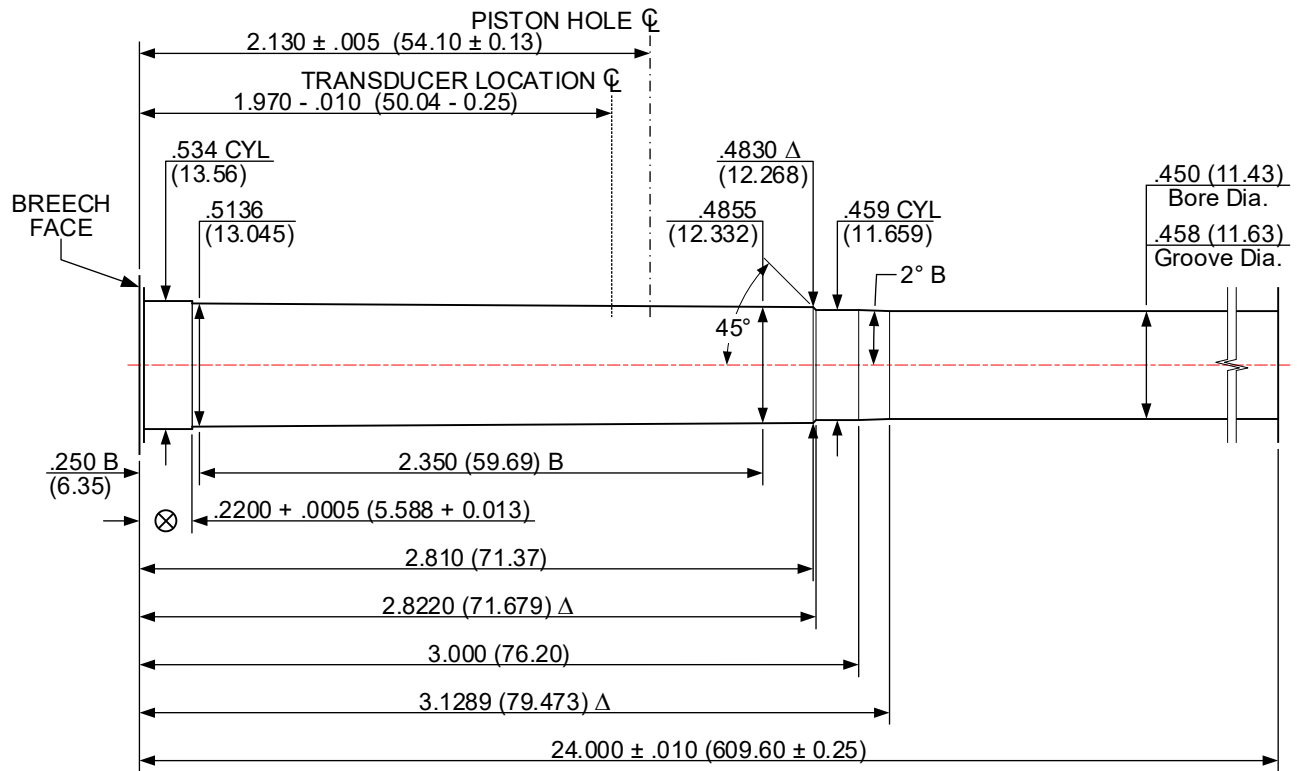

NUMBER OF GROOVES: 6
 WIDTH OF GROOVES: .150 + .002 (3.81 + 0.05)
 TWIST RATE: 10.00 (254.0) R.H.
 DIAMETER OF PISTON HOLE: .206 (5.23)
 TRANSDUCER DIAMETER: .250 (6.53)

LAND AND GROOVE DIMENSIONS TO BE
 WITHIN TOLERANCES THROUGHOUT
 LENGTH OF BARREL.

UNLESS OTHERWISE NOTED,
 ALL DIAMETERS +.0005 (0.013)
 LENGTH TOLERANCE + .005 (0.13)

DO NOT SCALE FROM DRAWING

NOTES:

B = BASIC

Δ = REFERENCE DIMENSION

⊗ = HEADSPACE DIMENSION

* DIMENSIONS ARE TO INTERSECTIONS OF LINES

(XX.XX) = MILLIMETERS

ALL CALCULATIONS APPLY AT MAXIMUM MATERIAL CONDITION (MMC)

458 WINCHESTER MAGNUM [458 WIN MAG]

ISSUED: 05/20/1980 V&P TEST BARREL REVISED: 06/26/2023

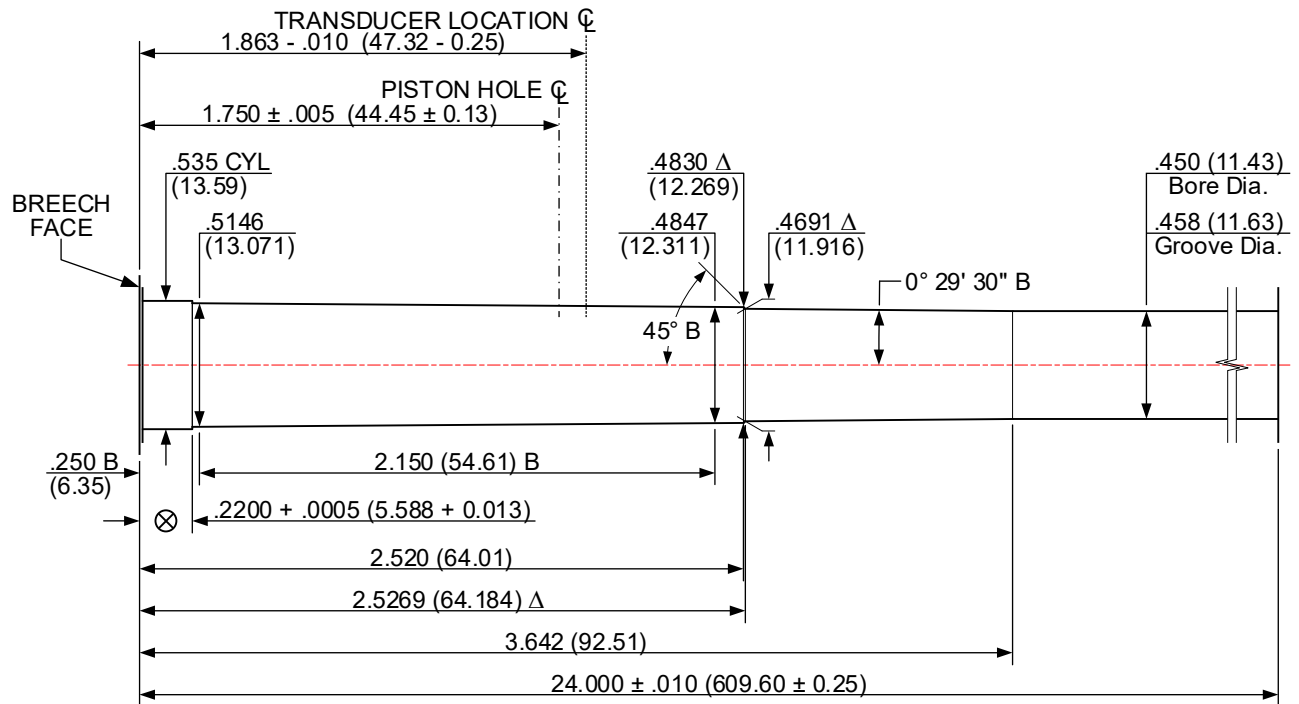

NUMBER OF GROOVES: 6
 WIDTH OF GROOVES: .150 + .002 (3.81 + 0.05)
 TWIST RATE: 14.00 (355.6) R.H.
 DIAMETER OF PISTON HOLE: .206 (5.23)
 TRANSDUCER DIAMETER: .250 (6.53)

LAND AND GROOVE DIMENSIONS TO BE
 WITHIN TOLERANCES THROUGHOUT
 LENGTH OF BARREL.

UNLESS OTHERWISE NOTED,
 ALL DIAMETERS +.0005 (0.013)
 LENGTH TOLERANCE + .005 (0.13)

DO NOT SCALE FROM DRAWING

NOTES:
 B = BASIC Δ = REFERENCE DIMENSION ⊗ = HEADSPACE DIMENSION
 * DIMENSIONS ARE TO INTERSECTIONS OF LINES (XX.XX) = MILLIMETERS
 ALL CALCULATIONS APPLY AT MAXIMUM MATERIAL CONDITION (MMC)

470 NITRO EXPRESS [470 NE]
V&P TEST BARREL REVISED: 08/02/2023

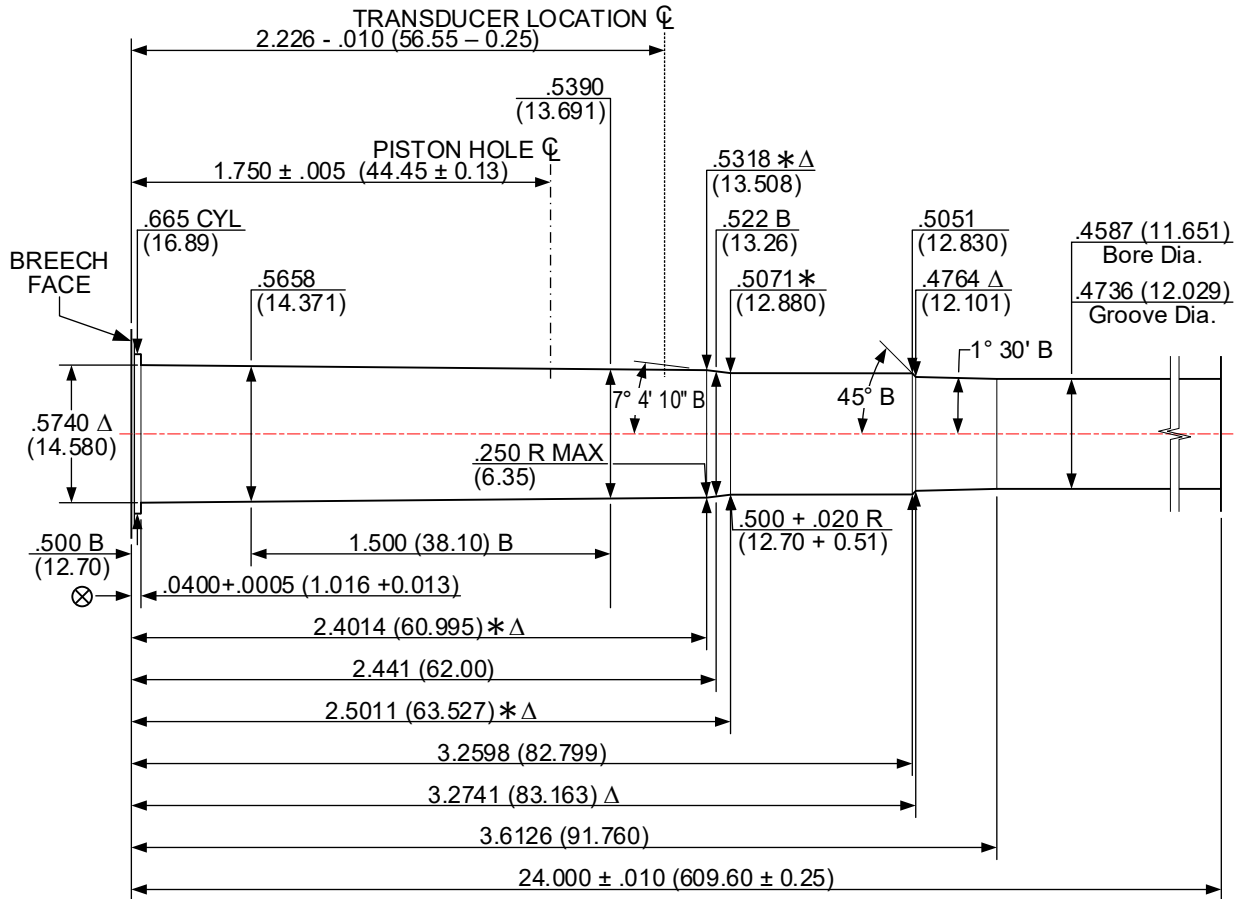

NUMBER OF GROOVES: 6
 WIDTH OF GROOVES: $.160 + .002$ (4.06 + 0.05)
 TWIST RATE: 20.00 (508.0) R.H.
 DIAMETER OF PISTON HOLE: $.206$ (5.23)
 TRANSDUCER DIAMETER: $.250$ (6.35)

LAND AND GROOVE DIMENSIONS TO BE
 WITHIN TOLERANCES THROUGHOUT
 LENGTH OF BARREL.

UNLESS OTHERWISE NOTED,
 ALL DIAMETERS $+ .0005$ (0.013)
 LENGTH TOLERANCE $+ .005$ (0.13)

DO NOT SCALE FROM DRAWING

NOTES:

B = BASIC

Δ = REFERENCE DIMENSION

\otimes = HEADSPACE DIMENSION

* DIMENSIONS ARE TO INTERSECTIONS OF LINES

(XX.XX) = MILLIMETERS

ALL CALCULATIONS APPLY AT MAXIMUM MATERIAL CONDITION (MMC)

DEFINITION AND PURPOSE

SAAMI Definitive Proof cartridges are cartridges commercially loaded by SAAMI member companies which develop pressure substantially exceeding those developed by normal service loads. The pressure levels are designed to assure gun safety when using ammunition loaded to service pressures in accordance with accepted American practices.

Proof cartridges are designed to stress firearms components which contain the cartridge in order to assure safety in the recommended use of the firearm during its service life.

It is important from the safety standpoint that Definitive Proof cartridges be used **only** for the proof of firearms. Adequate precautions must be taken to protect personnel performing firearms proof testing.

The supply of Definitive Proof cartridges will be the responsibility of the company that first introduced that particular caliber to the Institute. Definitive Proof Cartridges should be loaded with the heaviest bullet used at the time of introduction and the slowest powder which will meet the pressure values indicated for that particular cartridge to maintain an effective pressure-distance relationship. Once established, the bullet weight for the proof load does not change unless the bullet becomes obsolete. All changes in Definitive Proof cartridges bullet weight must be approved by the Joint Technical Committee.

NOTE: The heat treatment of cartridge cases for definitive proof loads may be different from the treatment of service cases, at the option of the manufacturer.

Other case modifications to minimize firing casualties such as gas leakage around primers are also permissible. The use of such options must not affect the stressing of the firearm's components.

PROOF PRESSURE INTERPRETATION

The following specifications define the proof loads based on tests fired in standard test barrels with the ammunition at a temperature of 60°-80° F (15.6°-26.7° C). Tests shall be in accordance with the procedures and equipment shown in Sections II and III of this manual.

Pressure values are given on the following pages in terms of minimum and maximum averages and extreme variations for 10-round tests in standard test barrels.

The Standard Deviations for Definitive Proof Cartridges are derived from the Standard Deviations for service loads. A multiplication factor of 1.25 is used to obtain Definitive Proof Load Standard Deviations from Service Load Standard Deviations.

The minimum and maximum average Definitive Proof Pressures are computed as follows:

- The Minimum Average Definitive Proof Pressure is calculated by multiplying the Maximum Probable Lot Mean (MPLM) service pressure by a factor of 1.3 (i.e., 130%) and rounding **UP** to the nearest multiple of 500 psi.
- The Maximum Average Definitive Proof Pressure is calculated by multiplying the Maximum Probable Lot Mean (MPLM) service pressure by a factor of 1.4 (i.e., 140%) and rounding **DOWN** to the nearest multiple of 500 psi.
- The Proof Maximum Extreme Variation (EV) is calculated by multiplying the Proof Standard Deviation (which in the case of Centerfire Rifle is equal to the Service Standard Deviation multiplied by 1.25) by the constant 5.16⁽¹⁹⁾ and rounding **UP** to the next 100 psi.
- The Minimum Proof Individual (MPI) pressure is positioned three standard deviations (proof) below the Minimum Average Definitive Proof Pressure, with the calculated value being rounded **DOWN** to the next multiple of 100 psi.

Example (using transducer data):

Cartridge: 222 Remington MPLM Pressure = 51,300 psi $\sigma_{\text{SERVICE}} = 2,000$ psi

1. Definitive Proof Load Standard Deviation (σ_{PROOF}) =
Service Load Standard Deviation (σ_{SERVICE}) x 1.25
i.e.: 2,000 psi x 1.25 = 2,500 psi
2. Min. Avg. Proof Pressure = Maximum Probable Lot Mean Pressure x 1.30
i.e.: 51,300 psi x 1.30 = 66,690 psi rounded **up** to nearest 500 psi = 67,000 psi
3. Max. Avg Proof Pressure = Maximum Probable Lot Mean Pressure x 1.40
i.e.; 51,300 psi x 1.40 = 71,820 psi rounded **down** to nearest 500 psi = 71,500 psi
4. Max. Proof E.V. = Proof Standard Deviation ($\sigma_{\text{(PROOF)}}$) x 5.16
i.e.: 2,500 psi x 5.16 = 12,900 psi rounded **up** to next 100 psi = 12,900 psi
5. Minimum Proof Individual = Min. Avg. Proof Pressure – (3 x $\sigma_{\text{(PROOF)}}$)
i.e., 67,000 psi – (3 x 2,500 psi) = 59,500 psi rounded **down** to next 100 psi = 59,400 psi

¹⁹ The Maximum Proof Pressure EV is a statistic derived from knowledge of the population standard deviation. Applying table figures from Relative Range Tables (Biometrika Tables for Statisticians), we calculate the maximum EV, or *Range*, equal to the population S.D. times the table constant 5.16 (for a sample of 10 at 99.0% confidence level).

PROOF PRESSURE DATA - CRUSHER

Cartridge	Bullet Weight (grains)	SERVICE	Pressure Values of Proof Cartridges ⁽¹⁾		
		Maximum Average Pressure (CUP/100)	Minimum Average (CUP/100)	Maximum Average (CUP/100)	Maximum E.V. (CUP/100)
6mm Advanced Rifle Cartridge	108	Crusher Pressures Not Established			
6mm Creedmoor	108	Crusher Pressures Not Established			
6mm GT	109	Crusher Pressures Not Established			
6mm Remington	100	520	695	745	135
6.5 Creedmoor	140	Crusher Pressures Not Established			
6.5 Grendel	123	Crusher Pressures Not Established			
6.5 Precision Rifle Cartridge	147	Crusher Pressures Not Established			
6.5 Weatherby Rebrated Precision Magnum	140	Crusher Pressures Not Established			
6.5-284 Norma	130	Crusher Pressures Not Established			
6.5-300 Weatherby Magnum	127	Crusher Pressures Not Established			
6.5 x 55 Swedish	140	460	615	660	119
6.8 True Velocity Composite	135	Crusher Pressures Not Established			
6.8 Western	175	Crusher Pressures Not Established			
6.8mm Remington SPC	115	Crusher Pressures Not Established			
7mm Mauser (7x57)	175	460	615	660	119
7mm Precision Rifle Cartridge	180	Crusher Pressures Not Established			
7mm Remington Magnum	175	520	695	745	135
7mm Remington Short Action Ultra Magnum	160	Crusher Pressures Not Established			
7mm Remington Ultra Magnum	140	Crusher Pressures Not Established			
7mm Weatherby Magnum	175	Crusher Pressures Not Established			
7mm Winchester Short Magnum	150	Crusher Pressures Not Established			
7mm-08 Remington	140	520	695	745	135
7 x 64 Brenneke	175	505	675	725	131
7.62 x 39	123	500	670	715	129
8mm Mauser (8x57)	170	370	495	530	96
9.3 x 62	286	Crusher Pressures Not Established			
17 Hornet	20	Crusher Pressures Not Established			
17 Remington	25	520	695	745	135
17 Remington Fireball	20	Crusher Pressures Not Established			
204 Ruger	32	Crusher Pressures Not Established			
218 Bee	46	400	535	570	104
22 Advanced Rifle Cartridge	75	Crusher Pressures Not Established			
22 Creedmoor	80	Crusher Pressures Not Established			
22 Hornet	45	430	575	615	111
22 Nosler	55	Crusher Pressures Not Established			
22-250 Remington	55	530	710	760	137
220 Swift	60	540	725	775	140
221 Remington Fireball	50	520	695	745	135
222 Remington	55	460	615	660	119
222 Remington Magnum	55	500	670	715	129

⁽¹⁾ Based on sample size $n=1$.

PROOF PRESSURE DATA - CRUSHER (Continued)

Cartridge	Bullet Weight (grains)	SERVICE	Pressure Values of Proof Cartridges ⁽¹⁾		
		Maximum	Minimum	Maximum	Maximum
		Average Pressure (CUP/100)	Average (CUP/100)	Average (CUP/100)	E.V. (CUP/100)
223 Remington	64	520	695	745	135
223 Winchester Super Short Magnum	64	Crusher Pressures Not Established			
224 Valkyrie	90	Crusher Pressures Not Established			
243 Winchester	100	520	695	745	135
243 Winchester Super Short Magnum	100	Crusher Pressures Not Established			
25 Winchester Super Short Magnum	85	Crusher Pressures Not Established			
25-06 Remington	120	530	710	760	137
25-20 Winchester	86	280	375	400	73
25-35 Winchester	117	370	495	530	96
250 Savage	100	450	600	645	117
257 Roberts		Obsolete – Use 257 Roberts +P Only			
257 Roberts +P	117	500	670	715	129
257 Weatherby Magnum	120	535	715	765	139
26 Nosler	129	Crusher Pressures Not Established			
260 Remington	120	Crusher Pressures Not Established			
264 Winchester Magnum	140	540	725	775	140
27 Nosler	150	Crusher Pressures Not Established			
270 Weatherby Magnum	150	535	715	765	139
270 Winchester	150	520	695	745	135
270 Winchester Short Magnum	150	Crusher Pressures Not Established			
277 SIG Fury	135	Crusher Pressures Not Established			
28 Nosler	168	Crusher Pressures Not Established			
280 Ackley Improved	140	Crusher Pressures Not Established			
280 Remington	165	500	670	715	129
284 Winchester	150	540	725	775	140
30 Carbine	110	400	535	570	104
30 Nosler	210	Crusher Pressures Not Established			
30 Remington AR	125	Crusher Pressures Not Established			
30 Thompson Center	150	Crusher Pressures Not Established			
30-06 Springfield	220	500	670	715	129
30-30 Winchester	170	380	510	545	99
30-40 Krag	180	400	535	570	104

⁽¹⁾ Based on sample size $n=1$.

PROOF PRESSURE DATA - CRUSHER (Continued)

Cartridge	Bullet Weight (grains)	SERVICE	Pressure Values of Proof Cartridges ⁽¹⁾		
		Maximum Average Pressure (CUP/100)	Minimum Average (CUP/100)	Maximum Average (CUP/100)	Maximum E.V. (CUP/100)
300 AAC BLACKOUT	220	Crusher Pressures Not Established			
300 HAM'R	130	Crusher Pressures Not Established			
300 Holland & Holland Magnum	180	540	725	775	140
300 Norma Magnum	230	Crusher Pressures Not Established			
300 Precision Rifle Cartridge	225	Crusher Pressures Not Established			
300 Remington Short Action Ultra Magnum	180	Crusher Pressures Not Established			
300 Remington Ultra Magnum	200	Crusher Pressures Not Established			
300 Ruger Compact Magnum	180	Crusher Pressures Not Established			
300 Savage	180	460	615	660	119
300 Weatherby Magnum	220	Crusher Pressures Not Established			
300 Winchester Magnum	220	540	725	775	140
300 Winchester Short Magnum	180	Crusher Pressures Not Established			
303 British	180	450	600	645	117
307 Winchester	150	520	695	745	135
308 Marlin Express	160	Crusher Pressures Not Established			
308 Winchester	180	520	695	745	135
32 Winchester Special	170	380	510	545	99
32-20 Winchester	100	160	215	225	42
325 Winchester Short Magnum	220	Crusher Pressures Not Established			
33 Nosler	250	Crusher Pressures Not Established			
338 Federal	210	Crusher Pressures Not Established			
338 Lapua Magnum	250	Crusher Pressures Not Established			
338 Marlin Express	200	Crusher Pressures Not Established			
338 Norma Magnum	300	Crusher Pressures Not Established			
338 Remington Ultra Magnum	250	Crusher Pressures Not Established			
338 Ruger Compact Magnum	225	Crusher Pressures Not Established			
338 Weatherby Rebased Precision Magnum	225	Crusher Pressures Not Established			
338 Winchester Magnum	250	540	725	775	140
340 Weatherby Magnum	250	535	715	765	139
348 Winchester	200	400	535	570	104
35 Remington	200	350	470	500	91
35 Whelen	250	520	695	745	135
350 Legend	145	Crusher Pressures Not Established			
356 Winchester	250	520	695	745	135
358 Winchester	200	520	695	745	135
360 Buckhammer	200	Crusher Pressures Not Established			
370 Sako Magnum	286	Crusher Pressures Not Established			

⁽¹⁾ Based on sample size $n=1$.

PROOF PRESSURE DATA - CRUSHER (Continued)

Cartridge	Bullet Weight (grains)	SERVICE Maximum Average Pressure (CUP/100)	Pressure Values of Proof Cartridges⁽¹⁾		
			Minimum Average (CUP/100)	Maximum Average (CUP/100)	Maximum E.V. (CUP/100)
375 Holland & Holland Magnum	300	530	710	760	137
375 Remington Ultra Magnum	300	Crusher Pressures Not Established			
375 Ruger	300	Crusher Pressures Not Established			
375 Winchester	250	520	695	745	135
376 Steyr	270	Crusher Pressures Not Established			
38-40 Winchester	180	140	190	200	37
38-55 Winchester	255	300	405	430	78
400 Legend	215	Crusher Pressures Not Established			
405 Winchester	300	Crusher Pressures Not Established			
416 Remington Magnum	400	540	725	775	140
416 Rigby		Crusher Pressures Not Established			
416 Ruger	400	Crusher Pressures Not Established			
416 Weatherby Magnum	400	535	715	765	139
44 Remington Magnum	240	400	535	570	104
44-40 Winchester	200	130	175	185	34
444 Marlin	240	440	590	630	114
45-70 Government	405	280	375	400	73
450 Bushmaster	250	Crusher Pressures Not Established			
450 Marlin	350	Crusher Pressures Not Established			
458 Lott	465	Crusher Pressures Not Established			
458 Winchester Magnum	510	530	710	760	137
470 Nitro Express	500	350	470	500	91
500 Nitro Express 3"	570	Crusher Pressures Not Established			

⁽¹⁾ Based on sample size $n=1$.

PROOF PRESSURE DATA - TRANSDUCER

Cartridge	Bullet Weight (grains)	SERVICE Maximum	Pressure Values of Proof Cartridges ⁽¹⁾		
		Average Pressure (psi/100)	Minimum Average (psi/100)	Maximum Average (psi/100)	Maximum E.V. (psi/100)
6mm Advanced Rifle Cartridge	108	520	695	745	135
6mm Creedmoor	108	620	830	890	160
6mm GT	109	620	830	890	160
6mm Remington	100	650	870	930	168
6.5 Creedmoor	140	620	830	890	160
6.5 Grendel	123	520	695	745	135
6.5 Precision Rifle Cartridge	147	650	870	930	168
6.5 Weatherby Rebased Precision Magnum	140	650	870	930	168
6.5-284 Norma	130	580	775	830	150
6.5-300 Weatherby Magnum	127	650	870	930	168
6.5 x 55 Swedish	140	510	680	730	132
6.8 True Velocity Composite	135	700	935	1005	181
6.8 Western	175	650	870	930	168
6.8mm Remington SPC	115	550	735	785	142
7mm Mauser (7x57)	175	510	680	730	132
7mm Precision Rifle Cartridge	180	650	870	930	168
7mm Remington Magnum	175	610	815	875	158
7mm Remington Short Action Ultra Magnum	160	650	870	930	168
7mm Remington Ultra Magnum	140	650	870	930	168
7mm Weatherby Magnum	175	650	870	930	168
7mm Winchester Short Magnum	150	650	870	930	168
7mm-08 Remington	140	610	815	875	158
7 x 64 Brenneke	175	550	735	785	142
7.62 x 39	123	450	600	645	117
8mm Mauser (8x57)	170	350	470	500	91
9.3 x 62	220	575	770	825	149
17 Hornet	20	500	670	715	129
17 Remington	25	630	840	900	163
17 Remington Fireball	20	550	735	785	142
204 Ruger	32	575	770	825	149
218 Bee	46	Transducer Pressures Not Established			
22 Advanced Rifle Cartridge	75	520	695	745	135
22 Creedmoor	80	620	830	890	160
22 Hornet	45	490	655	700	127
22 Nosler	55	550	735	785	142
22-250 Remington	55	650	870	930	168
220 Swift	60	620	830	890	160
221 Remington Fireball	50	600(T)	800	860	155
222 Remington	55	500	670	715	129
222 Remington Magnum	55	550	735	785	142

⁽¹⁾ Based on sample size $n=1$.

PROOF PRESSURE DATA - TRANSDUCER (Continued)

Cartridge	Bullet Weight (grains)	SERVICE Maximum Average Pressure (psi/100)	Pressure Values of Proof Cartridges ⁽¹⁾		
			Minimum Average (psi/100)	Maximum Average (psi/100)	Maximum E.V. (psi/100)
223 Remington	64	550	735	785	142
223 Winchester Super Short Magnum	64	650	870	930	168
224 Valkyrie	90	550	735	785	142
243 Winchester	100	600	800	860	155
243 Winchester Super Short Magnum	100	650	870	930	168
25 Winchester Super Short Magnum	85	650	870	930	168
25-06 Remington	120	630	840	900	163
25-20 Winchester	86	Transducer Pressures Not Established			
25-35 Winchester	117	Transducer Pressures Not Established			
250 Savage	100	Transducer Pressures Not Established			
257 Roberts			Obsolete – Use 257 Roberts +P Only		
257 Roberts +P	117	580	775	830	150
257 Weatherby Magnum	120	625	835	895	162
26 Nosler	129	650	870	930	168
260 Remington	120	600	800	860	155
264 Winchester Magnum	140	640	855	915	166
27 Nosler	150	650	870	930	168
270 Weatherby Magnum	150	625	835	895	162
270 Winchester	150	650	870	930	168
270 Winchester Short Magnum	150	650	870	930	168
277 SIG Fury	135	800	1070	1145	207
28 Nosler	168	650	870	930	168
280 Ackley Improved	140	650	870	930	168
280 Remington	165	600	800	860	155
284 Winchester	150	560	750	800	145
30 Carbine	110	400	535	570	104
30 Nosler	210	650	870	930	168
30 Remington AR	125	550	735	785	142
30 Thompson Center	150	620	830	890	160
30-06 Springfield	220	600	800	860	155
30-30 Winchester	170	420	565	600	109
30-40 Krag	180	Transducer Pressures Not Established			

⁽¹⁾ Based on sample size $n=1$.

PROOF PRESSURE DATA - TRANSDUCER (Continued)

Cartridge	Bullet Weight (grains)	SERVICE Maximum Average Pressure (psi/100)	Pressure Values of Proof Cartridges ⁽¹⁾		
			Minimum Average (psi/100)	Maximum Average (psi/100)	Maximum E.V. (psi/100)
300 AAC Blackout	220	550	735	785	142
300 HAM'R	130	575	770	825	149
300 Holland & Holland Magnum	180	580	775	830	150
300 Norma Magnum	230	610	815	875	158
300 Precision Rifle Cartridge	225	650	870	930	168
300 Remington Short Action Ultra Magnum	180	650	870	930	168
300 Remington Ultra Magnum	200	650	870	930	168
300 Ruger Compact Magnum	180	650	870	930	168
300 Savage	180	470	630	670	122
300 Weatherby Magnum	220	650	870	930	168
300 Winchester Magnum	220	640	855	915	166
300 Winchester Short Magnum	180	650	870	930	168
303 British	180	490	655	700	127
307 Winchester	150	Transducer Pressures Not Established			
308 Marlin Express	160	475	635	680	123
308 Winchester	180	620	830	890	160
32 Winchester Special	170	420	565	600	109
32-20 Winchester	100	Transducer Pressures Not Established			
325 Winchester Short Magnum	220	650	870	930	168
33 Nosler	250	650	870	930	168
338 Federal	210	620	830	890	160
338 Lapua Magnum	250	650	870	930	168
338 Marlin Express	200	460	615	660	119
338 Norma Magnum	300	625	835	895	162
338 Remington Ultra Magnum	250	650	870	930	168
338 Ruger Compact Magnum	225	650	870	930	168
338 Weatherby Rebated Precision Magnum	225	650	870	930	168
338 Winchester Magnum	250	640	855	915	166
340 Weatherby Magnum	250	625	835	895	162
348 Winchester	200	450	600	645	117
35 Remington	200	335	450	480	87
35 Whelen	250	620	830	890	160
350 Legend	145	550	735	785	142
356 Winchester	250	Transducer Pressures Not Established			
358 Winchester	200	Transducer Pressures Not Established			
360 Buckhammer	200	500	670	715	129
370 Sako Magnum	286	600	800	860	155

⁽¹⁾ Based on sample size $n=1$.

PROOF PRESSURE DATA - TRANSDUCER (Continued)

Cartridge	Bullet Weight (grains)	SERVICE Maximum Average Pressure (psi/100)	Pressure Values of Proof Cartridges⁽¹⁾		
			Minimum Average (psi/100)	Maximum Average (psi/100)	Maximum E.V. (psi/100)
375 Holland & Holland Magnum	300	620	830	890	160
375 Remington Ultra Magnum	300	650	870	930	168
375 Ruger	300	620	830	890	160
375 Winchester	250	Transducer Pressures Not Established			
376 Steyr	270	620	830	890	160
38-40 Winchester	180	Transducer Pressures Not Established			
38-55 Winchester	255	Transducer Pressures Not Established			
400 Legend	215	450	600	645	117
405 Winchester	300	460	615	660	119
416 Remington Magnum	400	650	870	930	168
416 Rigby		520	695	745	135
416 Ruger	400	620	830	890	160
416 Weatherby Magnum	400	Transducer Pressures Not Established			
44 Remington Magnum	240	360	480	515	93
44-40 Winchester	200	110	150	155	29
444 Marlin	240	420	565	600	109
45-70 Government	405	280	375	400	73
450 Bushmaster	250	385	515	550	100
450 Marlin	350	435	580	620	113
458 Lott	465	625	835	895	162
458 Winchester Magnum	510	600	800	860	155
470 Nitro Express	500	410	550	585	106
500 Nitro Express 3"	570	385	515	550	100

⁽¹⁾ Based on sample size $\eta=1$.

PROOF LOAD SUPPLY

NOTE: Refer to Section III, page 233, *Supplier Contact Information*, for detailed information on contacting the manufacturers of listed products and the SAAMI Technical Office.

Centerfire rifle Definitive Proof Loads should be used for one purpose only: the proof testing of Centerfire rifles.

A list of current proof load suppliers may be obtained from the SAAMI website at www.saami.org.

PROOF CARTRIDGE IDENTIFICATION

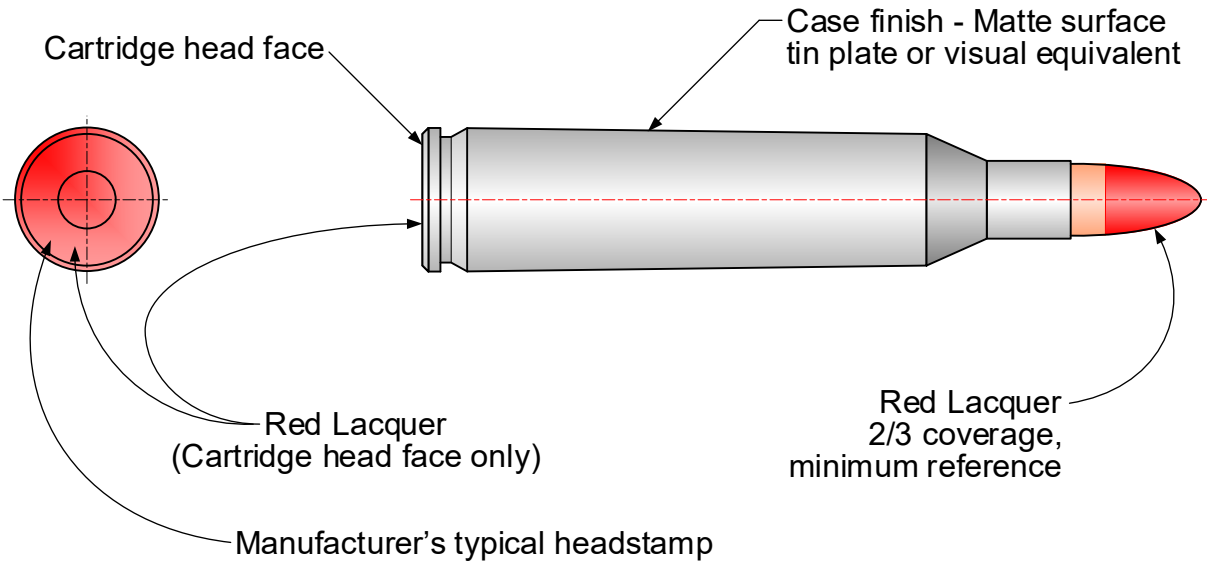

DEFINITIVE PROOF PACKAGE IDENTIFICATION

HIGH PRESSURE PROOF LOADS

For Gun Manufacturers' Proof Test Use Only: Fire only from fixed rest with operator properly protected from injury should the firearm be damaged. Purchaser should restrict proof loads to manufacturing premises. To dispose of proof loads, contact the producer for instructions.

DO NOT reload or dispose of fired proof shells in a manner that may make them available for reloading. **Failure to follow the foregoing can result in personal injury.**

Centerfire proof loads are identified by a tin-plated case (or visual equivalent) with red lacquer on the bullet and case head face.

For consistent results, proof loads should be stored for 2 weeks at $70^{\circ}\text{F} \pm 5^{\circ}$ ($21.1^{\circ} \pm 2.8^{\circ}\text{C}$), and 60% relative humidity before use.

"WARNING: KEEP OUT OF REACH OF CHILDREN"

(Red lettering on white background)